

# Virtual Memory

# Learning Outcomes

- An understanding of page-based virtual memory in depth.
  - Including the R3000's support for virtual memory.

# Memory Management Unit (or TLB)

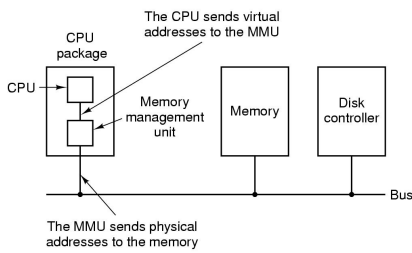

The position and function of the MMU

# Paging

- Virtual Memory
  - Divided into equal-sized pages
  - A mapping is a translation between
    - A page and a frame
    - A page and null
  - Mappings defined at runtime
    - They can change
  - Address space can have holes
  - Process does not have to be contiguous in physical memory
- Physical Memory
  - Divided into equal-sized frames

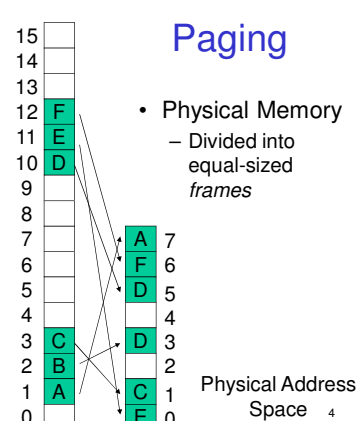

# Typical Address Space Layout

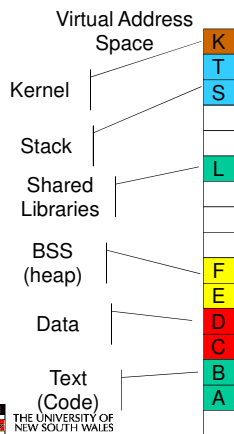

- Stack region is at top, and can grow down
- Heap has free space to grow up
- Text is typically read-only
- Kernel is in a reserved, protected, shared region
- 0-th page typically not used, why?

**Programmer's perspective:** logically present  
**System's perspective:** Not mapped, data on disk

- A process may be only partially resident
  - Allows OS to store individual pages on disk
  - Saves memory for infrequently used data & code
- What happens if we access non-resident memory?

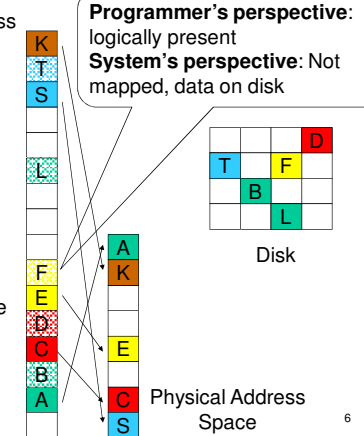

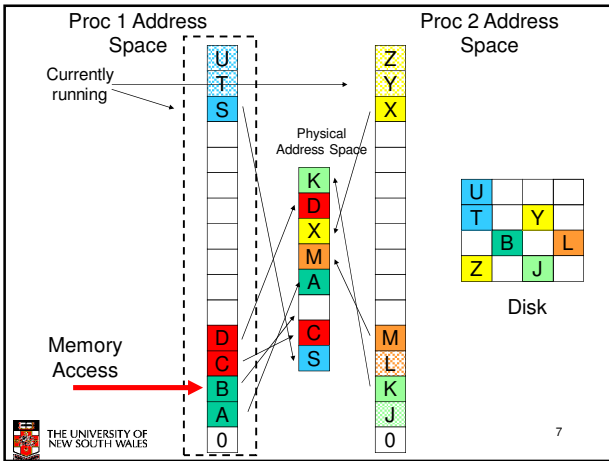

## Page Faults

- Referencing an invalid page triggers a page fault
  - An exception handled by the OS
- Broadly, two standard page fault types
  - Illegal Address (protection error)
    - Signal or kill the process
  - Page not resident
    - Get an empty frame
    - Load page from disk
    - Update page (translation) table (enter frame #, set valid bit, etc.)
    - Restart the faulting instruction

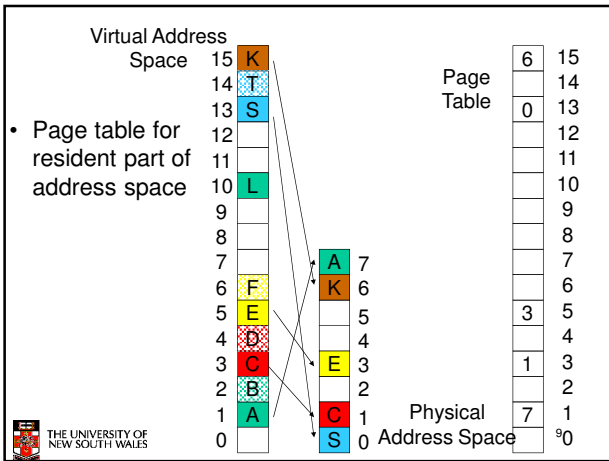

## Shared Pages

- Private code and data
  - Each process has own copy of code and data
  - Code and data can appear anywhere in the address space
- Shared code
  - Single copy of code shared between all processes executing it
  - Code must not be self-modifying
  - Code must appear at same address in all processes

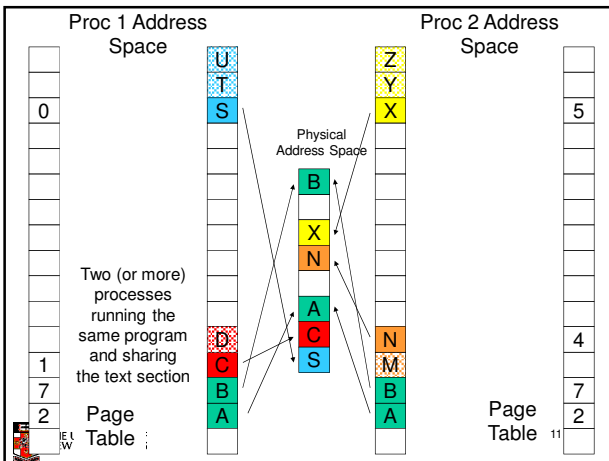

## Page Table Structure

- Page table is (logically) an array of frame numbers
  - Index by page number
- Each page-table entry (PTE) also has other bits
  - Caching disabled
  - Modified
  - Present/absent
  - Referenced
  - Protection

## PTE Attributes (bits)

- Present/Absent bit
  - Also called *valid bit*, it indicates a valid mapping for the page
- Modified bit
  - Also called *dirty bit*, it indicates the page may have been modified in memory
- Reference bit
  - Indicates the page has been accessed
- Protection bits
  - Read permission, Write permission, Execute permission
  - Or combinations of the above
- Caching bit
  - Use to indicate processor should bypass the cache when accessing memory
    - Example: to access device registers or memory

## Address Translation

- Every (virtual) memory address issued by the CPU must be translated to physical memory
  - Every *load* and every *store* instruction
  - Every instruction fetch
- Need Translation Hardware
- In paging system, translation involves replace page number with a frame number

## Virtual Memory Summary

virtual and physical mem chopped up in pages/frames

- programs use virtual addresses
- virtual to physical mapping by MMU
  - first check if page present (present/absent bit)
  - if yes: address in page table form MSBs in physical address
  - if no: bring in the page from disk  
→ page fault

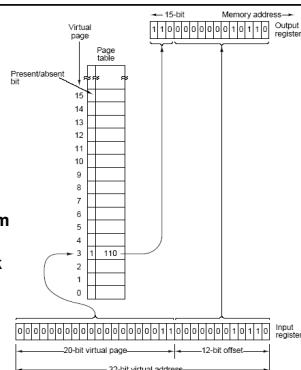

## Page Tables

- Assume we have
  - 32-bit virtual address (4 Gbyte address space)
  - 4 KByte page size
  - How many page table entries do we need for one process?

## Page Tables

- Assume we have
  - 64-bit virtual address (humungous address space)
  - 4 KByte page size
  - How many page table entries do we need for one process?
- Problem:
  - Page table is very large
  - Access has to be fast, lookup for every memory reference
  - Where do we store the page table?
    - Registers?
    - Main memory?

## Page Tables

- Page tables are implemented as data structures in main memory
- Most processes do not use the full 4GB address space
  - e.g., 0.1 – 1 MB text, 0.1 – 10 MB data, 0.1 MB stack
- We need a compact representation that does not waste space
  - But is still very fast to search
- Three basic schemes
  - Use data structures that adapt to sparsity
  - Use data structures which only represent resident pages
  - Use VM techniques for page tables (details left to extended OS)

## Two-level Page Table

- 2<sup>nd</sup>-level page tables representing unmapped pages are not allocated
  - Null in the top-level page table

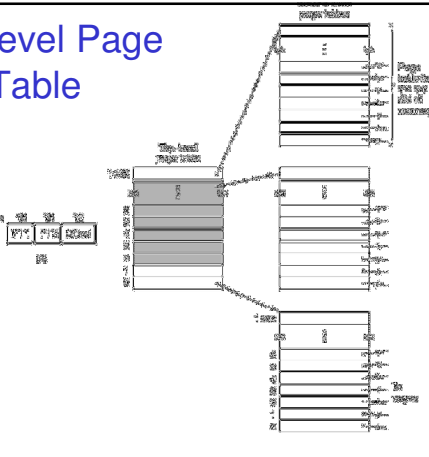

## Two-level Translation

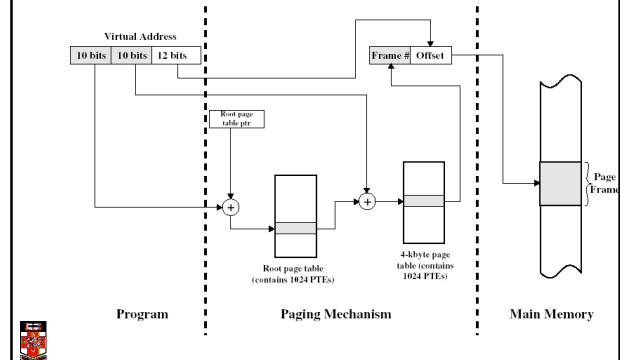

## Example Translations

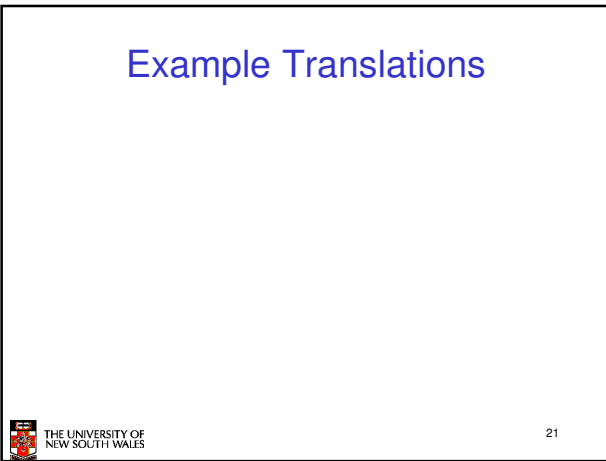

## Alternative: Inverted Page Table

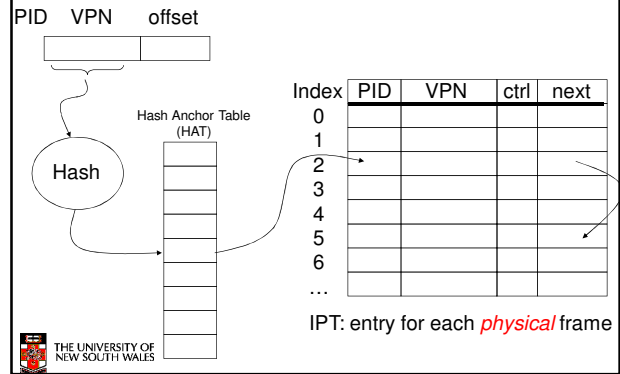

## Alternative: Inverted Page Table

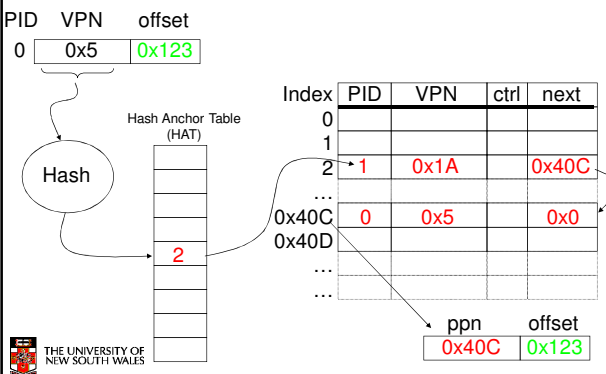

## Inverted Page Table (IPT)

- "Inverted page table" is an array of page numbers sorted (indexed) by frame number (it's a frame table).
- Algorithm
  - Compute hash of page number
  - Extract index from hash table
  - Use this to index into inverted page table
  - Match the PID and page number in the IPT entry
  - If match, use the index value as frame # for translation
  - If no match, get next candidate IPT entry from chain field
  - If NULL chain entry  $\Rightarrow$  page fault

## Properties of IPTs

- IPT grows with size of RAM, NOT virtual address space
- Frame table is needed anyway (for page replacement, more later)
- Need a separate data structure for non-resident pages
- Saves a vast amount of space (especially on 64-bit systems)
- Used in some IBM and HP workstations

## Given $n$ processes

- how many page tables will the system have for
  - ‘normal’ page tables
  - inverted page tables?

## Another look at sharing...

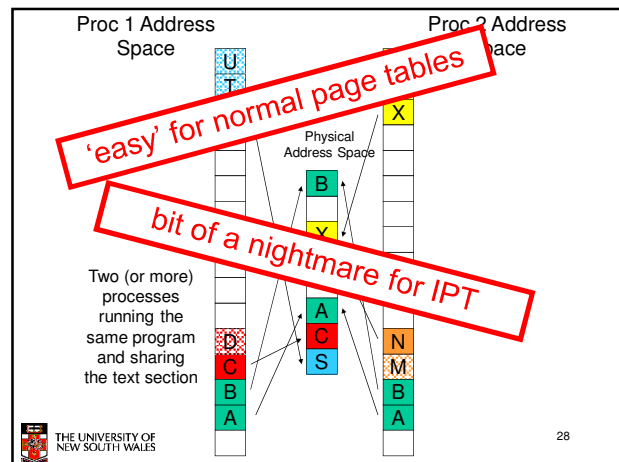

## VM Implementation Issue

- Problem:
  - Each virtual memory reference can cause two physical memory accesses
    - One to fetch the page table entry
    - One to fetch/store the data
  - ⇒ Intolerable performance impact!!
- Solution:
  - High-speed cache for page table entries (PTEs)
    - Called a *translation look-aside buffer* (TLB)
    - Contains recently used page table entries
    - Associative, high-speed memory, similar to cache memory
    - May be under OS control (unlike memory cache)

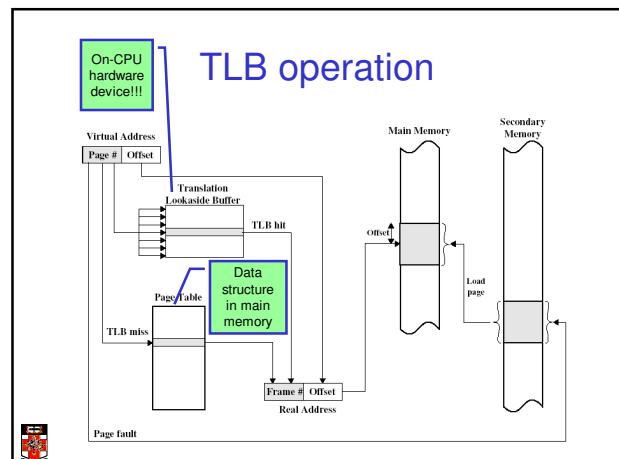

## Translation Lookaside Buffer

- Given a virtual address, processor examines the TLB
- If matching PTE found (*TLB hit*), the address is translated
- Otherwise (*TLB miss*), the page number is used to index the process's page table
  - If PT contains a valid entry, reload TLB and restart
  - Otherwise, (page fault) check if page is on disk
    - If on disk, swap it in
    - Otherwise, allocate a new page or raise an exception

## TLB properties

- Page table is (logically) an array of frame numbers
- TLB holds a (recently used) subset of PT entries
  - Each TLB entry must be identified (tagged) with the page # it translates
  - Access is by associative lookup:
    - All TLB entries' tags are concurrently compared to the page #
    - TLB is associative (or content-addressable) memory

page #	frame #	V	W
...	...	.	.
...	...	.	.

## TLB properties

- TLB may or may not be under direct OS control
  - Hardware-loaded TLB
    - On miss, hardware performs PT lookup and reloads TLB
    - Example: x86, ARM
  - Software-loaded TLB
    - On miss, hardware generates a TLB miss exception, and exception handler reloads TLB
    - Example: MIPS, Itanium (optionally)
- TLB size: typically 64-128 entries
- Can have separate TLBs for instruction fetch and data access
- TLBs can also be used with inverted page tables (and others)

## TLB and context switching

- TLB is a shared piece of hardware
- Normal page tables are per-process (address space)
- TLB entries are *process-specific*
  - On context switch need to *flush* the TLB (invalidate all entries)
    - high context-switching overhead (Intel x86)
  - or tag entries with *address-space ID* (ASID)
    - called a *tagged TLB*
    - used (in some form) on all modern architectures
    - TLB entry: ASID, page #, frame #, valid and write-protect bits

## TLB effect

- Without TLB
  - Average number of physical memory references per virtual reference = 2
- With TLB (assume 99% hit ratio)
  - Average number of physical memory references per virtual reference =  $.99 * 1 + 0.01 * 2$
  - = 1.01

## Recap - Simplified Components of VM System

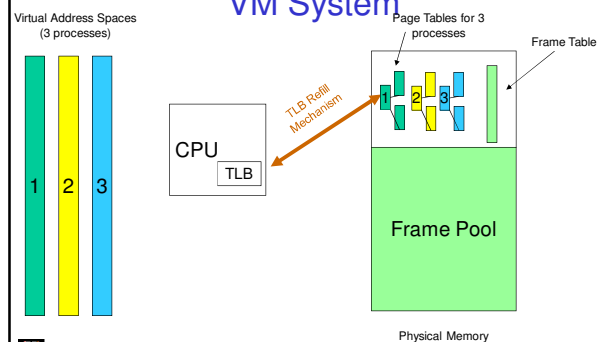

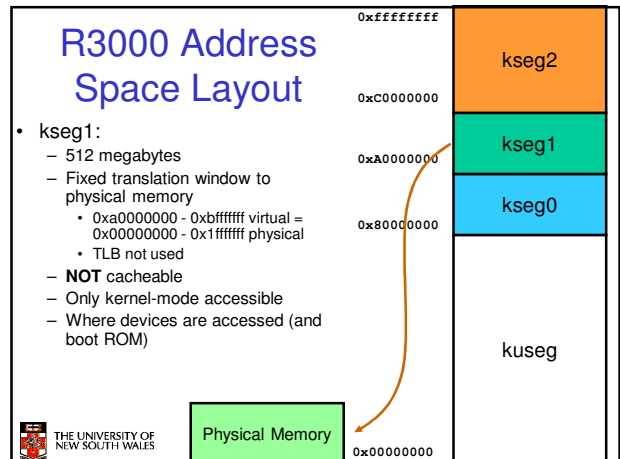
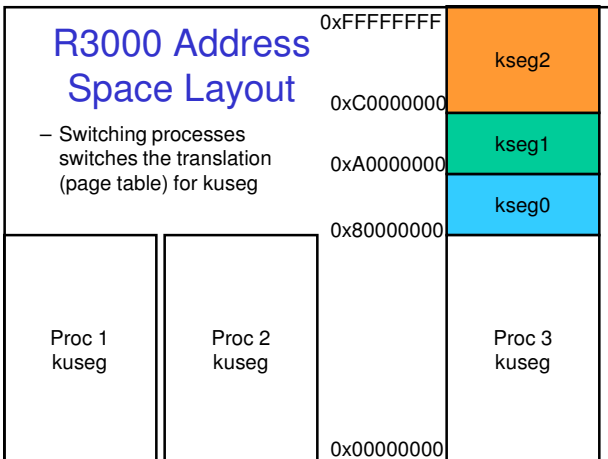
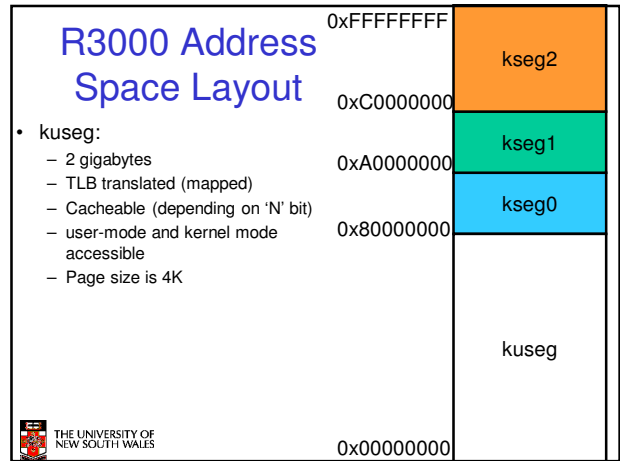
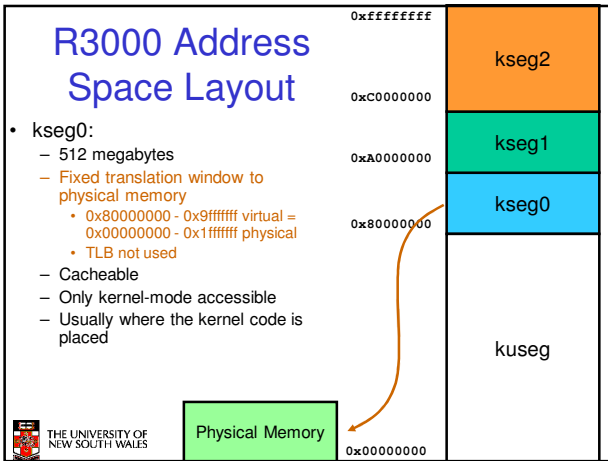
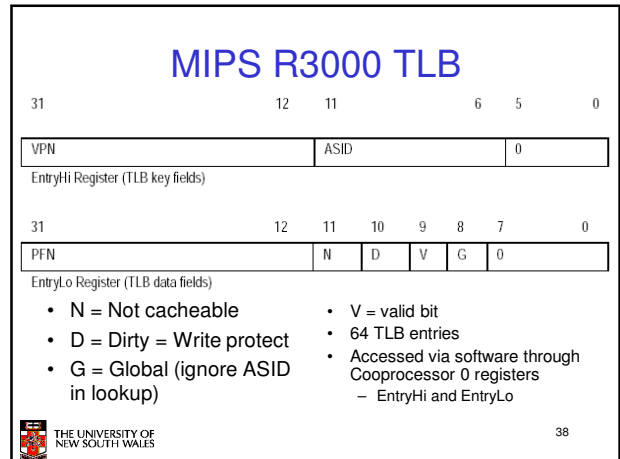
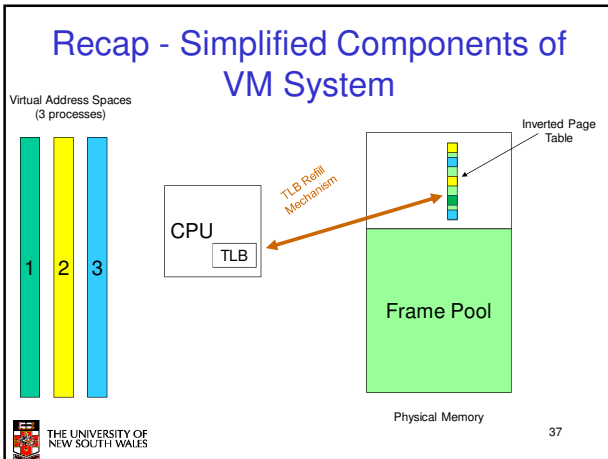

## R3000 Address Space Layout

- kseg2:
  - 1024 megabytes
  - TLB translated (mapped)
  - Cacheable
    - Depending on the 'N'-bit
  - Only kernel-mode accessible
  - Can be used to store the virtual linear array page table

