

# Scheduler Activations



# Learning Outcomes

- An understanding of hybrid approaches to thread implementation
- A high-level understanding of scheduler activations, and how they overcome the limitations of user-level and kernel-level threads.



- Thomas Anderson, Brian Bershad, Edward Lazowska, and Henry Levy. Scheduler Activations: Effective Kernel Support for the User-Level management of Parallelism. *ACM Trans. on Computer Systems* 10(1), February 1992, pp. 53-79.



# User-level Threads

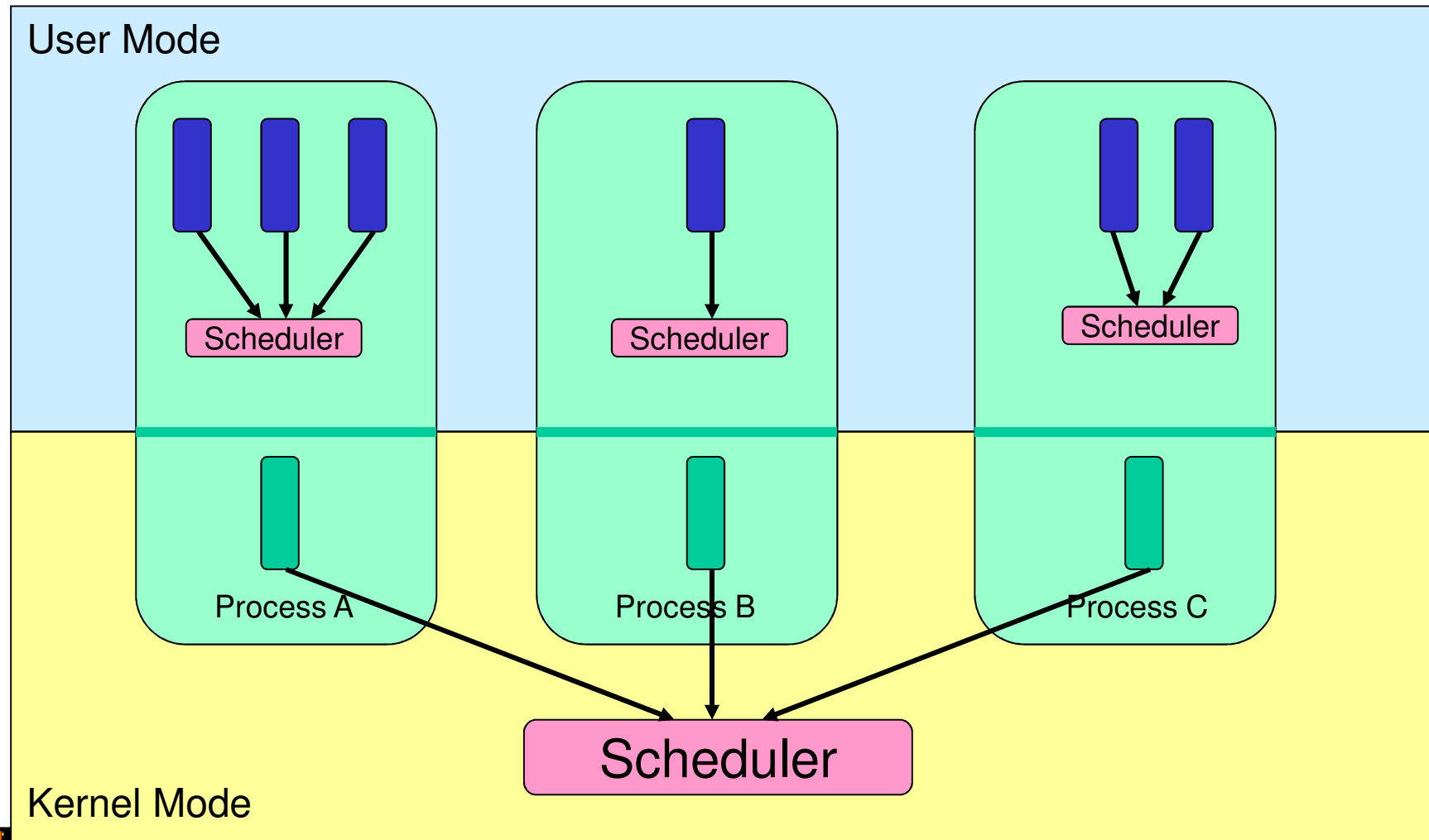

# User-level Threads

- ✓ Fast thread management (creation, deletion, switching, synchronisation...)
- ✗ Blocking blocks all threads in a process
  - Syscalls
  - Page faults
- ✗ No thread-level parallelism on multiprocessor



# Kernel-Level Threads

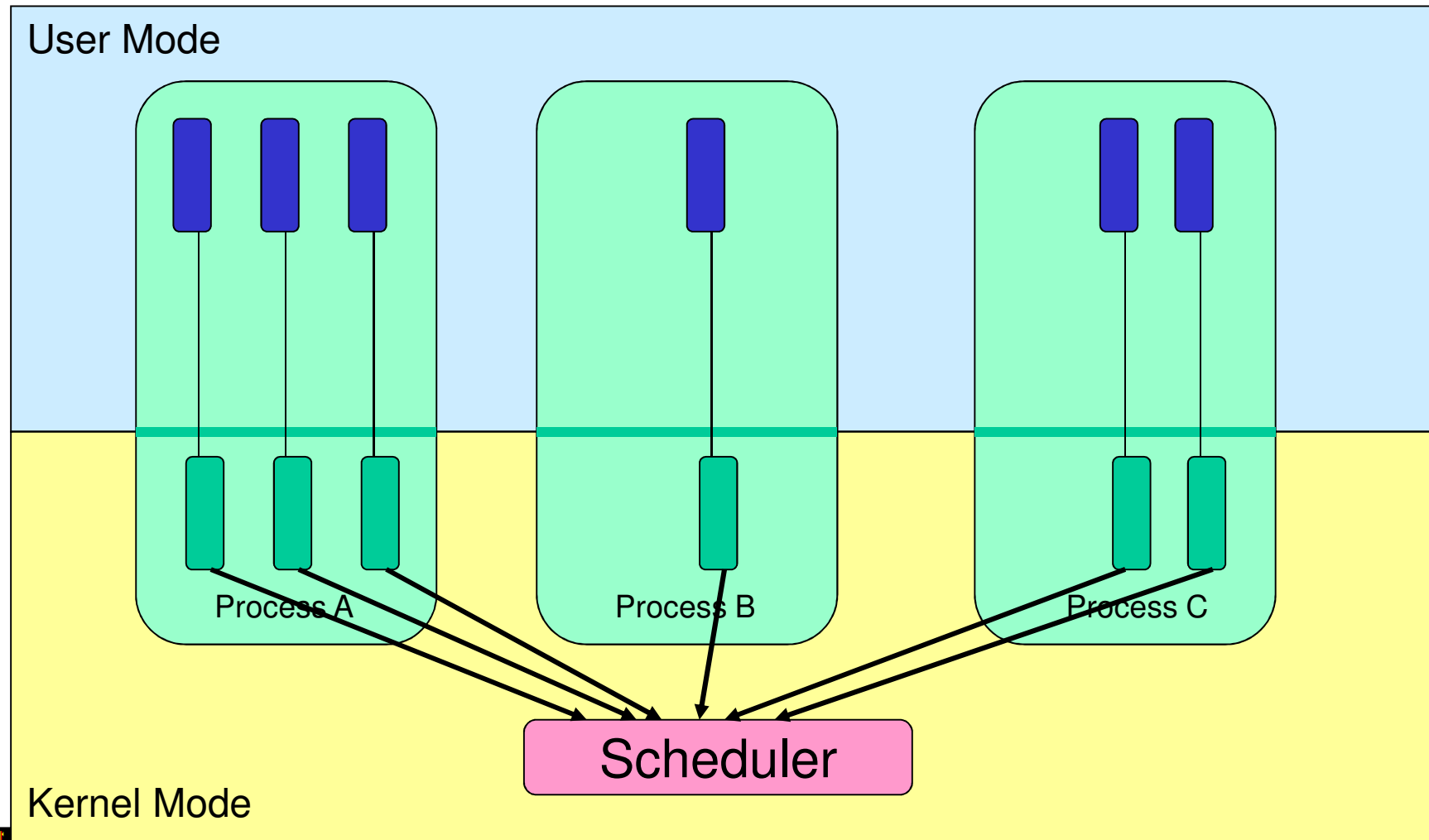

# Kernel-level Threads

- ✗ Slow thread management (creation, deletion, switching, synchronisation...)
  - System calls
- ✓ Blocking blocks only the appropriate thread in a process
- ✓ Thread-level parallelism on multiprocessor



# Performance

Table I: Thread Operation Latencies ( $\mu\text{sec.}$ )

Operation	FastThreads	Topaz threads	Ulrix processes
Null Fork	34	948	11300
Signal-Wait	37	441	1840

User-level threads

Kernel-level threads





# Hybrid Multithreading

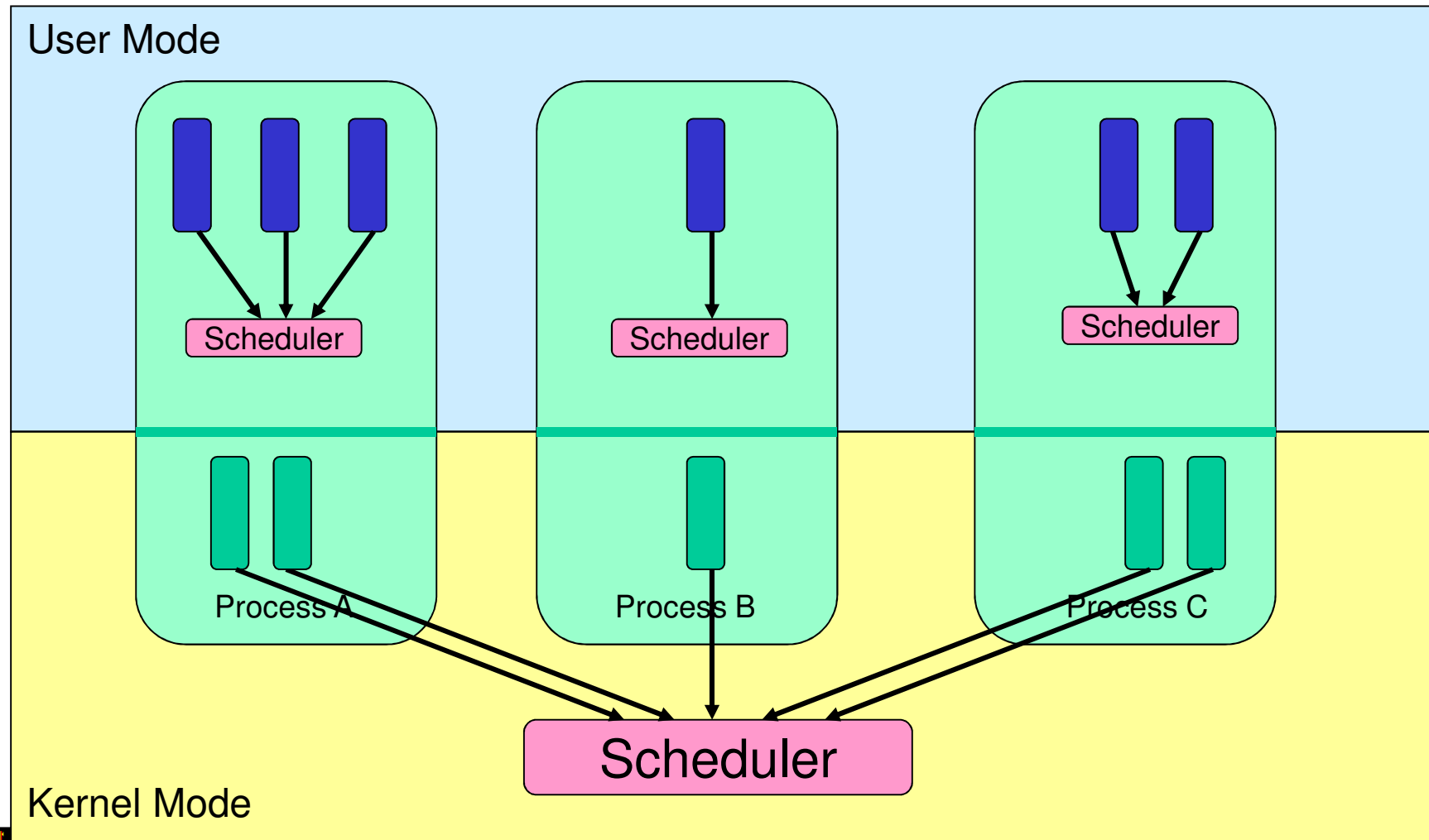

# Hybrid Multithreading

- ✓ Can get real thread parallelism on multiprocessor
- ✗ Blocking still a problem!!!



# Scheduler Activations

- First proposed by [Anderson et al. 91]
- Idea: Both schedulers co-operate
  - User scheduler uses system calls
  - **Kernel scheduler uses upcalls!**
- Two important concepts
  - Upcalls
    - Notify the user-level of kernel scheduling events
  - Activations
    - A new structure to support upcalls and execution
      - approximately a kernel thread
    - As many running activations as (allocated) processors
    - Kernel controls activation creation and destruction



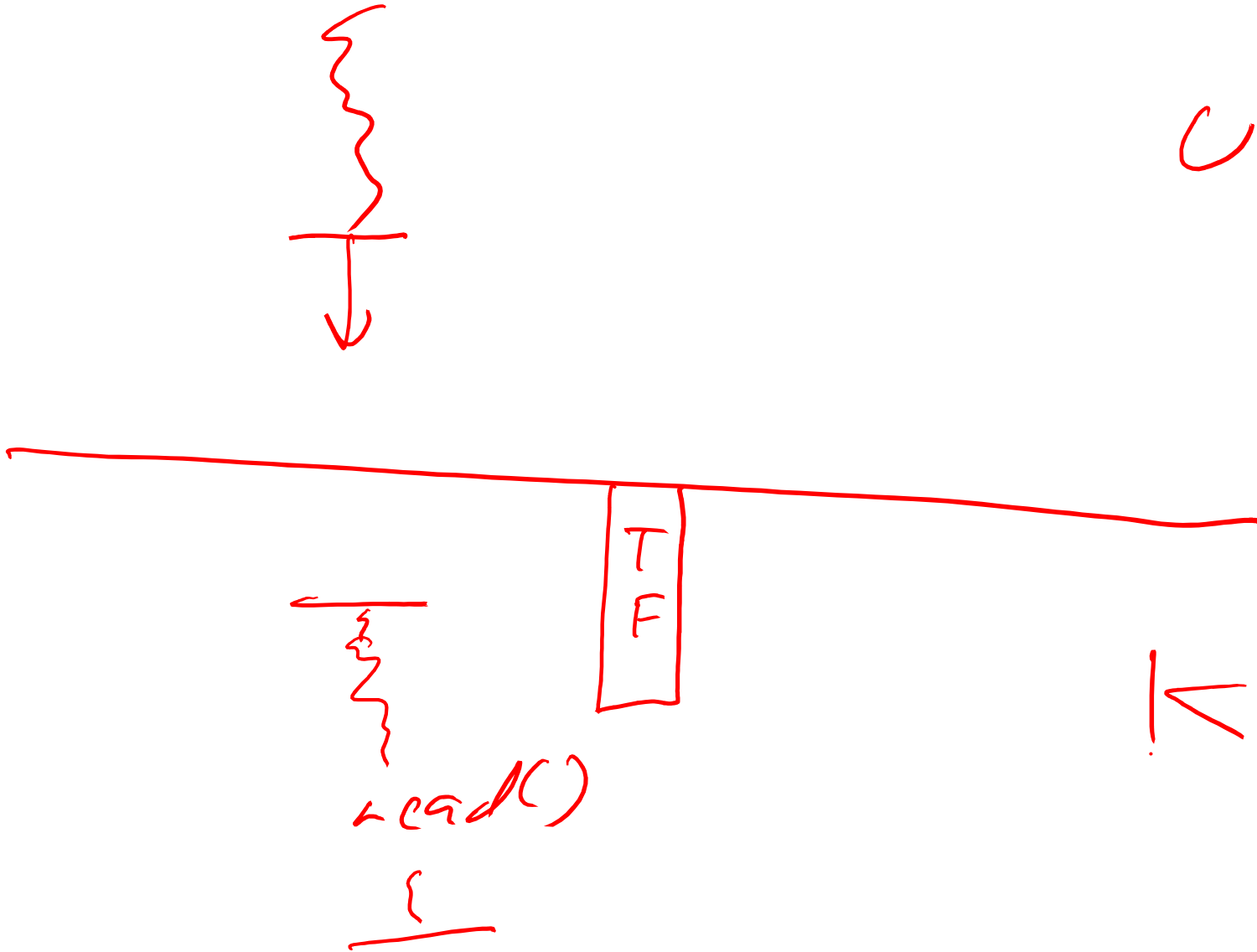

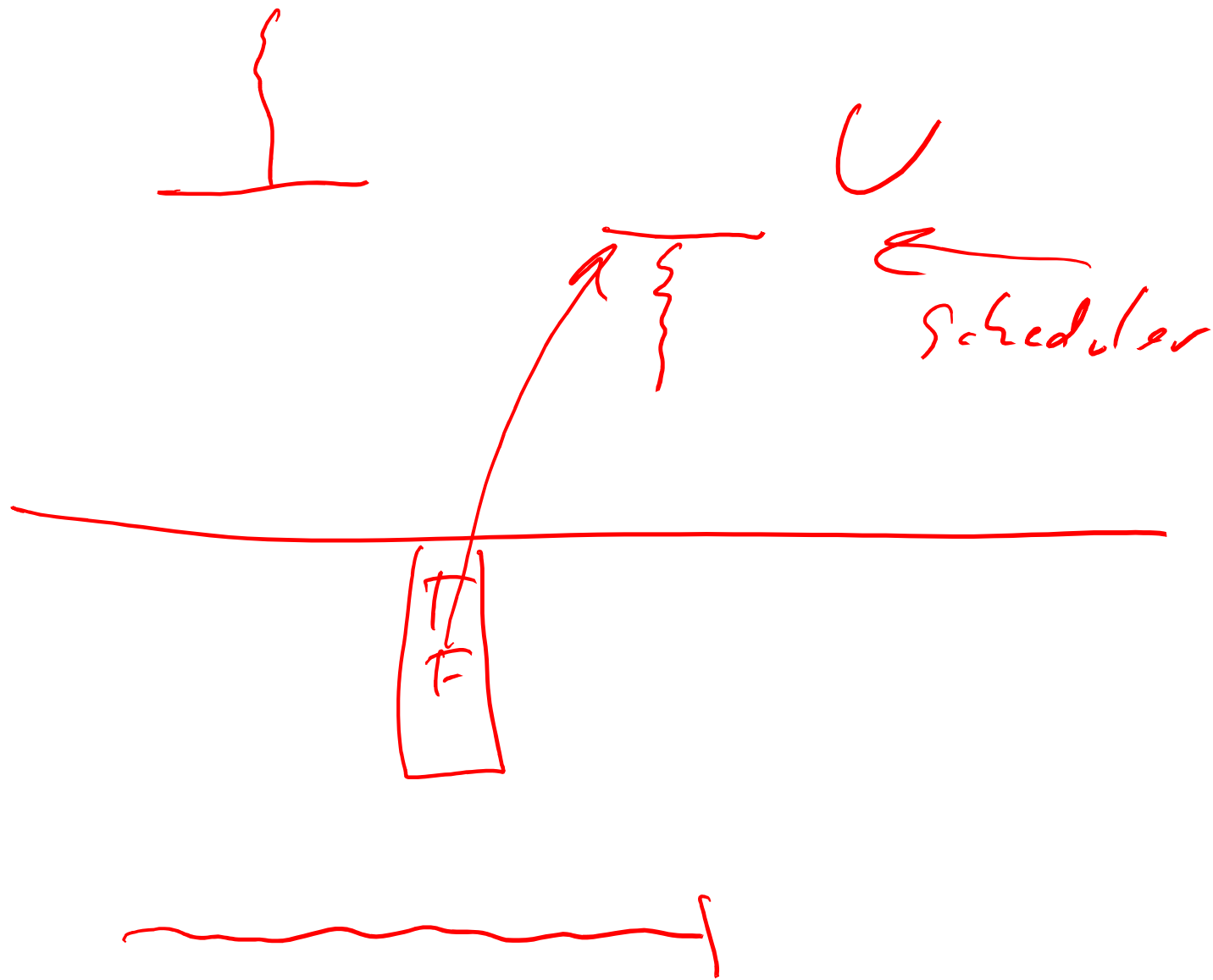



# Scheduler Activations

- Instead of **CPU time wasted**

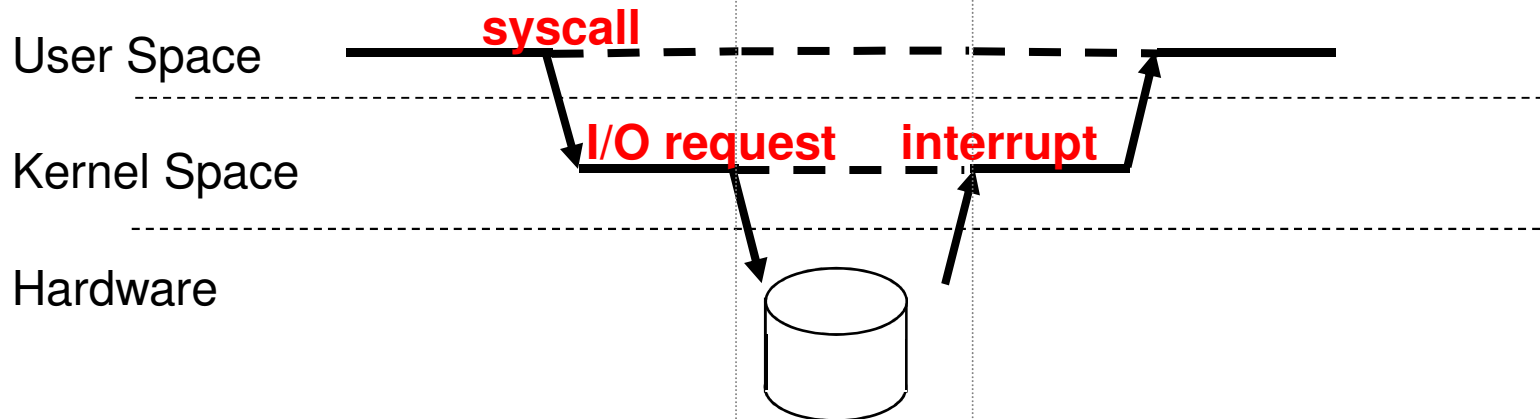

- ...rather use the following scheme:

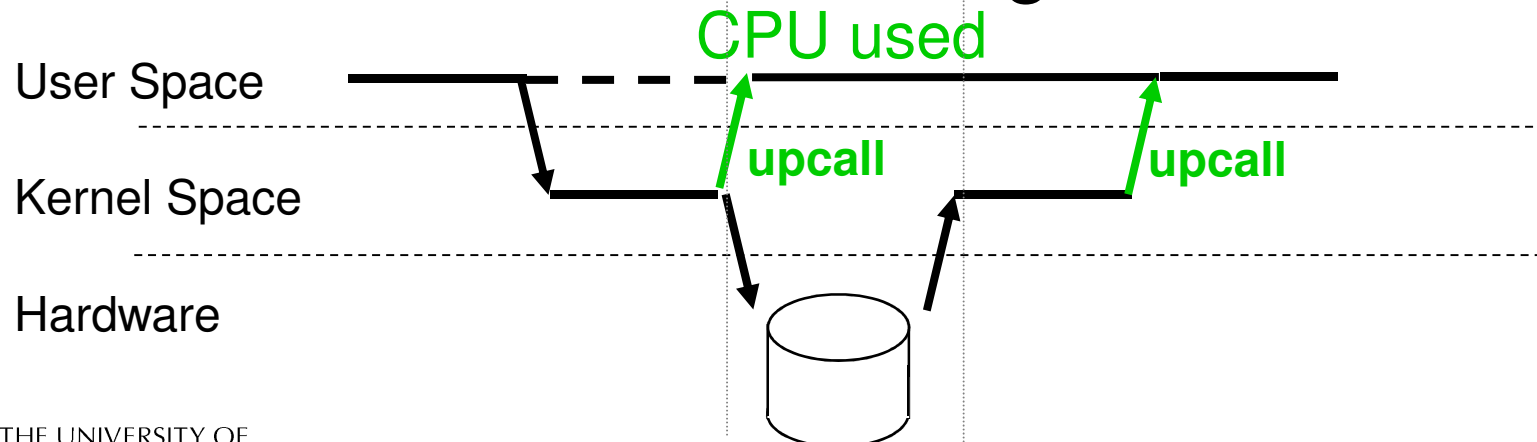

# Upcalls to User-level scheduler

- **New** (processor #)
  - Allocated a new virtual CPU
  - Can schedule a user-level thread
- **Preempted** (activation # and its machine state)
  - Deallocated a virtual CPU
  - Can schedule one less thread
- **Blocked** (activation #)
  - Notifies thread has blocked
  - Can schedule another user-level thread
- **Unblocked** (activation # and its machine state)
  - Notifies a thread has become runnable
  - Must decided to continue current or unblocked thread





# Working principle

- Blocking syscall scenario on 2 processors

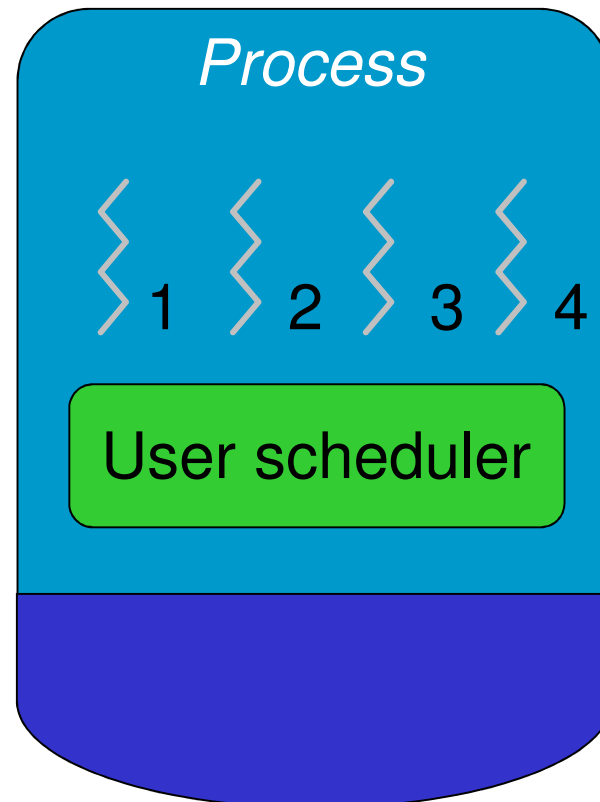

# Working principle

- Blocking syscall scenario on 2 processors

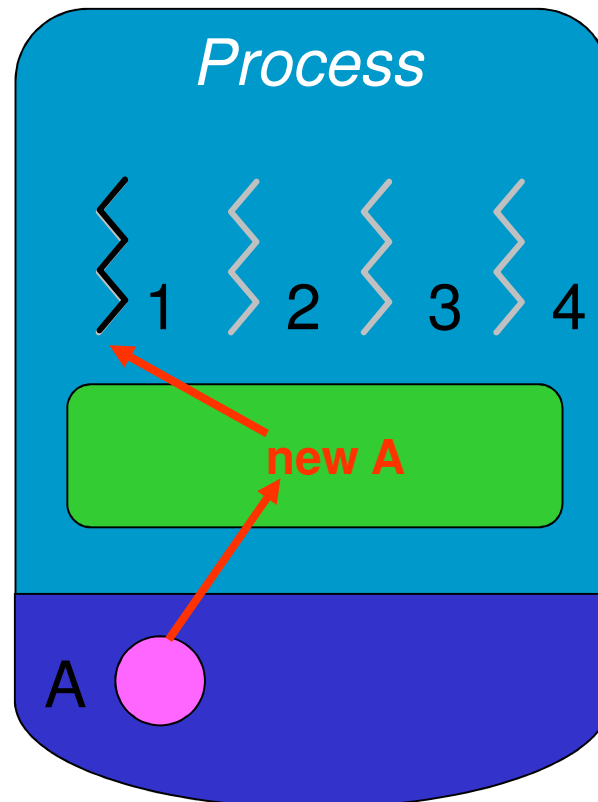

# Working principle

- Blocking syscall scenario on 2 processors

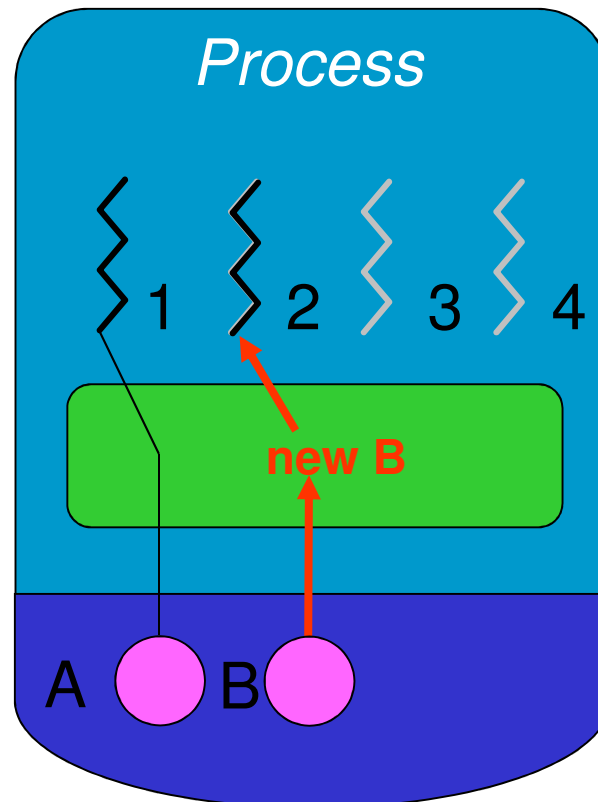

# Working principle

- Blocking syscall scenario on 2 processors

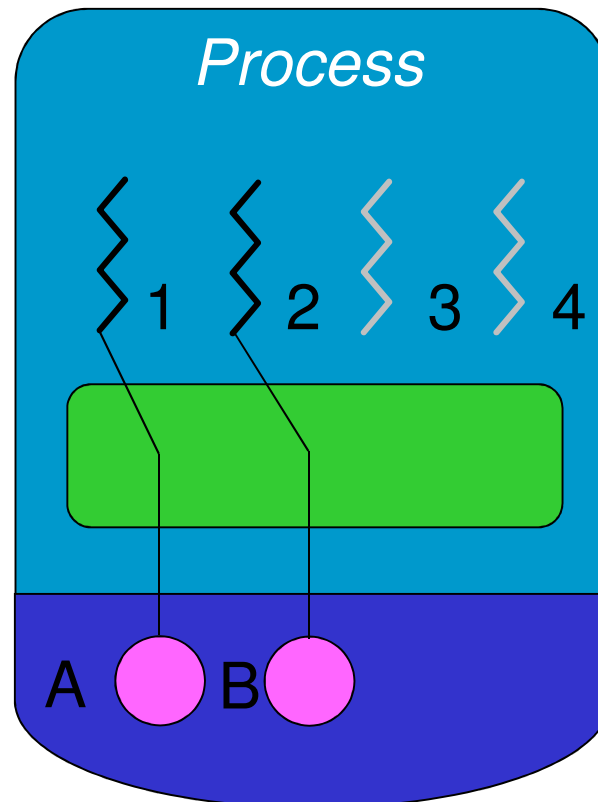

# Working principle

- Blocking syscall scenario on 2 processors

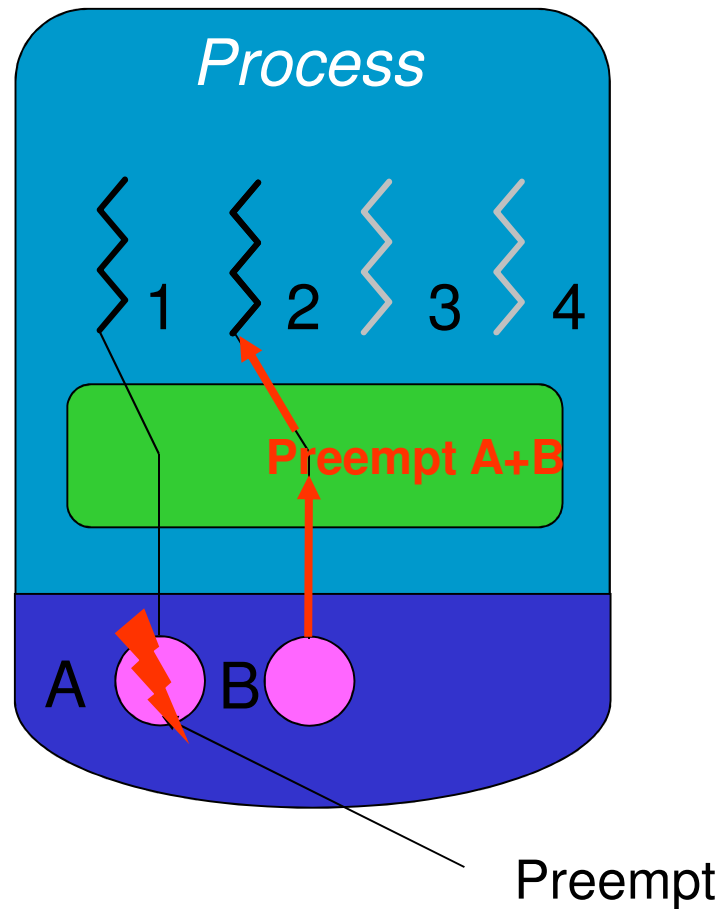

# Working principle

- Blocking syscall scenario on 2 processors

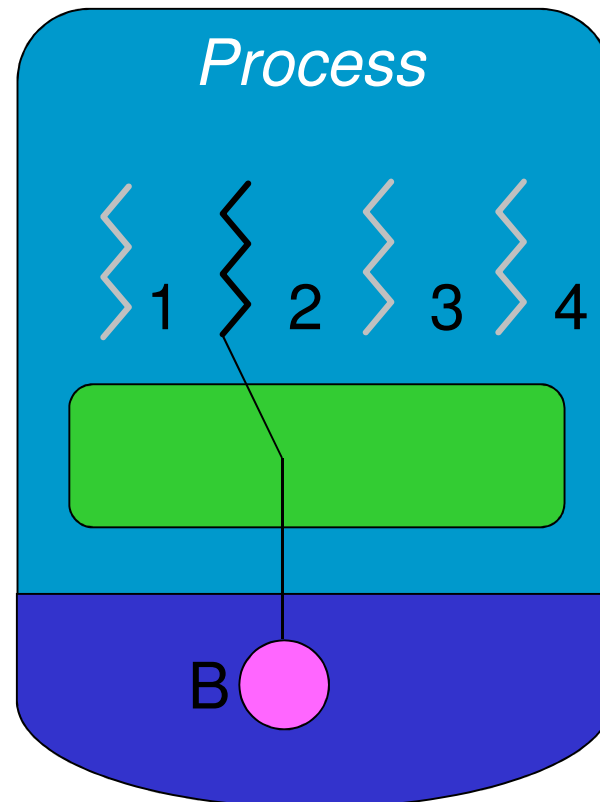

# Working principle

- Blocking syscall scenario on 2 processors

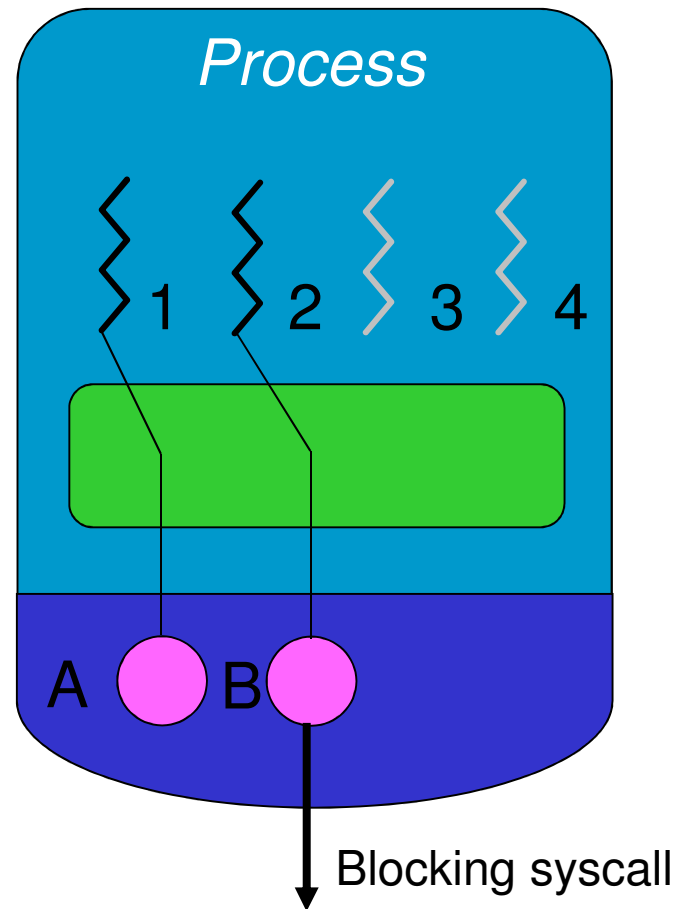

# Working principle

- Blocking syscall scenario on 2 processors

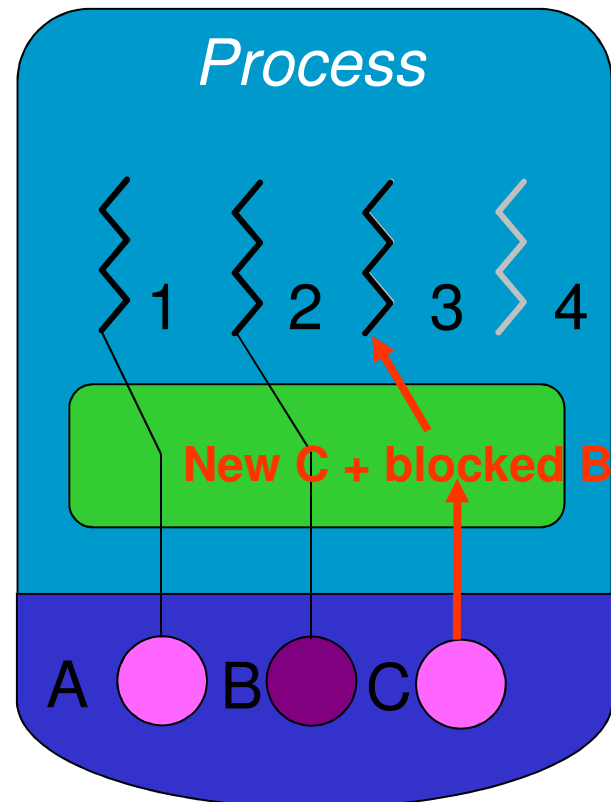



# Working principle

- Blocking syscall scenario on 2 processors

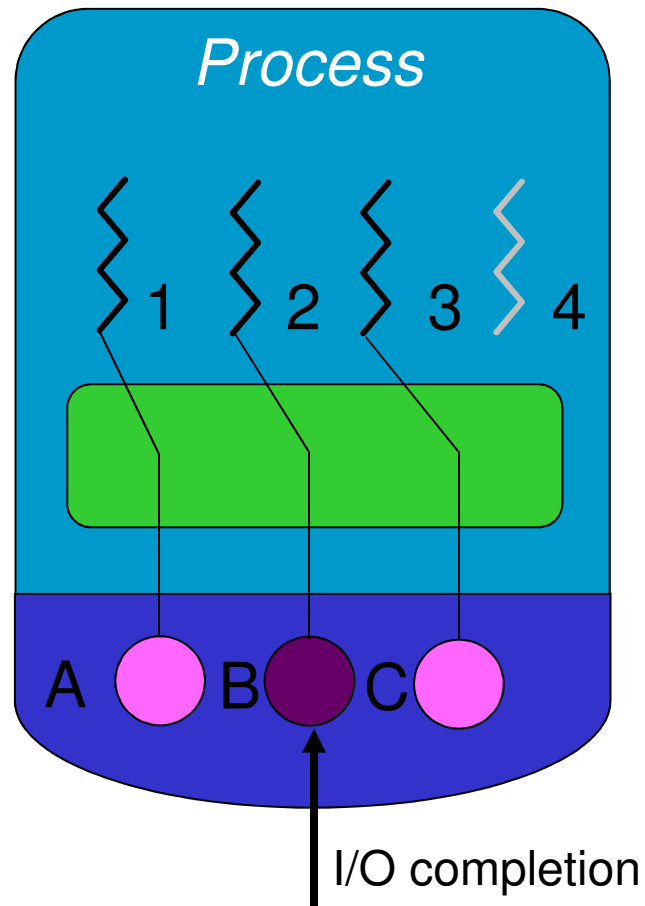

# Working principle

- Blocking syscall scenario on 2 processors

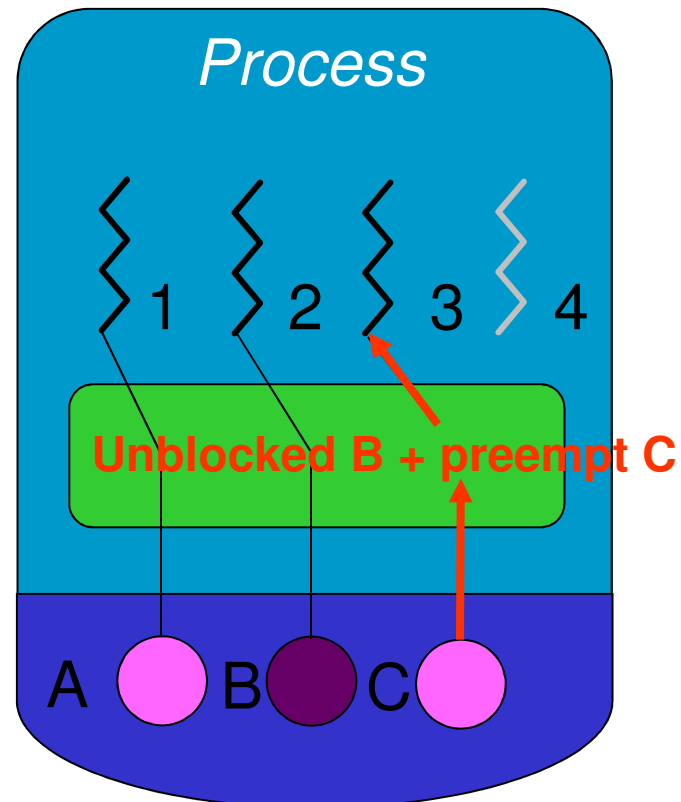

# Working principle

- Blocking syscall scenario on 2 processors

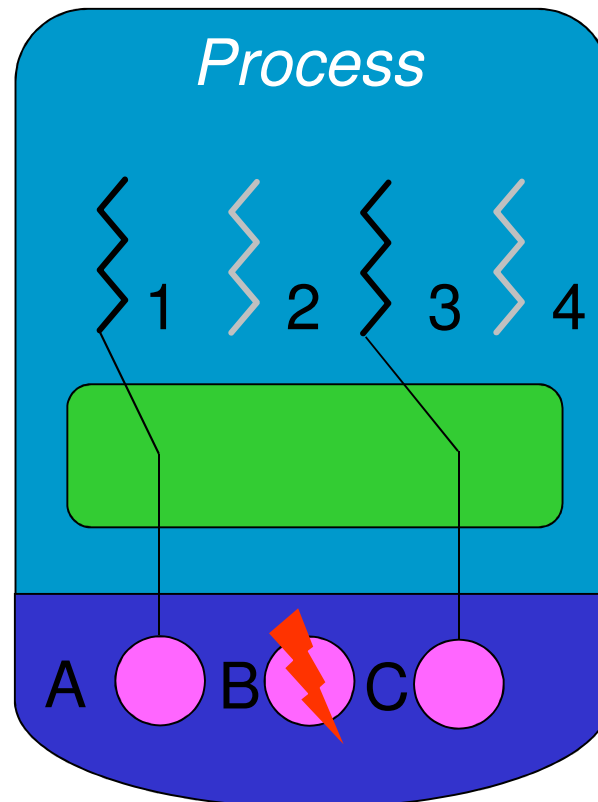

# Scheduler Activations

- Thread management at user-level
  - Fast
- Real thread parallelism via activations
  - Number of activations (virtual CPUs) can equal CPUs
- Blocking (syscall or page fault) creates new activation
  - User-level scheduler can pick new runnable thread.
- Fewer stacks in kernel
  - Blocked activations + number of virtual CPUs



# Performance

Table IV. Thread Operation Latencies ( $\mu\text{sec.}$ )

Operation	FastThreads on Topaz Threads	FastThreads on Scheduler Activations	Topaz threads	Ultrix processes
Null Fork	34	37	948	11300
Signal-Wait	37	42	441	1840



# Performance (compute-bound)

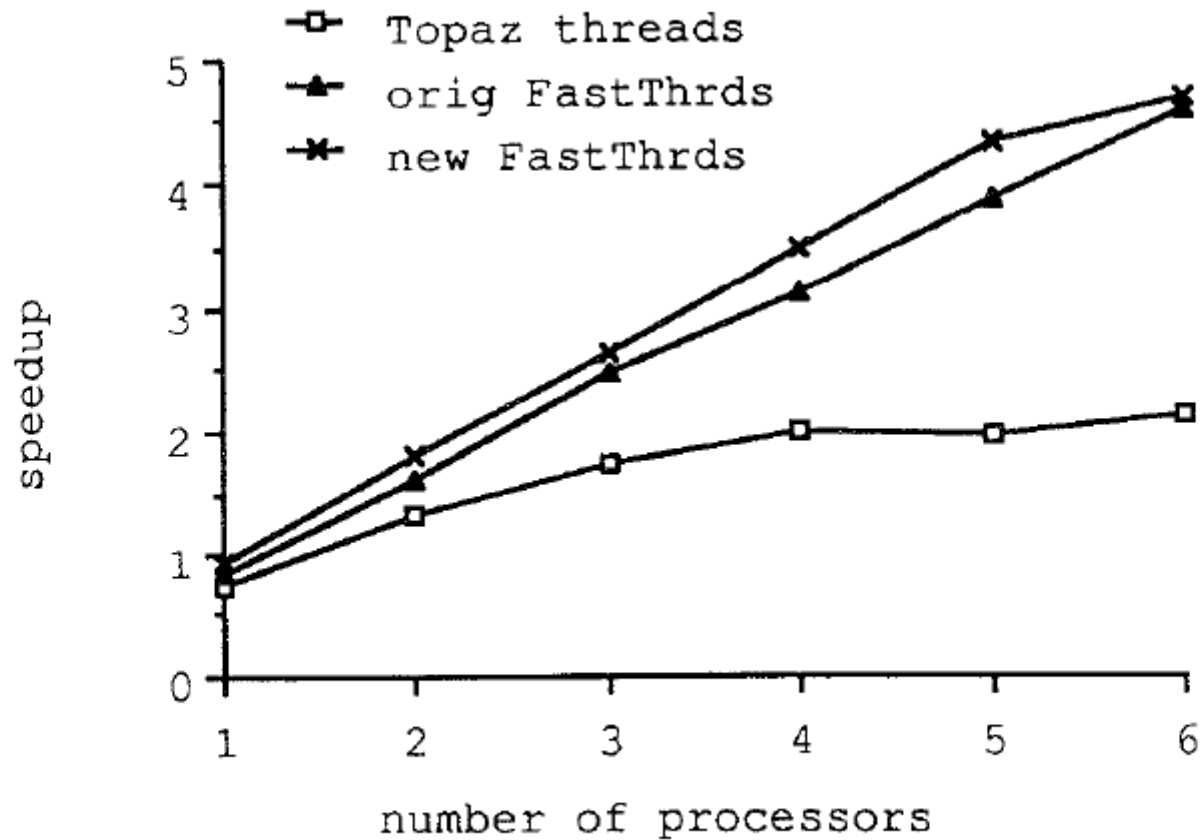

Fig. 2. Speedup of N-Body application versus number of processors, 100% of memory available.



# Performance (I/O Bound)

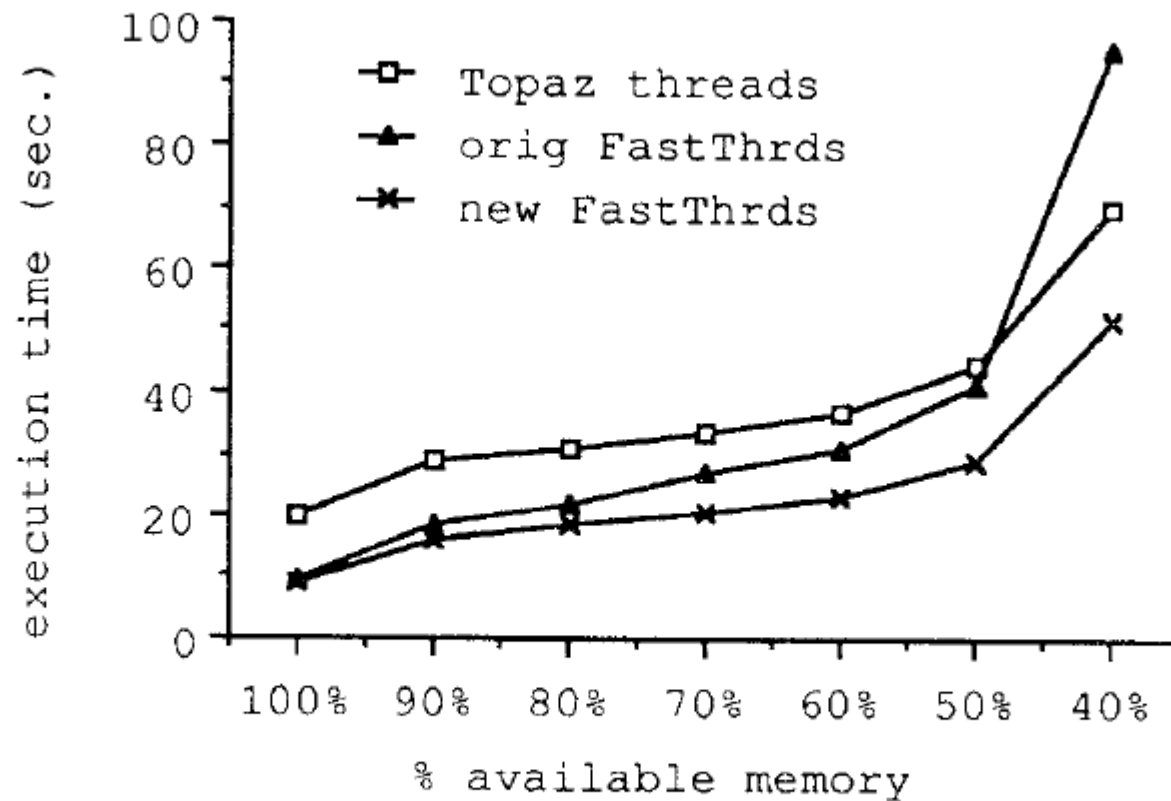

Fig. 3. Execution time of N-Body application versus amount of available memory, 6 processors.

# Adoption

- Adopters
  - BSD “Kernel Scheduled Entities”
    - Reverted back to kernel threads
  - Variants in Research OSs: K42, Barrelfish
  - Digital UNIX
  - Solaris
  - Mach
  - Windows 7 64-bit *User Mode Scheduling*
- Linux, MacOS(?) -> kernel threads





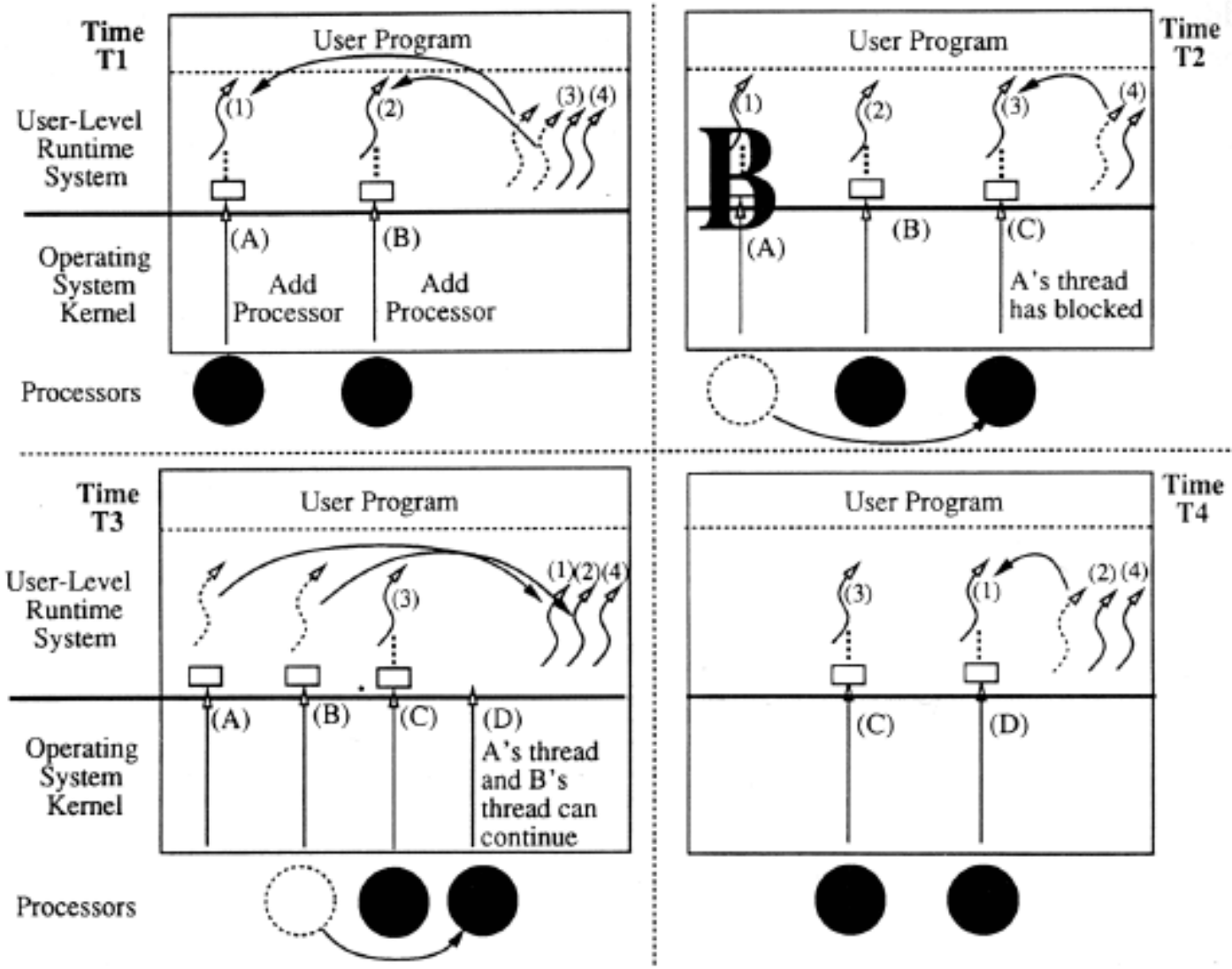

Fig. 1. Example: I/O request/completion.