

cse

## Introduction

COMP3231/9201/3891/9283  
(Extended) Operating Systems  
Kevin Elphinstone



cse

## Course Outline

- Prerequisites
  - COMP2011 Data Organisation
    - Stacks, queues, hash tables, lists, trees, heaps,....
  - COMP2121 Microprocessor and Interfacing
    - Assembly programming
    - Mapping of high-level procedural language to assembly language
  - or the postgraduate equivalent
  - **You are expected to be competent programmers!!!!**
    - We will be using the C programming language
      - The dominant language for OS implementation.
      - Need to understand pointers, pointer arithmetic, explicit memory allocation.



2

cse

## Why does this fail?

```

void func(int *x, int *y)
{
    *x = 1; *y = 2;
}

void main()
{
    int *a, *b;
    func(a, b);
}

```



3

cse

## Lectures

- Common for all courses (3231/3891/9201/9283)
- Wednesday, 2-4pm
- Thursday, 5-6pm
  - All lectures are here (EE LG03)
  - The lecture notes will be available on the course web site
    - Available prior to lectures, when possible.
    - Slide numbers for note taking
  - The lecture notes and textbook are NOT a substitute for attending lectures.



4

cse

## Tutorials

- Start in week 2
- A tutorial participation mark will contribute to your final assessment.
  - Participation means participation, NOT attendance.
  - Comp3891/9283 students excluded
  - Comp9201 optional
- **You will only get participation marks in your enrolled tutorial.**



5

cse

## Assignments

- Assignments form a substantial component of your assessment.
- They are challenging!!!!
  - Because operating systems are challenging
- We will be using OS/161,
  - an educational operating system
  - developed by the [Systems Group At Harvard](#)
  - It contains roughly 20,000 lines of code and comments



6

cse

## Assignments

- Don't underestimate the time needed to do the assignments.
  - ProfQuotes: [About the midterm] "We can't keep you working on it all night, it's not OS." Ragde, CS341
- If you start a couple days before they are due, you will be late.
- To encourage you to start early,
  - Bonus 10% of max mark of the assignment for finishing a week early
  - To iron out any potential problems with the spec, 5% bonus for finishing within 48 hours of assignment release.
  - See course handout for exact details
    - Read the fine print!!!!

 7

cse

## Assignments

- Assignments are in pairs
  - Info on how to pair up available soon
- We usually offer advanced versions of the assignments
  - Available bonus marks are small compared to amount of effort required.
  - Student should do it for the challenge, not the marks.
  - Attempting the advanced component is not a valid excuse for failure to complete the normal component of the assignment
- Extended OS students (COMP3891/9283) are expected to attempt the advanced assignments

 8

cse

## Assignments

- Four assignments
  - due roughly week 4,5, 9,13
- The first one is trivial
  - It's a warm up to have you familiarize yourself with the environment and easy marks.
  - Do not use it as a gauge for judging the difficulty of the following assignments.

 9

cse

## Assignments

- Late penalty
  - 4% of total assignment value per day
    - Assignment is worth 20%
    - You get 18, and are 2 days late
    - Final mark =  $18 - (20 * 0.04 * 2) = 16$  (16.4)
- Assignments are only accepted up to one week late. 8+ days = 0

 10

cse

## Assignments

- To help you with the assignments
  - We dedicate a tutorial per-assignment to discuss issues related to the assignment
  - Prepare for them!!!!

 11

cse

## Plagiarism

- We take cheating seriously!!!
- Penalties include
  - Copying of code: 0 FL
  - Help with coding: negative half the assignment's max marks
  - Originator of a plagiarised solution: 0 for the particular assignment
  - Team work outside group: 0 for the particular assignments

 12

cse

## Cheating Statistics

Session	1998/S1	1999/S1	2000/S1	2001/S1	2001/S2	2002/S1	2002/S2	2003/S1	2003/S2
enrolment	178	410	320	300	107	298	156	333	133
suspected cheaters	10(6%)	26(6%)	22(7%)	26(9%)	20(19%)	15(5%)	???(?)	13 (4%)	???(?)
full penalties	2	6	9	14	10	9	5	2	1
reduced penalties	7	15	7	7	5	4	2	2	9
cheaters failed	4	10	16	16	10	12	5	4	?
cheaters suspended	0	0	1	0	0	1	0	0	0

\*Note: Full penalty 0 FL not applied prior to 2001/S1

THE UNIVERSITY OF NEW SOUTH WALES

13

- cse
- ## Exams
- There is NO mid-session
  - The final written exam is 2 hours
  - Supplementary exams are **oral**.
    - Supplementaries are available according to school policy, not as a second chance.
- THE UNIVERSITY OF NEW SOUTH WALES
- 14

- cse
- ## Assessment
- Exam Mark Component
    - Max mark of 100
  - Based solely on the final exam
  - Class Mark Component
    - Max mark of 100
  - 10% tutorial participation
  - 90% Assignments
- THE UNIVERSITY OF NEW SOUTH WALES
- 15

- cse
- ## 3891/9283
- No tutorial participation component
  - Assignment marks scaled to 100
- THE UNIVERSITY OF NEW SOUTH WALES
- 16

- cse
- ## 9201
- Optional tutorial participation, we'll award the better mark of
    - Tutorial participation included as for comp3231
    - Class marked based solely on the assignments
- THE UNIVERSITY OF NEW SOUTH WALES
- 17

- cse
- ## Undergrad Assessment
- The final assessment is the harmonic mean of the exam and class component.
  - If  $E \geq 40$ ,
- $$M = \frac{2EC}{E + C}$$
- THE UNIVERSITY OF NEW SOUTH WALES
- 18

cse

## Postgrads (9201/9283)

- Maximum of a 50/50 weighted harmonic mean and a 20/80 harmonic mean
  - Can weight final mark heavily on exam if you can't commit the time to the assignments
  - You are rewarded for seriously attempting the assignments
- if  $E \geq 40$ ,

$$M = \max\left(\frac{2EC}{E+C}, \frac{5EC}{E+4C}\right)$$

THE UNIVERSITY OF NEW SOUTH WALES 19

cse

## Assessment

- If  $E < 40$

$$M = \min\left(44, \frac{2EC}{E+C}\right)$$

THE UNIVERSITY OF NEW SOUTH WALES 20

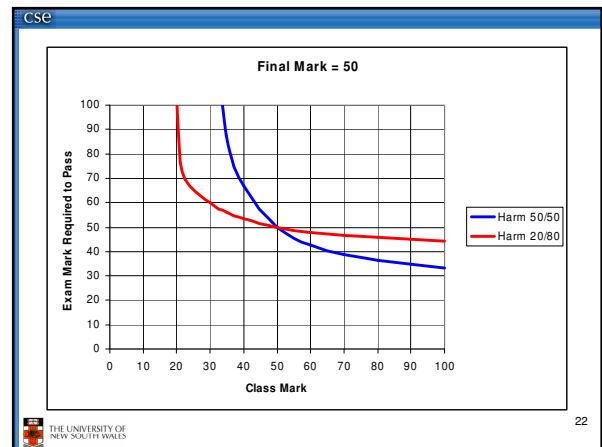
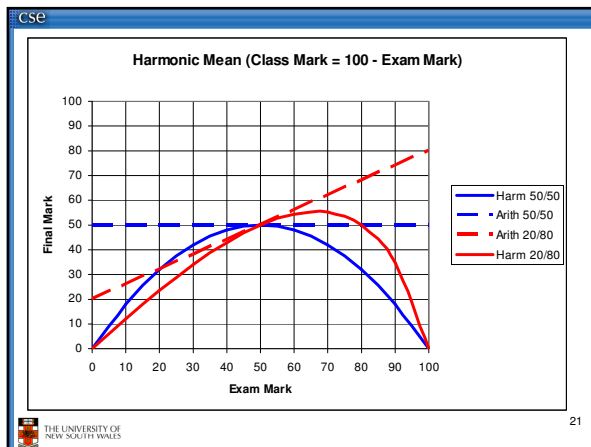

cse

## Assessment

- You need to perform reasonably consistently in both exam and class components.
- Harmonic mean only has significant effect with significant variation.
- Reserve the right to scale, and scale courses individually if required.
  - Warning: We have not scaled in the past.

THE UNIVERSITY OF NEW SOUTH WALES 26

cse

## Textbook

- Andrew Tanenbaum, *Modern Operating Systems*, 2<sup>nd</sup> Edition, Prentice Hall

THE UNIVERSITY OF NEW SOUTH WALES 27

cse

## References

- A. Silberschatz and P.B. Galvin, *Operating System Concepts*, 5<sup>th</sup>, 6<sup>th</sup>, or 7<sup>th</sup> edition, Addison Wesley
- William Stallings, *Operating Systems: Internals and Design Principles*, 4th or 5<sup>th</sup> edition, Prentice Hall.
- A. Tannenbaum, A. Woodhull, *Operating Systems--Design and Implementation*, 2<sup>nd</sup> edition Prentice Hall
- John O'Gorman, *Operating Systems*, MacMillan, 2000
- Uresh Vahalla, *UNIX Internals: The New Frontiers*, Prentice Hall, 1996
- McKusick et al., *The Design and Implementation of the 4.4 BSD Operating System*, Addison Wesley, 1996

THE UNIVERSITY OF NEW SOUTH WALES 28

cse

## Consultations/Questions

- Questions should be directed to the forum.
- Admin related queries to Nicholas Fitzroy-Dale [nfd@cse.unsw.edu.au](mailto:nfd@cse.unsw.edu.au)
- Personal queries can be directed to me [kevine@cse.unsw.edu.au](mailto:kevine@cse.unsw.edu.au)
- We reserve the right to ignore email sent directly to us (including tutors) if it should have been directed to the forum.
- Consultation Times
  - TBA

THE UNIVERSITY OF NEW SOUTH WALES 29

cse

## Course Outline

- Processes and threads
- Concurrency control
- Memory Management
- File Systems
- I/O and Devices
- Security
- Scheduling

THE UNIVERSITY OF NEW SOUTH WALES 30

cse

## Introduction to Operating Systems

Chapter 1 – 1.3

THE UNIVERSITY OF NEW SOUTH WALES

cse

## Learning Outcomes

- High-level understand what is an operating system and the role it plays
- Appreciate the evolution of operating systems tracks the evolution of hardware, and that evolution is repeated in each new hardware era.
- 

THE UNIVERSITY OF NEW SOUTH WALES 32

cse

## What is an Operating System?

THE UNIVERSITY OF NEW SOUTH WALES 33

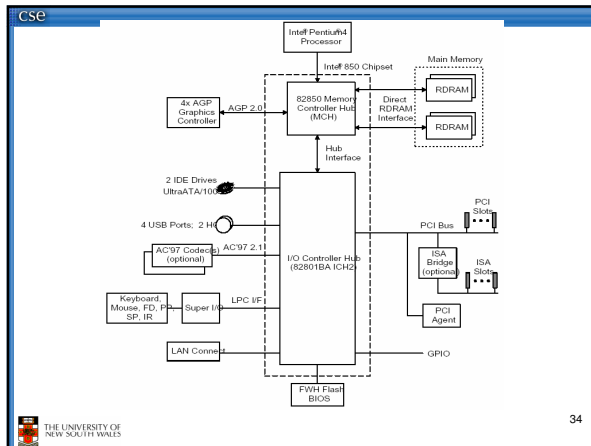

## Viewing the Operating System as an Abstract Machine

- Extends the basic hardware with added functionality
- Provides high-level abstractions
  - More programmer friendly
  - Common core for all applications
- It hides the details of the hardware
  - Makes application code portable

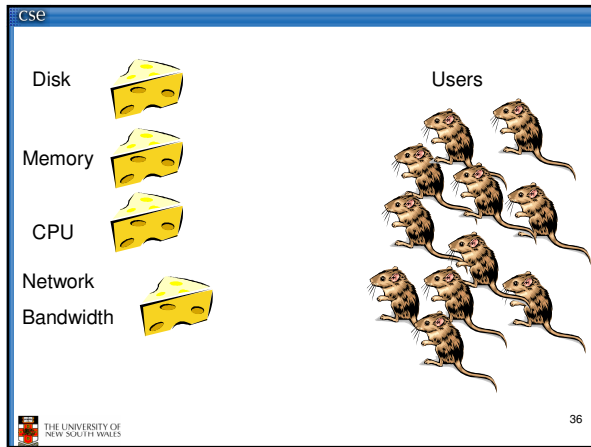

## Viewing the Operating System as a Resource Manager

- Responsible for allocating resources to users and processes
- Must ensure
  - No Starvation
  - Progress
  - Allocation is according to some desired policy
    - First-come, first-served; Fair share; Weighted fair share; limits (quotas), etc...
  - Overall, that the system is efficiently used

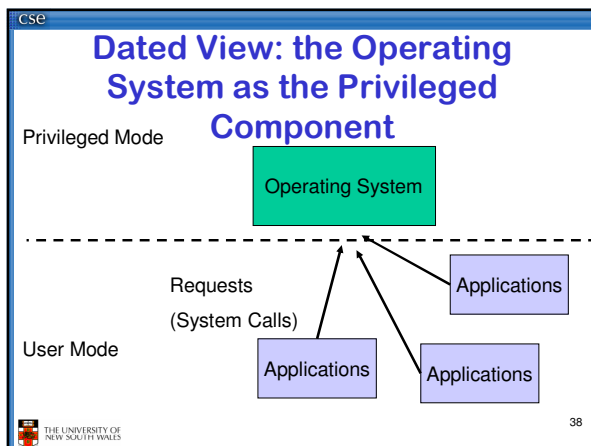

## The Operating System is Privileged

- Applications should not be able to interfere or bypass the operating system
  - OS can enforce the "extended machine"
  - OS can enforce its resource allocation policies
  - Prevent applications from interfering with each other
- Note: Some Embedded OSs have no privileged component, e.g. PalmOS
  - Can implement OS functionality, but cannot enforce it.
- Note: Some operating systems implement significant OS functionality in user-mode, e.g. User-mode Linux

cse

## Why Study Operating Systems?

- There are many interesting problems in operating systems.
- For a complete, top-to-bottom view of a system.
- Understand performance implications of application behaviour.
- Understanding and programming large, complex, software systems is a good skill to acquire.

THE UNIVERSITY OF NEW SOUTH WALES 40

cse

## (A brief) Operating System History

- Largely parallels hardware development
- First Generation machines
  - Vacuum tubes
  - Plug boards
    - Programming via wiring
    - Users were simultaneously designers, engineers, and programmers
    - “single user”
    - difficult to debug (hardware)
  - No Operating System

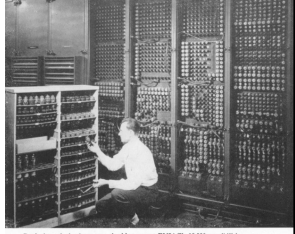

Replacing a hot tube mount checking among ENIAC's 19,600 possibilities.

THE UNIVERSITY OF NEW SOUTH WALES 41

cse

## Second Generation Machines Batch Systems

- IBM 7094
  - 0.35 MIPS, 32K x 36-bit memory
  - 3.5 million dollars
- Batching used to more efficiently use the hardware
  - Share machine amongst many users
  - One at a time
  - Debugging a pain
    - Drink coffee until jobs finished



THE UNIVERSITY OF NEW SOUTH WALES 42

cse

## Batch System Operating Systems

- Sometimes called “resident job monitor”
- Managed the Hardware
- Simple Job Control Language (JCL)
  - Load compiler
  - Compile job
  - Run job
  - End job
- No resource allocation issues
  - “one user”

THE UNIVERSITY OF NEW SOUTH WALES 43

cse

## Problem: Keeping Batch Systems Busy

- Reading tapes or punch cards was time consuming
- Expensive CPU was idle waiting for input

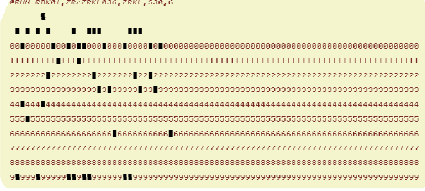

THE UNIVERSITY OF NEW SOUTH WALES 44

cse

## Third Generation Systems - Multiprogramming

- Divided memory among several loaded jobs
- While one job is loading, CPU works on another
- With enough jobs, CPU 100% busy
- Needs special hardware to isolate memory partitions from each other
  - This hardware was notably absent on early 2<sup>nd</sup> gen. batch systems



Memory

THE UNIVERSITY OF NEW SOUTH WALES 45

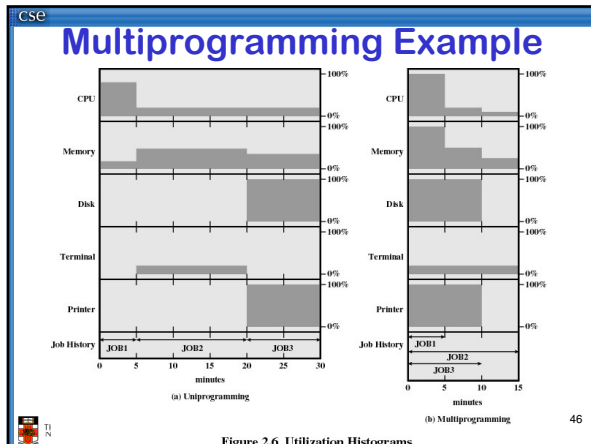

### Job turn-around time was still an issue.

- Batch systems were well suited to
  - Scientific calculations
  - Data processing
- For programmers, debugging was much easier on older first gen. machines as the programmer had the machine to himself.
- Word processing on a batch system?

### Time sharing

- Each user had his/her own terminal connected to the machine
- All user's jobs were multiprogrammed
  - Regularly switch between each job
  - Do it fast
- Gives the illusion that the programmer has the machine to himself
- Early examples: Compatible Time Sharing System (CTSS), MULTICS

### An then...

- Further developments (hardware and software) resulted in improved techniques, concepts, and operating systems.....
  - CAP, Hydra, Mach, UNIX V6, BSD UNIX, THE, Thoth, Sprite, Accent, UNIX SysV, Linux, EROS, KeyKOS, OS/360, VMS, HPUX, Apollo Domain, Nemesis, L3, L4, CP/M, DOS, Exo-kernel, Angel, Mungi, BE OS, Cache Kernel, Choices, V, Inferno, Grasshopper, MOSIX, Opal, SPIN, VINO, OS9, Plan/9, QNX, Synthetix, Tornado, x-kernel, VxWorks, Solaris.....

### The Advent of the PC

- Large Scale Integration (LSI) made small, fast(-ish), cheap computers possible
- OSs followed a similar path as with the mainframes
  - Simple "single-user" systems (DOS)
  - Multiprogramming without protection, (80286 era, Window 3.1, 95, 98, ME, etc..., MacOS <= 9)
  - "Real" operating systems (UNIX, WinNT, MacOS X etc..)

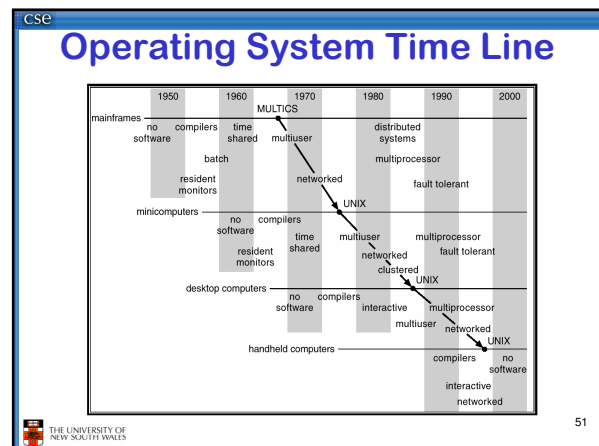



cse

# Computer Hardware Review

## Chapter 1.4

THE UNIVERSITY OF NEW SOUTH WALES

cse

## Learning Outcomes

- Understand the basic components of computer hardware
  - CPU, buses, memory, devices controllers, DMA, Interrupts, hard disks
- Understand the concepts of memory hierarchy and caching, and how they affect performance.

53

cse

## Operating Systems

- Exploit the hardware available
- Provide a set of high-level services that represent or are implemented by the hardware.
- Manages the hardware reliably and efficiently
- *Understanding operating systems requires a basic understanding of the underlying hardware*

54

cse

## Basic Computer Elements

The diagram illustrates the basic computer elements connected to a central system bus. On the left, a CPU is connected to the bus. Above the bus, there are two disk drives connected to a disk controller, a printer connected to a printer controller, and two tape drives connected to a tape-drive controller. Below the bus, a memory controller is connected to the bus, which in turn is connected to memory.

55

cse

## Basic Computer Elements

- CPU
  - Performs computations
  - Load data to/from memory via system bus
- Device controllers
  - Control operation of their particular device
  - Operate in parallel with CPU
  - Can also load/store to memory (Direct Memory Access, DMA)
  - Control register appear as memory locations to CPU
    - Or I/O ports
  - Signal the CPU with “interrupts”
- Memory Controller
  - Responsible for refreshing dynamic RAM
  - Arbitrating access between different devices and CPU

56

cse

## The real world is logically similar, but a little more complex

This diagram shows a more complex system architecture. At the top is the Intel Pentium 4 Processor, connected to the Intel 850 Chipset. The chipset includes the 82850 Memory Controller Hub (MCH) and the I/O Controller Hub (ICH2). The MCH is connected to Main Memory (EDRAM and DDRAM) via a Direct Rambus Interface. The ICH2 is connected to various peripheral devices: 4x AGP Original Controller (AGP 2.0), 2 IDE Drives (UltraATA100), 4 USB Ports (2 H), AC'97 Coded (optional) and AC'97 2.1, Keyboard Mouse, ED, SP, IR, Super I, LPT, and LAN Controller. The ICH2 also connects to the PCI Bus, which includes PCI Slots, ISA Bridge (optional), ISA Slots (optional), and PCI Agent. The system is powered by FWH Flat BIOS and includes GPIO.

57

cse

## A Simple Model of CPU Computation

- The fetch-execute cycle

```

    graph LR
      START([START]) --> Fetch[Fetch Next Instruction]
      Fetch --> Execute[Execute Instruction]
      Execute --> HALT([HALT])
      Fetch -.-> Fetch
      Execute -.-> Execute
  
```

Figure 1.2 Basic Instruction Cycle

THE UNIVERSITY OF NEW SOUTH WALES 58

cse

## A Simple Model of CPU Computation

- Stack Pointer
- Status Register
  - Condition codes
    - Positive result
    - Zero result
    - Negative result
- General Purpose Registers
  - Holds operands of most instructions
  - Enables programmers to minimise memory references.

CPU Registers

PC: 0x0300
SP: 0xcbf3
Status
R1
↑
Rn

THE UNIVERSITY OF NEW SOUTH WALES 59

cse

## A Simple Model of CPU Computation

- The fetch-execute cycle
  - Load memory contents from address in program counter (PC)
    - The instruction
  - Execute the instruction
  - Increment PC
  - Repeat

CPU Registers

PC: 0x0300
SP: 0xcbf3
Status
R1
↑
Rn

THE UNIVERSITY OF NEW SOUTH WALES 60

cse

## Privileged-mode Operation

- To protect operating system execution, two or more CPU modes of operation exist
  - Privileged mode (system-, kernel-mode)
    - All instructions and registers are available
  - User-mode
    - Uses 'safe' subset of the instruction set
      - E.g. no disable interrupts instruction
    - Only 'safe' registers are accessible

CPU Registers

Interrupt Mask
Exception Type
MMU regs
Others
PC: 0x0300
SP: 0xcbf3
Status
R1
↑
Rn

THE UNIVERSITY OF NEW SOUTH WALES 61

cse

## 'Safe' registers and instructions

- Registers and instructions are safe if
  - Only affect the state of the application itself
  - They cannot be used to uncontrollably interfere with
    - The operating system
    - Other applications
  - They cannot be used to violate a correctly implemented operating system policy.

THE UNIVERSITY OF NEW SOUTH WALES 62

cse

## Privileged-mode Operation

Address Space

- The accessibility of 0xFFFFFFFF addresses within an address space changes depending on operating mode
  - To protect kernel code and data

Accessible only to Kernel-mode
Accessible to User- and Kernel-mode

0x00000000

THE UNIVERSITY OF NEW SOUTH WALES 63

cse

## I/O and Interrupts

- I/O events (keyboard, mouse, incoming network packets) happen at unpredictable times
- How does the CPU know when to service an I/O event?

THE UNIVERSITY OF NEW SOUTH WALES 64

cse

## Interrupts

- An interruption of the normal sequence of execution
- A suspension of processing caused by an event external to that processing, and performed in such a way that the processing can be resumed.
- Improves processing efficiency
  - Allows the processor to execute other instructions while an I/O operation is in progress
  - Avoids unnecessary completion checking (polling)

THE UNIVERSITY OF NEW SOUTH WALES 65

cse

## Interrupt Cycle

- Processor checks for interrupts
- If no interrupts, fetch the next instruction
- If an interrupt is pending, divert to the interrupt handler

Figure 1.7 Instruction Cycle with Interrupts

THE UNIVERSITY OF NEW SOUTH WALES 66

cse

## Classes of Interrupts

- Program exceptions (also called *synchronous interrupts*)
  - Arithmetic overflow
  - Division by zero
  - Executing an illegal/privileged instruction
  - Reference outside user's memory space.
- Asynchronous (external) events
  - Timer
  - I/O
  - Hardware or power failure

THE UNIVERSITY OF NEW SOUTH WALES 67

cse

## Interrupt Handler

- A program that determines the nature of the interrupt and performs whatever actions are needed.
- Control is transferred to the handler by *hardware*.
- The handler is generally part of the operating system.

THE UNIVERSITY OF NEW SOUTH WALES 68

cse

## Simple Interrupt

THE UNIVERSITY OF NEW SOUTH WALES 69

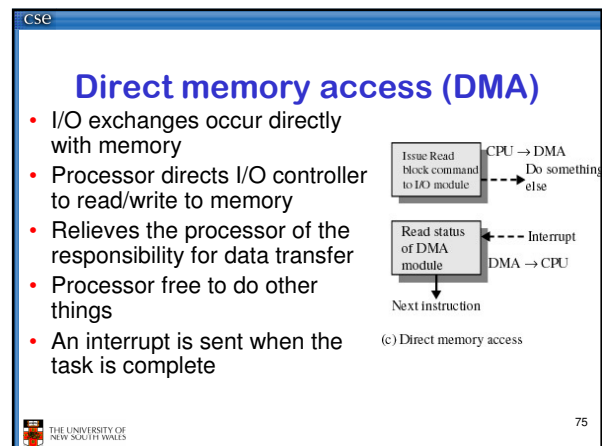
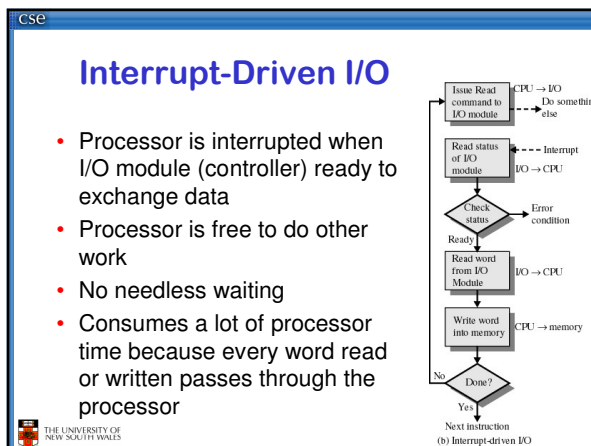
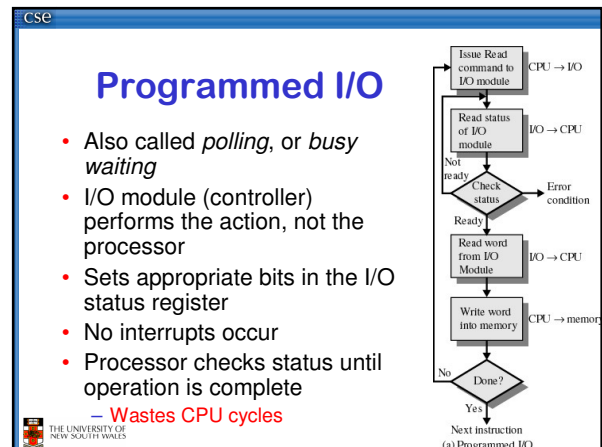
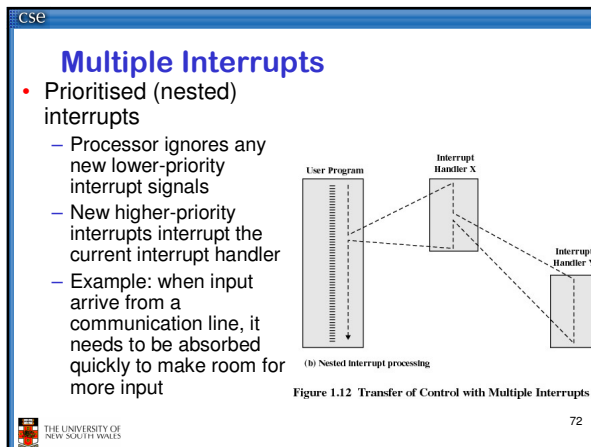
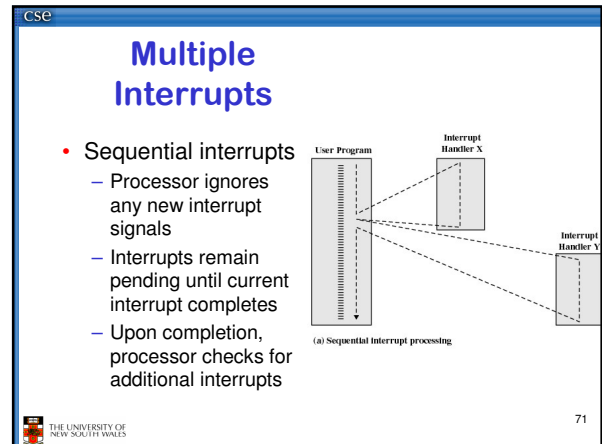
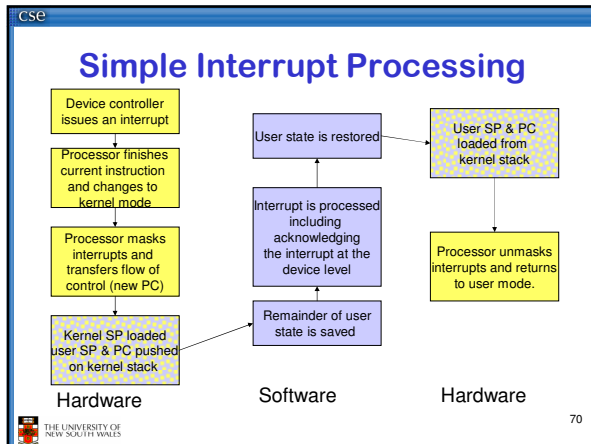

**Multiprogramming (Multitasking)**

- Processor has more than one program to execute.
  - Some tasks waiting for I/O to complete
  - Some tasks ready to run, but not running
- Interrupt handler can switch to other tasks when they become runnable
- Regular timer interrupts can be used for timesharing

76

**Memory Hierarchy**

- Going down the hierarchy
  - Decreasing cost per bit
  - Increasing capacity
  - Increasing access time
  - Decreasing frequency of access to the memory by the processor
    - Hopefully
    - Principle of locality!!!!

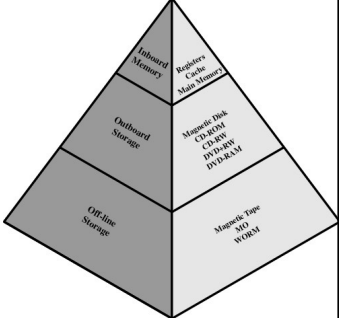

Figure 1.14. The Memory Hierarchy

**Memory Hierarchy**

- Rough approximation of memory hierarchy

Typical access time		Typical capacity
1 nsec	Registers	<1 KB
2 nsec	Cache	1 MB
10 nsec	Main memory	64-512 MB
10 msec	Magnetic disk	5-50 GB
100 sec	Magnetic tape	20-100 GB

78

**Cache**

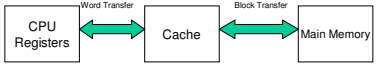

- Cache is fast memory placed between the CPU and main memory
  - 1 to a few cycles access time compared to RAM access time of tens – hundreds of cycles
- Holds recently used data or instructions to save memory accesses.
- Matches slow RAM access time to CPU speed if high hit rate
- Is hardware maintained and (mostly) transparent to software
- Sizes range from few kB to several MB.
- Usually a hierarchy of caches (2–5 levels), on- and off-chip.
- Block transfers can achieve higher transfer bandwidth than single words.
  - Also assumes probability of using newly fetch data is higher than the probability of reuse ejected data.

79

**Processor-DRAM Gap (latency)**

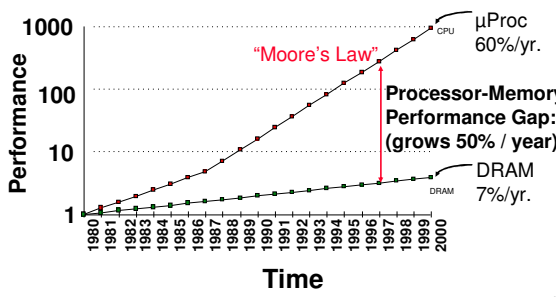

80

**Cache size affect on performance**

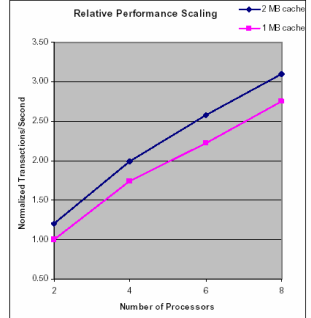
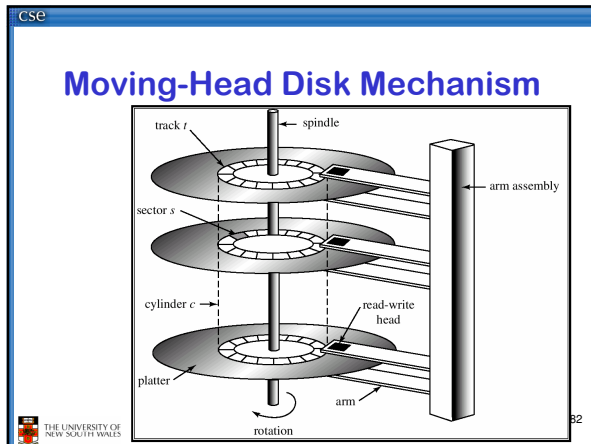

Figure 1. OLTP Performance Improvement Between 1-MB and 2-MB Caches in a ProLiant 8500 Server

81



- cse
- ## Example Disk Access Times
- Disk can read/write data relatively fast
    - 15,000 rpm drive - 80 MB/sec
    - 1 KB block is read in 12 microseconds
  - Access time dominated by time to locate the head over data
    - Rotational latency
      - Half one rotation is 2 milliseconds
    - Seek time
      - Full inside to outside is 8 milliseconds
      - Track to track .5 milliseconds
  - 2 milliseconds is 164KB in "lost bandwidth"
- THE UNIVERSITY OF NEW SOUTH WALES 83

- cse
- ## A Strategy: Avoid Waiting for Disk Access
- Keep a subset of the disk's data in memory
- ⇒ Main memory acts as a *cache* of disk contents
- THE UNIVERSITY OF NEW SOUTH WALES 84

- cse
- ## Two-level Memories and Hit Rates
- Given a two-level memory,
    - cache memory and main memory (RAM)
    - main memory and disk
- what is the effective access time?
- Answer: It depends on the hit rate in the first level.
- THE UNIVERSITY OF NEW SOUTH WALES 85

cse

## Effective Access Time

$$T_{eff} = H \times T_1 + (1 - H) \times (T_1 + T_2)$$

$T_1$  = access time of memory 1  
 $T_2$  = access time of memory 2  
 $H$  = hit rate in memory 1  
 $T_{eff}$  = effective access time of system

THE UNIVERSITY OF NEW SOUTH WALES 86

cse

## Example

- Cache memory access time 1ns
- Main memory access time 10ns
- Hit rate of 95%

$$T_{eff} = 0.95 \times 1 \times 10^{-9} + 0.05 \times (1 \times 10^{-9} + 10 \times 10^{-9}) = 1.5 \times 10^{-9}$$

THE UNIVERSITY OF NEW SOUTH WALES 87