

# **IDT R30xx Family Software Reference Manual**

**Revision 1.0**

©1994 Integrated Device Technology, Inc.

Portions ©1994 Algorithmics, Ltd.

Chapter 16 contains some material that is ©1988 Prentice-Hall.

Appendices A & B contain material that is ©1994 by Mips Technology, Inc.

---

## **About IDT**

---

Integrated Device Technology, Inc. has been a MIPS semiconductor partner since 1988, and has led efforts to bring the high-performance inherent in the MIPS architecture to embedded systems engineers. These efforts include derivatives of MIPS R3xxx and R4xxx CPUs, development tools, and applications support.

Additional information about IDT's RISC family can be obtained from your local sales representative. Alternately, IDT can be reached directly at:

<i>Corporate Marketing</i>	<i>(800) 345-7015</i>
<i>RISC Applications "Hotline"</i>	<i>(408) 492-8208</i>
<i>RISC Applications FAX</i>	<i>(408) 492-8469</i>
<i>RISC Applications Internet</i>	<i>rischelp@idtinc.com</i>

---

## **About Algorithmics**

---

Much of this manual was written by Dominic Sweetman and Nigel Stephens of Algorithmics Ltd in London, England, under contract to IDT. Algorithmics were early enthusiasts for the MIPS architecture, designing their first MIPS systems and system software in 1986/87. A small engineering company, Algorithmics provide enabling technologies for companies designing in both R30xx family CPUs and the 64-bit R4x00 architecture. This includes training, toolkits, GNU C support, and evaluation boards. Dominic Sweetman can be reached at the following:.

Dominic Sweetman	phone: +44 71 700 3301
Algorithmics Ltd	fax: +44 71 700 3400
3 Drayton Park	email: dom@algor.co.uk
London N5 1NU	
ENGLAND.	

## ***About This Manual***

---

This manual is targeted to a systems programmer building an R30xx-based system. It contains the architecture specific operations and programming conventions relevant to such a programmer.

This manual is not intended to be a tutorial on structured programming, real-time operating systems, any particular high-level programming language, or any particular toolchain. Other references are better suited to those topics.

This manual does contain specific code fragments and the most common programming conventions that are specific to the IDT R30xx RISC controller family. The manual was consciously limited to the R30xx family; information relevant to the R4xxx family of processors may be found, but the device specific programs (such as cache management, exception handling, etc.) shown as examples are specific to the R30xx family.

This manual contains references to the toolchains most commonly used by the authors (IDT, Inc., and Algorithmics, Ltd.). Code fragments shown are typically from software used by and/or provided by these companies, including development tools such as IDT/c and software utilities (such as IDT/kit, IDT/sim, and Micromonitor). A wide variety of other, 3rd party products, are also available to support R30xx development, under the Advantage-IDT program. The reader of this manual is encouraged to look at all the available tools to determine which toolchains and utilities best fit the system development requirements.

Additional information on the IDT family of RISC processors, and their support tools, is available from your local IDT salesman.

Integrated Device Technology, Inc. reserves the right to make changes to its products or specifications at any time, without notice, in order to improve design or performance and to supply the best possible product. IDT does not assume any responsibility for use of any circuitry described other than the circuitry embodied in an IDT product. The Company makes no representations that circuitry described herein is free from patent infringement or other rights of third parties which may result from its use. No license is granted by implication or otherwise under any patent, patent rights or other rights, of Integrated Device Technology, Inc.

#### **LIFE SUPPORT POLICY**

**Integrated Device Technology's products are not authorized for use as critical components in life support devices or systems unless a specific written agreement pertaining to such intended use is executed between the manufacturer and an officer of IDT.**

**1. Life support devices or systems are devices or systems which (a) are intended for surgical implant into the body or (b) support or sustain life and whose failure to perform, when properly used in accordance with instructions for use provided in the labeling, can be reasonably expected to result in a significant injury to the user.**

**2. A critical component is any components of a life support device or system whose failure to perform can be reasonably expected to cause the failure of the life support device or system, or to affect its safety or effectiveness.**

The IDT logo is a registered trademark and BiCameral, BurstRAM, BUSMUX, CacheRAM, DECnet, Double-Density, FASTX, Four-Port, FLEXI-CACHE, Flexi-PAK, Flow-thruEDC, IDT/c, IDTenvY, IDT/sae, IDT/sim, IDT/ux, MacStation, MICROSLICE, Orion, PalatteDAC, REAL8, R3041, R3051, R3052, R3081, R3721, R4600, RISCompiler, RISController, RISCORE, RISC Subsystem, RISC Windows, SARAM, SmartLogic, SyncFIFO, SyncBiFIFO, SPC, TargetSystem and WideBus are trademarks of Integrated Device Technology, Inc.

MIPS is a registered trademark of MIPS Computer Systems, Inc

All others are trademarks of their respective companies..

# IDT R30xx Family Software Reference Manual

## Table of Contents

<b>Introduction.....</b>	<b>1</b>
What is a RISC?.....	1-1
PIPELINES .....	1-2
The IDT R3xxx Family CPUs .....	1-3
MIPS Architecture Levels.....	1-4
MIPS-1 Compared with CISC Architectures.....	1-4
Unusual Instruction Encoding Features .....	1-5
Addressing and Memory Accesses .....	1-5
Operations not Directly Supported .....	1-6
Multiply and Divide Operations .....	1-7
Programmer-visible Pipeline Effects .....	1-7
A Note on Machine and Assembler Language .....	1-8
<b>MIPs-1 (R30xx) Architecture.....</b>	<b>2</b>
Programmer’s View of the Processor Architecture.....	2-1
Registers.....	2-1
Conventional Names and Uses of General-Purpose Registers .....	2-2
Notes on Conventional Register Names .....	2-2
Integer Multiply Unit and Registers .....	2-3
Instruction Types .....	2-4
Loading and Storing: Addressing Modes .....	2-5
Data types in Memory and Registers .....	2-6
Integer Data Types .....	2-6
Unaligned Loads and Stores .....	2-6
Floating Point Data in Memory .....	2-7
Basic Address Space.....	2-8
Summary of System Addressing.....	2-9
Kernel vs. User Mode .....	2-9
Memory map for CPUs without MMU Hardware.....	2-10
Subsegments in the R3041 – Memory Width Configuration .....	2-10
<b>System Control Coprocessor Architecture.....</b>	<b>3</b>
CPU Control Summary .....	3-1
CPU Control and “CO-PROCESSOR 0” .....	3-2
CPU Control Instructions.....	3-2
Standard CPU control registers.....	3-3
PRId Register .....	3-4
SR Register .....	3-4
Cause Register .....	3-7
EPC Register .....	3-8
BadVaddr Register .....	3-8
R3041, R3071, and R3081 Specific Registers.....	3-8

---

Count and Compare Registers (R3041 only) .....	3-8
Config Register (R3071 and R3081) .....	3-8
Config Register (R3041) .....	3-9
BusCtrl Register (R3041 only) .....	3-10
PortSize Register (R3041 only) .....	3-11
What registers are relevant when? .....	3-11
<b>Exception Management.....</b>	<b>4</b>
Exceptions .....	4-1
Precise Exceptions .....	4-1
When Exceptions Happen .....	4-2
Exception vectors .....	4-2
Exception Handling – Basics.....	4-3
Nesting Exceptions .....	4-4
An Exception Routine .....	4-4
Interrupts.....	4-12
Conventions and Examples .....	4-14
<b>Cache Management .....</b>	<b>5</b>
Caches and Cache Management .....	5-1
Cache Isolation and Swapping .....	5-3
Initializing and Sizing the Caches .....	5-4
Invalidation.....	5-6
Testing and Probing.....	5-8
Configuration (R3041/71/81 only).....	5-8
Write Buffer.....	5-9
Implementing <i>wbflush()</i> .....	5-10
<b>Memory Management and the TLB .....</b>	<b>6</b>
Memory Management and the TLB .....	6-1
MMU Registers Described .....	6-3
EntryHi, EntryLo .....	6-3
Index .....	6-4
Random .....	6-4
Context .....	6-4
MMU Control Instructions .....	6-5
Programming Interface to the TLB.....	6-5
How Refill Happens .....	6-5
Using ASIDs .....	6-6
The Random Register and Wired Entries .....	6-6
Memory Translation – Setup .....	6-6
TLB Exception Sample Code .....	6-7
Basic Exception Handler .....	6-7
Fast kuseg Refill from Page Table .....	6-7
Simulating Dirty Bits.....	6-8
Use of TLB in Debugging .....	6-8
TLB Management Utilities .....	6-9
<b>Reset Initialization.....</b>	<b>7</b>
Starting Up.....	7-1
Probing and Recognizing the CPU .....	7-4
Bootstrap Sequences .....	7-5
Starting Up an Application .....	7-5

---

---

<b>Floating Point Coprocessor .....</b>	<b>8</b>
The IEEE754 Standard and its Background .....	8-1
What is Floating Point?.....	8-2
IEEE exponent field and bias.....	8-3
IEEE mantissa and normalization.....	8-3
Strange values use reserved exponent values .....	8-3
MIPS FP Data formats .....	8-4
MIPS Implementation of IEEE754.....	8-5
Floating Point Registers.....	8-6
Floating Point Exceptions/Interrupts.....	8-6
The Floating Point Control/Status Register .....	8-6
Floating Point Implementation/Revision Register.....	8-8
Guide to FP Instructions .....	8-8
Load/Store.....	8-8
Move Between Registers .....	8-9
3-Operand Arithmetic Operations.....	8-9
Unary (sign-changing) Operations.....	8-10
Conversion Operations.....	8-10
Conditional Branch and Test Instructions.....	8-10
Instruction Timing Requirements .....	8-12
Instruction Timing for Speed.....	8-12
Initialization and Enable On Demand.....	8-12
Floating Point Emulation .....	8-13
<b>Assembler Language Programming.....</b>	<b>9</b>
Syntax Overview.....	9-1
Key Points to Note .....	9-1
Register-to-Register Instructions .....	9-2
Immediate (Constant) Operands .....	9-3
Multiply/Divide.....	9-4
Load/Store Instructions.....	9-5
Unaligned Loads and Store.....	9-5
Addressing Modes .....	9-6
Gp-Relative Addressing.....	9-6
Jumps, Subroutine Calls and Branches.....	9-8
Conditional Branches.....	9-8
Co-processor Conditional Branches .....	9-9
Compare and Set.....	9-9
Coprocessor Transfers .....	9-9
Coprocessor Hazards .....	9-10
Assembler Directives .....	9-10
Sections.....	9-10
.text, .rdata, .data .....	9-10
.lit4, .lit8 .....	9-10
Program Segments in Memory .....	9-11
.bss .....	9-12
.sdata, .sbss .....	9-12
Stack and Heap .....	9-12
Special Symbols .....	9-12
Data Definition and Alignment.....	9-12

---

---

.byte, .half, .word .....	9-13
.float, .double .....	9-13
.ascii, .asciiz .....	9-13
.align .....	9-13
.comm, .lcomm .....	9-13
.space .....	9-14
Symbol Binding Attributes .....	9-14
.globl .....	9-14
.extern .....	9-15
.weakext .....	9-15
Function Directives .....	9-15
.ent, .end .....	9-15
.aent .....	9-16
.frame, .mask, .fmask .....	9-16
Assembler Control (.set) .....	9-17
.set noreorder/reorder .....	9-17
.set volatile/novolatile .....	9-17
.set noat/at .....	9-18
.set nomacro/macro .....	9-18
.set nobopt/bopt .....	9-18
The Complete Guide to Assembler Instructions .....	9-18
Alphabetic List of Assembler Instructions .....	9-30
<b>C Programming.....</b>	<b>10</b>
The Stack, Subroutine Linkage, Parameter Passing .....	10-1
Stack Argument Structure .....	10-1
Which Arguments go in What Registers .....	10-1
Examples from the C Library .....	10-2
Exotic Example; Passing Structures .....	10-2
How Printf() and Varargs Work .....	10-3
Returning Value from a Function .....	10-4
Macros for Prologues and Epilogues .....	10-4
Stack-Frame Allocation .....	10-4
Leaf Functions .....	10-4
Non-Leaf Functions .....	10-5
Functions Needing Run-Time Computed Stack Locations .....	10-7
Shared and Non-Shared Libraries .....	10-9
Sharing Code in Single-Address Space Systems .....	10-9
Sharing Code Across Address Spaces .....	10-10
An Introduction to Optimization .....	10-11
Common Optimizations .....	10-11
How to Prevent Unwanted Effects From Optimization .....	10-14
Optimizer-Unfriendly Code and How to Avoid It .....	10-15
<b>Portability Considerations .....</b>	<b>11</b>
Writing Portable C .....	11-1
C Language Standards .....	11-1
C Library Functions and POSIX .....	11-2
Data Representations and Alignment .....	11-3
Notes on Structure Layout and Padding .....	11-3
Isolating System Dependencies .....	11-5

---



Locating System Dependencies .....	11-5
Fixing Up Dependencies.....	11-5
Isolating Non-Portable Code .....	11-6
Using Assembler.....	11-6
Endianness .....	11-7
What It Means to the Programmer.....	11-8
Bitfield Layout and Endianness .....	11-9
Changing the Endianness of a MIPS CPU.....	11-10
Designing and Specifying for Configurable Endianness .....	11-10
Read-Only Instruction Memory .....	11-10
Writable (Volatile) Memory .....	11-11
Byte-Lane Swapping .....	11-11
Configurable IO Controllers .....	11-12
Portability and Endianness-Independent Code .....	11-13
Endianness-Independent Code .....	11-13
Compatibility Within the R30XX Family.....	11-13
Porting to MIPS: Frequently Encountered Issues.....	11-15
Considerations for Portability to Future Devices.....	11-16
<b>Writing Power-On Diagnostics.....</b>	<b>12</b>
Golden Rules for Diagnostics Programming .....	12-1
What Should Tests Do? .....	12-2
How to Test the Diagnostic Tests? .....	12-3
Overview of Algorithmics' Power-On Selftest.....	12-3
Starting Points.....	12-3
Control and Environment Variables .....	12-4
Reporting.....	12-4
Unexpected Exceptions During Test Sequence .....	12-5
Driving Test Output Devices .....	12-5
Restarting the System .....	12-5
Standard Test Sequence .....	12-5
Notes on the Test Sequence .....	12-6
Annotated Examples from the Test Code .....	12-9
<b>Instruction Timing and Optimization.....</b>	<b>13</b>
Notes and Examples.....	13-1
Additional Hazards .....	13-2
Early Modification of HI and LO .....	13-2
Bitfields in CPU Control Registers.....	13-3
Non-Obvious Hazards.....	13-3
<b>Software Tools for Board Bring-Up.....</b>	<b>14</b>
Tools Used in Debug .....	14-1
Initial Debugging .....	14-2
Porting Micromonitor .....	14-2
Running Micromonitor .....	14-2
Initial IDT/SIM Activity.....	14-2
A Final Note on IDT/KIT .....	14-3
<b>Software Design Examples .....</b>	<b>15</b>
Application Software .....	15-1
Memory Map .....	15-1
Starting Up.....	15-1

C Library Functions .....	15-2
Input and Output .....	15-3
Character Class Tests .....	15-3
String Functions .....	15-3
Mathematical Functions .....	15-3
Utility Functions .....	15-3
Diagnostics .....	15-4
Variable Argument Lists .....	15-4
Non-Local Jumps .....	15-4
Signals .....	15-4
Date and Time .....	15-4
Running the Program .....	15-4
Debugging the Program .....	15-5
Embedded System Software .....	15-5
Memory Map .....	15-6
Starting Up .....	15-6
Embedded System Library Functions .....	15-7
Trap and Interrupt Handling .....	15-8
Simple Interrupt Routines .....	15-8
Floating-Point Traps and Interrupts .....	15-9
Emulating Floating Point Instructions .....	15-10
Debugging .....	15-10
Unix-Like System S/W .....	15-11
Terminology .....	15-11
Components of a Process .....	15-12
System Calls and Protection .....	15-13
What the Kernel Does .....	15-13
Virtual Memory Implementation for MIPS .....	15-14
Interrupt Handling for MIPS .....	15-15
How it Works .....	15-16
<b>Assembly Language Programming Tips.....</b>	<b>16</b>
32-bit Address or Constant Values .....	16-1
Use of “Set” Instructions .....	16-1
Use of “Set” with Complex Branch Operations .....	16-2
Carry, Borrow, Overflow, and Multi-Precision Math .....	16-2
<b>Machine Instructions Reference (Appendix A).....</b>	<b>A</b>
CPU Instruction Overview .....	A-1
Instruction Classes .....	A-1
Instruction Formats .....	A-2
Instruction Notation Conventions .....	A-2
Instruction Notation Examples .....	A-3
Load and Store Instructions .....	A-4
Jump and Branch Instructions .....	A-5
Coprocessor Instructions .....	A-5
System Control Coprocessor (CP0) Instructions .....	A-6
Instruct Set Details .....	A-6
Instruction Summary .....	A-79
<b>FPA Instruction Reference (Appendix B).....</b>	<b>B</b>
FPU Instruction Set Details .....	B-1

FPU Instructions .....	B-1
Floating-Point Data Transfer .....	B-1
Floating-Point Conversions .....	B-1
Floating-Point Arithmetic .....	B-2
Floating-Point Register-to-Register Move .....	B-2
Floating-Point Branch .....	B-2
FP Computational Instructions and Valid Operands .....	B-2
FP Compare and Condition values .....	B-3
FPU Register Specifiers .....	B-3
32-bit CP1 registers.....	B-4
FPU Register Access for 32-bit CP1 Registers.....	B-5
Instruction Notation Conventions .....	B-5
Load and Store Memory .....	B-6
Instruction Descriptions .....	B-6
FPA Instruction Set Summary .....	B-27
<b>CP0 Operation Reference (Appendix C) .....</b>	<b>C</b>
CP0 Operation Details .....	C-1
MMU Operations .....	C-1
Exception Operations.....	C-1
Dand Register Movement Operations.....	C-1
Operation Descriptions .....	C-1
<b>Assembler Language Syntax (Appendix D).....</b>	<b>D</b>
<b>Object Code Formats (Appendix E).....</b>	<b>E</b>
Sections and Segments.....	E-1
ECOFF Object File Format (RISC/OS).....	E-1
File Header.....	E-2
Optional a.out Header .....	E-2
Example Loader .....	E-3
Further Reading .....	E-4
ELF (MIPS ABI).....	E-4
File Header.....	E-4
Program Header .....	E-5
Example Loader .....	E-6
Further Reading .....	E-7
Object Code Tools .....	E-7
<b>Glossary of Common "MIPS" Terms.....</b>	<b>F</b>
 <b>DRAWINGS</b>	
1.1 MIPS 5-Stage Pipeline.....	1-2
1.2 The Pipeline and Branch Delays.....	1-7
1.3 The Pipeline and Load Delays .....	1-8
3.1 PRId Register Fields .....	3-4
3.2 Fields in Status Register.....	3-4
3.3 Fields in the Cause Register.....	3-7
3.4 Fields in the R3071/81 Config Register.....	3-8
3.5 Fields in the R3041 Config (Cache Configuration)Register.....	3-9
3.6 Fields in the R3041 Bus Control (BusCtrl) Register .....	3-10
5.1 Direct Mapped Cache .....	5-1
6.1 EntryHi and EntryLo Register Fields .....	6-3

6.2	EntryHi and EntryLo Register Fields .....	6-3
6.3	Fields in the Index Register .....	6-4
6.4	Fields in the Random Register.....	6-4
6.5	Fields in the Context Register.....	6-4
8.1	FPA Control/Status Register Fields .....	8-6
8.2	FPA Implementation/Revision Register .....	8-8
9.1	Program Segments in Memory .....	9-11
10.1	Stackframe for a Non-Leaf Function .....	10-5
11.1	Structure Layout and Padding in Memory.....	11-3
11.2	Data Representation with #pragma Pack(1) .....	11-4
11.3	Data Representation with #pragma Pack(2) .....	11-5
11.4	Typical Big-Endians Picture .....	11-8
11.5	Little Endians Picture.....	11-8
11.6	Bitfields and Big-Endian.....	11-9
11.7	Bitfields and Little-Endian.....	11-10
11.8	Garbled String Storage when Mixing Modes .....	11-11
11.9	Byte-Lane Swapper.....	11-12
15.1	Memory Layout of a BSD Process .....	15-12
A.1	CPU Instruction Formats .....	A-2

## TABLES

1.1	R30xx Family Members Compared.....	1-4
2.1	Conventional Names of Registers with Usage Mnemonics.....	2-2
3.1	Summary of CPU Control Registers (Not MMU) .....	3-3
3.2	ExcCode Values: Different kinds of Exceptions .....	3-7
4.1	Reset and Exception Entry Points (Vectors) for R30xx Family .....	4-3
4.2	Interrupt Bitfields and Interrup Pins .....	4-13
6.1	CPU Control Registers for Memory Management .....	6-3
8.1	Floating Point Data Formats .....	8-4
8.2	Rounding Modes Encoded in FP Control/Status Register.....	8-7
8.4	FP Move Instructions.....	8-9
8.5	FPA 3-Operand Arithmetic.....	8-10
8.6	FPA Sign-Changing Operators .....	8-10
8.7	FPA Data Conversion Operations.....	8-10
8.8	FP Test Instructions .....	8-11
9.1	Assembler Register and Identifier Conventions .....	9-20
9.2	Assembler Instructions.....	9-20
12.1	Test Sequence in Brief .....	12-5
16.1	32-bit Immediate Values.....	16-1
16.2	Add-With-Carry .....	16-2
16.3	Subtract-with-Borrow Operation .....	16-3
A.1	CPU Instruction Operation Notations.....	A-3
A.2	Load and Store Common Function.....	A-4
A.3	Access Type Specifications for Load/Store.....	A-5
B.1	Format Field Decoding .....	B-2
B.2	Logical Negation of Predicates by Condition True/False.....	B-3
B.3	Valid FP Operand Specifiers with 32-bit Coprocessor 1 Registers.....	B-4
B.4	Load and Store Common Functions .....	B-6

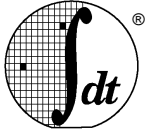

Integrated Device Technology, Inc.

## INTRODUCTION

## CHAPTER 1

IDT's R30xx family of RISC microcontrollers family includes the R3051, R3052, R3071, R3081 and R3041 processors. The different members of the family offer different price/performance trade-offs, but are all basically integrated versions of the MIPS R3000A CPU. The R3000A CPU is well known for the high-performance Unix systems implemented around it; less publicized but equally impressive is the performance it has brought to a wide variety of embedded applications.

IDT's RISController family also includes devices built around MIPS R4000 64-bit microprocessor technology. These devices, such as the IDT R4600 Orion microprocessor, offer even higher levels of performance than the R3000A derivative family. However, these devices also feature slightly different OS models, and allow 64-bit kernels and applications. Thus, they are sufficiently different from the R30xx family that this manual is focused exclusively on the R30xx family.

This manual is aimed at the programmer dealing with the IDT R30xx family components. Although most programming occurs using a high-level language (usually "C"), and with little awareness of the underlying system or processor architecture, certain operations require the programmer to use assembly programming, and/or be aware of the underlying system or processor structure. This manual is designed to be consulted when addressing these types of issues.

### WHAT IS A RISC?

The MIPS CPU is one of the "RISC" CPUs, born out of a particularly fertile period of academic research and development. RISC CPUs ("Reduced Instruction Set Computer") share a number of architectural attributes to facilitate the implementation of high-performance processors. Most new architectures (as opposed to implementations) since 1986 owe their remarkable performance to features developed a few years earlier by a couple of seminal research projects. Someone commented that "a RISC is any computer architecture defined after 1984"; although meant as a jibe at the industry's use of the acronym, the comment's truth also derives from the widespread acceptance of the conclusions of that research.

One of these was the "MIPS" project at Stanford University. The project name MIPS puns the familiar "millions of instructions per second" by taking its name from the key phrase "Microcomputer without Interlocked Pipeline Stages". The Stanford group's work showed that pipelining, a well-known technique for speeding up computers, had been under-exploited by earlier architectures.

## PIPELINES

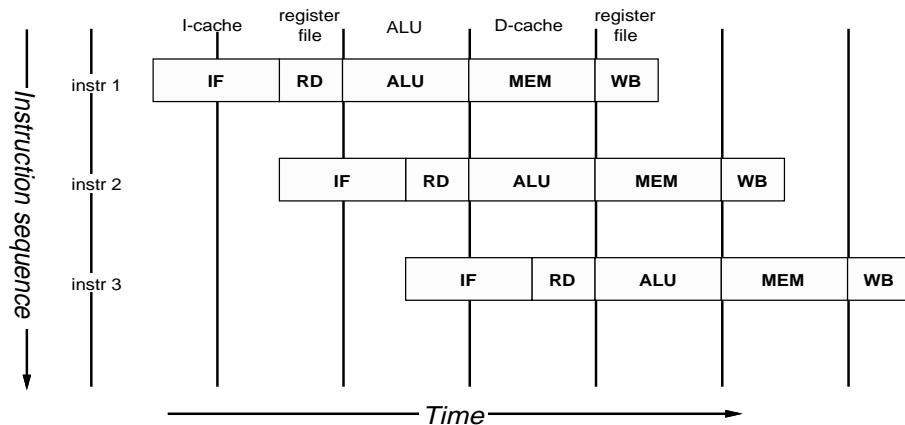

**Figure 1.1. MIPS 5-stage pipeline**

Pipelined processors operate by breaking instruction execution into multiple small independent “stages”; since the stages are independent, multiple instructions can be in varying states of completion at any one time. Also, this organization tends to facilitate higher frequencies of operation, since very complex activities can be broken down into “bite-sized” chunks. The result is that multiple instructions are executing at any one time, and that instructions are initiated (and completed) at very high frequency. MIPS has consistently been among the most aggressive in the utilization of these techniques.

Pipelining depends for its success on another technique; using *caches* to reduce the amount of time spent waiting for memory. The MIPS R3000A architecture uses separate instruction and data caches, so it can fetch an instruction and read or write a memory variable in the same clock phase. By mating high-frequency operation to high memory-bandwidth, very high-performance is achieved.

In CISC architectures, caches are often seen as part of memory. A RISC architecture makes more sense if the dual caches are regarded as very much part of the CPU; in fact, the pipelines of virtually all RISC processors require caches to maintain execution. The CPU normally runs from cache and a cache miss (where data or instructions have to be fetched from memory) is seen as an exceptional event.

For the R3000A and its derivatives, instruction execution is divided into five phases (called *pipestages*), with each pipestage taking a fixed amount of time (see “MIPS 5-stage pipeline” on page 1-2). Again, note that this model assumes that instruction fetches and data accesses can be satisfied from the processor caches at the processor operation frequency. All instructions are rigidly defined to follow the same sequence of pipestages, even where the instruction does nothing at some stage.

The net result is that, so long as it keeps hitting the cache, the CPU starts an instruction every clock.

“Figure 1.1. MIPS 5-stage pipeline”, illustrates this operation. Instruction execution activity can be described as occurring in the individual pipestages:

- *IF*: (“instruction fetch”) gets the next instruction from the instruction cache (*I-cache*).
- *RD*: (“read registers”) decodes the instruction and fetches the contents of any CPU registers it uses.
- *ALU*: (“arithmetic/logic unit”) performs an arithmetic or logical operation in one clock (floating point math and integer multiply/divide can’t be done in one clock and are done differently; this is described later).

- *MEM*: the stage where the instruction can read/write memory variables in the data cache (*D-cache*). Note that for typical programs, three out of four instructions do nothing in this stage; but allocating the stage to each instruction ensures that the processor never has two instructions wanting the data cache at the same time.
- *WB*: (“write back”) store the value obtained from an operation back to the register file.

A rigid pipeline does limit the kinds of things instructions can do; in particular:

- *Instruction length*: ALL instructions are 32 bits (exactly one machine “word”) long, so that they can be fetched in a constant time. This itself discourages complexity; there are not enough bits in the instruction to encode really complicated addressing modes, for example.
- *No arithmetic on memory variables*: data from cache or memory is obtained only in stage 4, which is much too late to be available to the ALU. Memory accesses occur only as simple load or store instructions which move the data to or from registers (this is described as a “load/store architecture”).

However, the MIPS project architects also attended to the best thinking of the time about what makes a CPU an easy target for efficient optimizing compilers. So MIPS CPUs have 32 general purpose registers, 3-operand arithmetical/logical instructions and eschew complex special-purpose instructions which compilers can’t usually generate.

## THE IDT R3xxx FAMILY CPUS

MIPS Corporation was formed in 1984 to make a commercial version of the Stanford MIPS CPU. The commercial CPU was enhanced with memory management hardware, first appearing late in 1985 as the R2000. An ambitious external floating point math co-processor (the R2010 FPA) first shipped in mid-87. The R3000, shipped in 1988, is almost identical from the programmer’s viewpoint (although small hardware enhancements combined to give a substantial boost to performance). The R3000A was done in 1989, to improve the frequency of operation over the original R3000 (other minor enhancements were added, such as the ability for user tasks to operate with the opposite “endianness” from the kernel).

The R2000/R3000 chips include a cache controller – the implementation of external caches merely required a few industry standard SRAMs and some address latches. The math co-processor shares the cache buses to interpret instructions (in parallel with the integer CPU) and transfer operands and results between the FPA and memory or the integer CPU.

The division of function was ingenious, practical and workable, allowing the R2000/3000 generation to be built without extravagant ultra-high pin-count packages. However, as clock speeds increased the very high-speed signals in the cache interface increased design complexity and limited operational frequency. In addition, overall chip count for the basic execution core proved to be a limitation for area and power sensitive embedded systems.

The R3051, R3052, R3071, R3081 and R3041 are the members (so far) of a family of products defined, designed, and manufactured by IDT. The chips integrate the functions of the R3000A CPU, cache memory and (R3081 only) math co-processor. This means that all the fastest logic is on chip; so the integrated chips are not only cheaper and smaller than the original implementation, but also much easier to use.

The parts differ in their cache sizes, whether they include onchip MMU and/or FPA, clock rates and packaging options. In addition, although all parts can be used pin-compatibly, certain products feature optional enhancements in their bus-interface that may serve to reduce system cost or complexity, and other subtle enhancements for cost or performance. The major differences are summarized in “Table 1.1. R30xx family members compared”.

Part	Cache I + D	MMU	FPA	Clock (MHz)	Package Options	System Interface
3051	4K + 1K	-	-	20-40	PLCC	32-bit MUX'ed A/D
3051E		×				
3052	8K + 2K	-	-	20-40	PLCC	32-bit MUX'ed A/D
3052E		×				
3081	16K+4K/ 8K+8K	-		20-50	PLCC	Optional 1/2 frequency bus operation Optional 1x Clock Input
3081E	16K+4K/ 8K+8K	×	×			
3071	16K+4K/ 8K+8K	-		33-50	PLCC	1/2 frequency bus operation 1x Clock Input
3071E	16K+4K/ 8K+8K	×	-			
3041	2K + 0.5K	-	-	16-25	PLCC TQFP	Variable port width interface.

**Table 1.1. R30xx family members compared**

## MIPS ARCHITECTURE LEVELS

There are multiple generations of the MIPS architecture. The most commonly discussed are the MIPS-1, MIPS-2, and MIPS-3 architectures.

MIPS-1 is the ISA found in the R2000 and R3000 generation CPUs. It is a 32-bit ISA, and defines the basic instruction set. Any application written with the MIPS-1 instruction set will operate correctly on all generations of the architecture.

The MIPS-2 ISA is also 32-bit. It adds some instructions to speed up floating point data movement, branch-likely instructions, and other minor enhancements. This was first implemented in the MIPS R6000 ECL microprocessor.

The MIPS-3 ISA is a 64-bit ISA. In addition to supporting all MIPS-1 and MIPS-2 instructions, the MIPS-3 ISA contains 64-bit equivalents of certain earlier instructions that are sensitive to operand size (e.g. load double and load word are both supported), including doubleword (64-bit) data movement and arithmetic. This ISA was first implemented in the R4000 as a clean (“seamless”) transition from the existing 32-bit architecture.

Note that these ISA levels do not necessarily imply a particular structure for the MMU, caches, exception model, or other kernel specific resources. Thus, different implementations of ISA compatible chips may require different kernels.

In the case of the R30xx family, all devices implement the MIPS-1 ISA. Many devices are also kernel compatible with the R3000A, but some devices (most notably those without an MMU) may require small kernel changes or different boot modules†.

## MIPS-1 COMPARED WITH CISC ARCHITECTURES

Although the MIPS architecture is fairly straight-forward, there are a few features, visible only to assembly programmers, which may at first appear surprising. In addition, operations familiar to CISC architectures are

† Historically, many embedded MIPS applications have run exclusively out of the “kseg0 and kseg1” memory regions (described later in the book). For these applications, the presence or absence of the MMU is largely irrelevant.



irrelevant to the MIPS architecture. For example, the MIPS architecture does not mandate a stack pointer or stack usage; thus, programmers may be surprised to find that push/pop instructions do not exist directly.

The most notable of these features are summarized here.

### Unusual instruction encoding features

- *All instructions are 32-bits long*: as mentioned above. This means, for example, that it is impossible to incorporate a 32-bit constant into a single instruction (there would be no instruction bits left to encode the operation and the registers!). A “load immediate” instruction is limited to a 16-bit value; a special “load upper immediate” must be followed by an “or immediate” to put a 32-bit constant value into a register.
- *Instruction actions must fit the pipeline*: actions can only be carried out in the designated pipeline phase, and must be complete in one clock. For example, the register writeback phase provides for just one value to be stored in the register file, so instructions can only change one register.
- *3-operand instructions*: arithmetic/logical operations don’t have to specify memory locations, so there are plenty of instruction bits to define two independent source and one destination register. Compilers love 3-operand instructions, which give optimizers more scope to improve the code which handles complex expressions.
- *32 registers*: the choice of 32 has become universal; compilers like a large (but not necessarily too large) number of registers, but there is a cost in context-saving and in encoding the registers to be used by an instruction. Register \$0 always returns zero, to give a compact encoding of that useful constant.
- *No condition codes*: the MIPS architecture does not provide condition code flags implicitly set by arithmetical operations. The motivation is to make sure that execution state is stored in one place – the register file. Conditional branches (in MIPS) test a single register for sign/zero, or a pair of registers for equality.

### Addressing and memory accesses

- *Memory references are always register loads and stores*: arithmetic on memory variables upsets the pipeline, so is not done. Memory references only occur due to explicit load or store instructions. The large register file allows multiple variables to be “on-chip” simultaneously.
- *Only one data addressing mode*: all loads and stores define the memory location with a single base register value modified by a 16-bit signed displacement. Note that the assembler/compiler tools can use the \$0 register, along with the immediate value, to synthesize additional addressing modes from this one directly supported mode.
- *Byte-addressed*: the instruction set includes load/store operations for 8- and 16-bit variables (referred to as *byte* and *halfword*). Partial-word load instructions come in two flavors – sign-extend and zero-extend.
- *Loads/stores must be address-aligned* : memory word operations can only load or store data from a single 4-byte aligned word; halfword operations must be aligned on half-word addresses. Many CISC microprocessors will load/store a multi-byte item from any byte address (although unaligned transfers always take longer). Techniques to generate code which will handle unaligned data efficiently will be explained later.
- *Jump instructions*: The smallest op-code field in a MIPS instruction is 6 bits; leaving 26 bits to define the target of a jump. Since all instructions are 4-byte aligned in memory the two least-significant

address bits need not be stored, allowing an address range of  $2^{28} = 256\text{Mbytes}$ . Rather than make this branch PC-relative, this is interpreted as an absolute address within a 256Mbyte “segment”. In theory, this could impose a limit on the size of a single program; in reality, it hasn’t been a problem.

Branches out of segment can be achieved by using a *jr* instruction, which uses the contents of a register as the target.

Conditional branches have only a 16-bit displacement field ( $2^{18}$  byte range since instructions are 4-byte aligned) which is interpreted as a signed PC-relative displacement. Compilers can only code a simple conditional branch instruction if they know that the target will be within 128Kbytes of the instruction following the branch.

## Operations not directly supported

- *No byte or halfword arithmetic*: all arithmetical and logical operations are performed on 32-bit quantities. Byte and/or halfword arithmetic would require significant extra resources, many more op-codes, and is an understandable omission. Most C programmers will use the *int* data type for most arithmetic, and for MIPS an *int* is 32 bits and such arithmetic will be efficient. C’s rules are to perform arithmetic in *int* whenever any source or destination variable is as long as *int*.

However, where a program explicitly does arithmetic as *short* the compiler must insert extra code to make sure that wraparound and overflows have the appropriate effect.

- *No special stack support*: conventional MIPS assembler usage does define a *sp* register, but the hardware treats *sp* just like any other register. There is a recommended format for the stack frame layout of subroutines, so that programs can mix modules from different languages and compilers; it is recommended that programmers stick to these conventions, but they have no relationship to the hardware.
- *Minimal subroutine overhead*: there is one special feature; jump instructions have a “jump and link” option which stores the return address into a register. \$31 is the default, so for convenience and by convention \$31 becomes the “return address” register.
- *Minimal interrupt overhead*: The MIPS architecture makes very few presumptions about system exception handling, allowing fast response and a wide variety of software models. In the R30xx family, the CPU stashes away the restart location in the special register *EPC*, modifies the machine state just enough to signal why the trap happened and to disallow further interrupts; then it jumps to a single predefined location† in low memory. Everything else is up to the software.

Just to emphasize this: on an interrupt or trap a MIPS CPU *does not* store anything on a stack, or write memory, or preserve any registers by itself.

By convention, two registers (\$k0, \$k1; register conventions are explained in chapter 2) are reserved so that interrupt/trap routines can “bootstrap” themselves – it is impossible to do anything on a MIPS CPU without using some registers. For a program running in any system which takes interrupts or traps, the values of these registers may change at any time, and thus should not be used.

---

† One particular kind of trap (a TLB miss on an address in the user-privilege address space) has a different dedicated entry point.

## Multiply and divide operations

The MIPS CPU does have an integer multiply/divide unit; worth mentioning because many RISC machines don't have multiply hardware. The multiply unit is relatively independent of the rest of the CPU, with its own special output registers.

## Programmer-visible pipeline effects

In addition to the discussion above, programmers of R3xxx architecture CPUs also must be aware of certain effects of the MIPS pipeline. Specifically, the results of certain operations may not be available in the immediately subsequent instruction; the programmer may need to be explicitly aware of such cases.

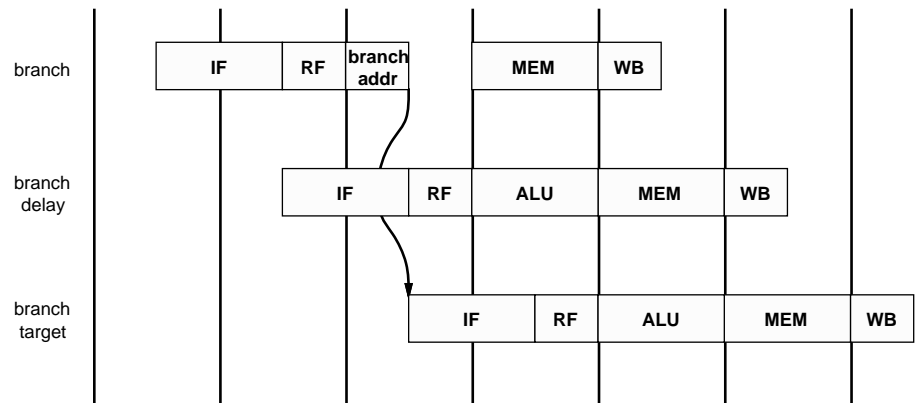

**Figure 1.2. The pipeline and branch delays**

- *Delayed branches*: the pipeline structure of the MIPS CPU (see "Figure 1.2. The pipeline and branch delays") means that when a jump instruction reaches the "execute" phase and a new program counter is generated, the instruction after the jump will already have been decoded. Rather than discard this potentially useful work, the architecture rules state that the *instruction after a branch is always executed before the instruction at the target of the branch*.

"Figure 1.2. The pipeline and branch delays" show that a special path is provided through the ALU to make the branch address available a half-clock early, ensuring that there is only a one cycle delay before the outcome of the branch is determined and the appropriate instruction flow (branch taken or not taken) is initiated.

It is the responsibility of the compiler system or the assembler-programmer to allow for and even to exploit this "branch delay slot"; it turns out that it is usually possible to arrange code such that the instruction in the "delay slot" does useful work. Quite often, the instruction which would otherwise have been placed before the branch can be moved into the delay slot.

This can be a bit tricky on a conditional branch, where the branch delay instruction must be (at least) harmless on the path where it isn't wanted. Where nothing useful can be done the delay slot is filled with a "**nop**" (no-op, or no-operation) instruction.

Many MIPS assemblers will hide this feature from the programmer unless explicitly told not to, as described later.

- *Load data not available to next instruction*: another consequence of the pipeline is that a load instruction's data arrives from the cache/memory system AFTER the *next* instruction's ALU phase starts – so it is not possible to use the data from a load in the following instruction. See "Figure 1.3. The pipeline and load delays" for how this works. On the MIPS-1 architecture, the programmer must insure that this rule is not violated

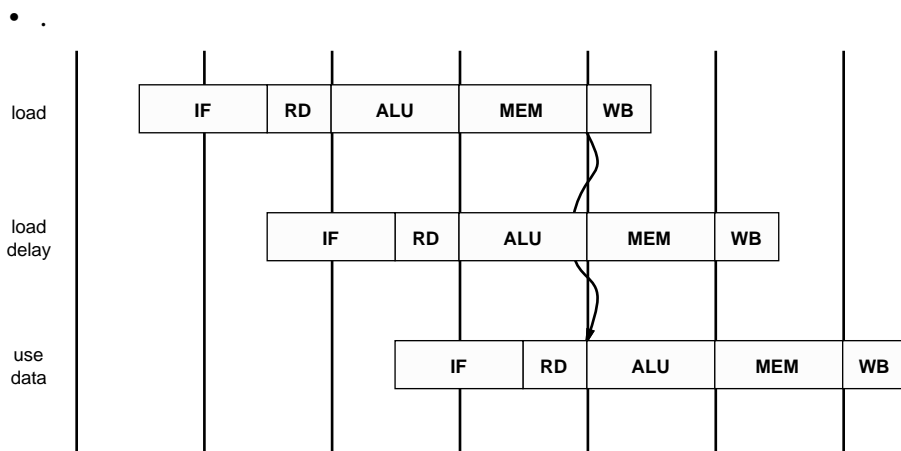

**Figure 1.3. The pipeline and load delays**

Again, most assemblers will hide this if they can. Frequently, the assembler can move an instruction which is independent of the load into the load delay slot; in the worst case, it can insert a **NOP** to insure proper program execution.

### A NOTE ON MACHINE AND ASSEMBLER LANGUAGE

To simplify assembly level programming, the MIPS Corp's assembler (and many other MIPS assemblers) provides a set of "synthetic" instructions. Typically, a synthetic instruction is a common assembly level operation that the assembler will map into one or more true instructions. This mapping can be more intelligent than a mere macro expansion. For example, an immediate load may map into one instruction if the datum is small enough, or multiple instructions if the datum is larger. However, these instructions can dramatically simplify assembly level programming. For example, the programmer just writes a "load immediate" instruction and the assembler will figure out whether it needs to generate multiple machine instructions or can get by with just one (in this example, depending on the size of the immediate datum).

This is obviously useful, but can be confusing. This manual will try to use synthetic instructions sparingly, and indicate when it happens. Moreover, the instruction tables below will consistently distinguish between synthetic and machine instructions.

These features are there to help human programmers; most compilers generate instructions which are one-for-one with machine code. However, some compilers will in fact generate synthetic instructions.

Helpful things the assembler does:

- **32-bit load immediates:** The programmer can code a load with any value (including a memory location which will be computed at link time), and the assembler will break it down into two instructions to load the high and low half of the value.
- **Load from memory location:** The programmer can code a load from a memory-resident variable. The assembler will normally replace this by loading a temporary register with the high-order half of the variable's address, followed by a load whose displacement is the low-order half of the address.

Of course, this does not apply to variables defined inside C functions, which are implemented either in registers or on the stack.

- **Efficient access to memory variables:** some C programs contain many references to *static* or *extern* variables, and a two-instruction sequence to load/store any of them is expensive. Some compilation systems, with run-time support, get around this. Certain variables are selected at compile/assemble time (by default MIPS Corp's assembler selects variables which occupy 8 or less bytes of storage)

and kept together in a single section of memory which must end up smaller than 64Kbytes. The run-time system then initializes one register (\$28 or *gp* (global pointer) by convention) to point to the middle of this section.

Loads and stores to these variables can now be coded as a single *gp* relative load or store.

- *More types of branch condition*: the assembler synthesizes a full set of branches conditional on an arithmetic test between two registers.
- *Simple or different forms of instructions*: unary operations such as *not* and *neg* are produced as a *nor* or *sub* with the zero-valued register \$0.

Two-operand forms of 3-operand instructions can be written; the assembler will put the result back into the first-specified register.

- *Hiding the branch delay slot*: in normal coding most assemblers will not allow access the branch delay slot. MIPS Corp.'s assembler, in particular, is exceptionally ingenious and may re-organize the instruction sequence substantially in search of something useful to do in the delay slot. An assembler directive ".noreorder" is available where this must not happen.
- *Hiding the load delay*: many assemblers will detect an attempt to use the result of a load in the next instruction, and will either move code around or insert a **nop**.
- *Unaligned transfers*: the "unaligned" load/store instructions will fetch halfword and word quantities correctly, even if the target address turns out to be unaligned.
- *Other pipeline corrections*: some instructions (such as those which use the integer multiply unit) have additional constraints that are implementation specific (see the Appendix on hazards). Many assemblers will just "handle" these cases automatically, or at least warn the programmer about possible hazards violations.
- *Other optimizations*: some MIPS instructions (particularly floating point) take multiple clocks to produce results. However, the hardware is "interlocked", so the programmer does not need to be aware of these delays to write correct programs. But MIPS Corp.'s assembler is particularly aggressive in these circumstances, and will perform substantial code movement to try to make it run faster. This may need to be considered when debugging.

In general, it is best to use a dis-assembler utility to disassemble a resulting binary during debug. This will show the system designers the true code sequence being executed, and thus "uncover" the modifications made by the assembler or compiler.

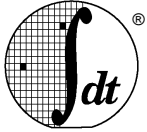

## **PROGRAMMER'S VIEW OF THE PROCESSOR ARCHITECTURE**

This chapter describes the assembly programmer's view of the CPU architecture, in terms of registers, instructions, and computational resources. This viewpoint corresponds, for example, to an assembly programmer writing user applications (although more typically, such a programmer would use a high-level language).

Information about kernel software development (such as handling interrupts, traps, and cache and memory management) are described in later chapters.

### **Registers**

There are 32 general purpose registers: \$0 to \$31. Two, and only two, are special to the hardware:

- \$0 always returns zero, no matter what software attempts to store to it.
- \$31 is used by the normal subroutine-calling instruction (*jal*) for the return address. Note that the call-by-register version (*jalr*) can use ANY register for the return address, though practice is to use only \$31.

In all other respects all registers are identical and can be used in any instruction (\$0 can be used as the destination of instructions; the value of \$0 will remain unchanged, however, so the instruction would be effectively a **NOP**).

In the MIPS architecture the “program counter” is not a register, and it is probably better to not think of it that way. The return address of a *jal* is two instructions later in sequence (the instruction after the jump delay slot instruction); the instruction after the call is the call's “delay slot” and is typically used to set up the last parameter.

There are no condition codes and nothing in the “status register” or other CPU internals is of any consequence to the user-level programmer.

There are two registers associated with the integer multiplier. These registers, referred to as “HI” and “LO”, contain the 64-bit product result of a multiply operation, or the quotient and remainder of a divide.

The floating point math co-processor (called *FPA* for floating point accelerator), if available, adds 32 floating point registers<sup>†</sup>; in simple assembler language they are just called \$0 to \$31 again – the fact that these are floating point registers is implicitly defined by the instruction. Actually, only the 16 even-numbered registers are usable for math; but they can be used for either single-precision (32 bit) or double-precision (64-bit) numbers. When performing double-precision arithmetic, odd numbered register \$N+1 holds the remaining bits of the even numbered register identified \$N. Only moves between integer and FPA, or FPA load/store instructions, ever refer to odd-numbered registers (and even then the assembler helps the programmer forget...)

---

<sup>†</sup> The FPA also has a different set of registers called “co-processor 1 registers” for control purposes. These are typically used to manage the actions/state of the FPA, and should not be confused with the FPA data registers.

## Conventional names and uses of general-purpose registers

Although the hardware makes few rules about the use of registers, their practical use is governed by a number of conventions. These conventions allow inter-changeability of tools, operating systems, and library modules. It is strongly recommended that these conventions be followed.

Reg No	Name	Used for
0	zero	Always returns 0
1	at	(assembler temporary) Reserved for use by assembler
2-3	v0-v1	Value (except FP) returned by subroutine
4-7	a0-a3	(arguments) First four parameters for a subroutine
8-15	t0-t7	(temporaries) subroutines may use without saving
24-25	t8-t9	
16-23	s0-s7	Subroutine “register variables”; a subroutine which will write one of these must save the old value and restore it before it exits, so the <i>calling</i> routine sees their values preserved.
26-27	k0-k1	Reserved for use by interrupt/trap handler - may change under your feet
28	gp	global pointer - some runtime systems maintain this to give easy access to (some) “static” or “extern” variables.
29	sp	stack pointer
30	s8/fp	9th register variable. Subroutines which need one can use this as a “frame pointer”.
31	ra	Return address for subroutine

**Table 2.1. Conventional names of registers with usage mnemonics**

With the conventional uses of the registers go a set of conventional names. Given the need to fit in with the conventions, use of the conventional names is pretty much mandatory. The common names are described in Table 2.1, “Conventional names of registers with usage mnemonics”.

### Notes on conventional register names

- *at*: this register is reserved for use inside the synthetic instructions generated by the assembler. If the programmer must use it explicitly the directive *.noat* stops the assembler from using it, but then there are some things the assembler won't be able to do.
- *v0-v1*: used when returning non-floating-point values from a subroutine. To return anything bigger than  $2 \times 32$  bits, memory must be used (described in a later chapter).
- *a0-a3*: used to pass the first four non-FP parameters to a subroutine. That's an occasionally-false oversimplification; the actual convention is fully described in a later chapter.
- *t0-t9*: by convention, subroutines may use these values without preserving them. This makes them easy to use as “temporaries” when evaluating expressions – but a caller must remember that they may be destroyed by a subroutine call.
- *s0-s8*: by convention, subroutines must guarantee that the values of these registers on exit are the same as they were on entry – either by not using them, or by saving them on the stack and restoring before exit.

This makes them eminently suitable for use as “register variables” or for storing any value which must be preserved over a subroutine call.

- *k0-k1*: reserved for use by the trap/interrupt routines, which will not restore their original value; so they are of little use to anyone else.
- *gp*: (global pointer). If present, it will point to a load-time-determined location in the midst of your static data. This means that loads and stores to data lying within 32Kbytes either side of the *gp* value can be performed in a single instruction using *gp* as the base register.

Without the global pointer, loading data from a static memory area takes two instructions: one to load the most significant bits of the 32-bit constant address computed by the compiler and loader, and one to do the data load.

To use *gp* a compiler must know at compile time that a datum will end up linked within a 64Kbyte range of memory locations. In practice it can't know, only guess. The usual practice is to put "small" global data items in the area pointed to by *gp*, and to get the linker to complain if it still gets too big. The definition of what is "small" can typically be specified with a compiler switch (most compilers use "-G"). The most common default size is 8 bytes or less.

Not all compilation systems or OS loaders support *gp*.

- *sp*: (stack pointer). Since it takes explicit instructions to raise and lower the stack pointer, it is generally done only on subroutine entry and exit; and it is the responsibility of the subroutine being called to do this. *sp* is normally adjusted, on entry, to the lowest point that the stack will need to reach at any point in the subroutine. Now the compiler can access stack variables by a constant offset from *sp*. Stack usage conventions are explained in a later chapter.
- *fp*: (also known as *s8*). A subroutine will use a "frame pointer" to keep track of the stack if it wants to use operations which involve extending the stack by an amount which is determined at run-time. Some languages may do this explicitly; assembler programmers are always welcome to experiment; and (for many toolchains) C programs which use the "alloca" library routine will find themselves doing so.

In this case it is not possible to access stack variables from *sp*, so *fp* is initialized by the function prologue to a constant position relative to the function's stack frame. Note that a "frame pointer" subroutine may call or be called by subroutines which do not use the frame pointer; so long as the functions it calls preserve the value of *fp* (as they should) this is OK.

- *ra*: (return address). On entry to any subroutine, *ra* holds the address to which control should be returned – so a subroutine typically ends with the instruction "jr *ra*".

Subroutines which themselves call subroutines must first save *ra*, usually on the stack.

### Integer multiply unit and registers

MIPS' architects decided that integer multiplication was important enough to deserve a hard-wired instruction. This is not so common in RISCs, which might instead:

- implement a "multiply step" which fits in the standard integer execution pipeline, and require software routines for every multiplication (e.g. Sparc or AM29000); or
- perform integer multiplication in the floating point unit – a good solution but which compromises the optional nature of the MIPS floating point "co-processor".

The multiply unit consumes a small amount of die area, but dramatically improves performance (and cache performance) over "multiply step" operations. It's basic operation is to multiply two 32-bit values together to produce a 64-bit result, which is stored in two 32-bit



registers (called “hi” and “lo”) which are private to the multiply unit. Instructions *mfhi*, *mflo* are defined to copy the result out into general registers.

Unlike results for integer operations, the multiply result registers are *interlocked*. An attempt to read out the results before the multiplication is complete results in the CPU being stopped until the operation completes.

The integer multiply unit will also perform an integer division between values in two general-purpose registers; in this case the “lo” register stores the quotient, and the “hi” register the remainder.

In the R30xx family, multiply operations take 12 clocks and division takes 35. The assembler has a synthetic multiply operation which starts the multiply and then retrieves the result into an ordinary register. Note that MIPS Corp.’s assembler may even substitute a series of shifts and adds for multiplication by a constant, to improve execution speed.

Multiply/divide results are written into “hi” and “lo” as soon as they are available; the effect is not deferred until the writeback pipeline stage, as with writes to general purpose (GP) registers. If a *mfhi* or *mflo* instruction is interrupted by some kind of exception before it reaches the writeback stage of the pipeline, it will be aborted with the intention of restarting it. However, a subsequent multiply instruction which has passed the ALU stage will continue (in parallel with exception processing) and would overwrite the “hi” and “lo” register values, so that the re-execution of the *mfhi* would get wrong (i.e. new) data. For this reason it is recommended that a multiply should not be started within two instructions of an *mfhi*/*mflo*. The assembler will avoid doing this where it can.

Integer multiply and divide operations never produce an exception, though divide by zero produces an undefined result. Compilers will often generate code to trap on errors, particularly on divide by zero. Frequently, this instruction sequence is placed after the divide is initiated, to allow it to execute concurrently with the divide (and avoid a performance loss).

Instructions *mthi*, *mtlo* are defined to setup the internal registers from general-purpose registers. They are essential to restore the values of “hi” and “lo” when returning from an exception, but probably not for anything else.

## Instruction types

A full list of R30xx family integer instructions is presented in Appendix A. Floating point instructions are listed in Appendix B of this manual. Currently, floating point instructions are only available in the R3081, and are described in the R3081 User’s Manual.

The MIPS-1 ISA uses only three basic instruction encoding formats; this is one of the keys to the high-frequencies attained by RISC architectures.

Instructions are mostly in numerical order; to simplify reading, the list is occasionally re-ordered for clarity.

Throughout this manual, the description of various instructions will also refer to various subfields of the instruction. In general, the following typical nomenclature is used:

- op     The basic op-code, which is 6 bits long. Instructions which large sub-fields (for example, large immediate values, such as required for the “long” *j/jal* instructions, or arithmetic with a 16-bit constant) have a unique “op” field. Other instructions are classified in groups sharing an “op” value, distinguished by other fields (“op2” etc.).
- rs, rs1,     One or two fields identifying source registers.
- rs2
- rd     The register to be changed by this instruction.
- sa     Shift-amount: How far to shift, used in shift-by-constant instructions.

- op2** Sub-code field used for the 3-register arithmetic/logical group of instructions (*op* value of zero).
- offset** 16-bit signed *word* offset defining the destination of a “PC-relative” branch. The branch target will be the instruction “offset” words away from the “delay slot” instruction *after* the branch; so a branch-to-self has an offset of -1.
- target** 26-bit *word* address to be jumped to (it corresponds to a 28-bit byte address, which is always word-aligned). The long *j* instruction is rarely used, so this format is pretty much exclusively for function calls (*jal*).

The high-order 4 bits of the target address can't be specified by this instruction, and are taken from the address of the jump instruction. This means that these instructions can reach anywhere in the 256Mbyte region around the instructions' location. To jump further use a *jr* (jump register) instruction.

- constant** 16-bit integer constant for “immediate” arithmetic or logic operations.
- mf** Yet another extended opcode field, this time used by “co-processor” type instructions.
- rg** Field which may hold a source or destination register.
- crg** Field to hold the number of a CPU control register (different from the integer register file). Called “crs”/“crd” in contexts where it must be a source/destination respectively.

The instruction encodings have been chosen to facilitate the design of a high-frequency CPU. Specifically:

- The instruction encodings do reveal portions of the internal CPU design. Although there are variable encodings, those fields which are required very early in the pipeline are encoded in a very regular way:
- *Source registers are always in the same place*: so that the CPU can fetch two instructions from the integer register file without any conditional decoding. Some instructions may not need both registers – but since the register file is designed to provide two source values on every clock nothing has been lost.
- *16-bit constant is always in the same place*: permitting the appropriate instruction bits to be fed directly into the ALU's input multiplexer, without conditional shifts.

### Loading and storing: addressing modes

As mentioned above, there is only one basic “addressing mode”. Any load or store machine instruction can be written as:

```
operation dest-reg, offset(src-reg)
e.g.:lw $1, offset($2); sw $3, offset($4)
```

Any of the GP registers can be used for the destination and source. The *offset* is a signed, 16-bit number (so can be anywhere between -32768 and 32767); the program address used for the load is the sum of *dest-reg* and the *offset*. This address mode is normally enough to pick out a particular member of a C structure (“offset” being the distance between the start of the structure and the member required); it implements an array indexed by a constant; it is enough to reference function variables from the stack or frame pointer; to provide a reasonable sized global area around the *gp* value for static and extern variables.

The assembler provides the semblance of a simple direct addressing mode, to load the values of memory variables whose address can be computed at link time.

More complex modes such as double-register or scaled index must be implemented with sequences of instructions.

### Data types in Memory and registers

The R30xx family CPUs can load or store between 1 and 4 bytes in a single operation. Naming conventions are used in the documentation and to build instruction mnemonics:

“C” name	MIPS name	Size(bytes)	Assembler mnemonic
int	word	4	“w” as in <i>lw</i>
long	word	4	“w” as in <i>lw</i>
short	halfword	2	“h” as in <i>lh</i>
char	byte	1	“b” as in <i>lb</i>

### Integer data types

Byte and halfword loads come in two flavors:

- *Sign-extend*: *lb* and *lh* load the value into the least significant bits of the 32-bit register, but fill the high order bits by copying the “sign bit” (bit 7 of a byte, bit 16 of a half-word). This correctly converts a signed value to a 32-bit signed integer.
- *Zero-extend*: instructions *lbu* and *lhu* load the value into the least significant bits of a 32-bit register, with the high order bits filled with zero. This correctly converts an unsigned value in memory to the corresponding 32-bit unsigned integer value; so byte value 254 becomes 32-bit value 254.

If the byte-wide memory location whose address is in *t1* contains the value 0xFE (-2, or 254 if interpreted as unsigned), then:

```
lb    t2, 0(t1)
lbu   t3, 0(t1)
```

will leave *t2* holding the value 0xFFFF FFFE (-2 as signed 32-bit) and *t3* holding the value 0x0000 00FE (254 as signed or unsigned 32-bit).

Subtle differences in the way shorter integers are extended to longer ones are a historical cause of C portability problems, and the modern C standards have elaborate rules. On machines like the MIPS, which does not perform 8- or 16-bit precision arithmetic directly, expressions involving *short* or *char* variables are less efficient than word operations.

### Unaligned loads and stores

Normal loads and stores in the MIPS architecture must be aligned; half-words may be loaded only from 2-byte boundaries, and words only from 4-byte boundaries. A load instruction with an unaligned address will produce a trap. Because CISC architectures such as the MC680x0 and iAPXx86 do handle unaligned loads and stores, this could complicate porting software from one of these architectures. The MIPS architecture does provide mechanisms to support this type of operation; in extremity, software can provide a trap handler which will emulate the desired load operation and hide this feature from the application.

All data items declared by C code will be correctly aligned.

But when it is known in advance that the program will transfer a word from an address whose alignment is unknown and will be computed at run time, the architecture does allow for a special 2-instruction sequence (much more efficient than a series of byte loads, shifts and assembly). This sequence is normally generated by the macro-instruction *ulw* (unaligned load word).

(A macro-instruction *ulh*, unaligned load half, is also provided, and is synthesized by two loads, a shift, and a bitwise “or” operation.)

The special machine instructions are *lwl* and *lwr* (load word left, load word right). “Left” and “right” are arithmetical directions, as in “shift left”; “left” is movement towards more significant bits, “right” is towards less significant bits.

These instructions do three things:

- load 1, 2, 3 or 4 bytes from within one aligned 4-byte (word) location;
- shift that data to move the byte selected by the address to either the most-significant (*lwl*) or least-significant (*lwr*) end of a 32-bit field;
- merge the bytes fetched from memory with the data already in the destination.

This breaks most of the rules the architecture usually sticks by; it does a logical operation on a memory variable, for example. Special hardware allows the *lwl*, *lwr* pair to be used in consecutive instructions, even though the second instruction uses the value generated by the first.

For example, on a CPU configured as big-endian the assembler instruction:

```
ulw    t1, 0(t2)
add    t4, t3, t1
```

is implemented as:

```
lwl    t1, 0(t2)
lwr    t1, 3(t2)
nop
add    t4, t3, t1
```

Where:

- the *lwl* picks up the lowest-addressed byte of the unaligned 4-byte region, together with however many more bytes which fit into an aligned word. It then shifts them left, to form the most-significant bytes of the register value.
- the *lwr* is aimed at the highest-addressed byte in the unaligned 4-byte region. It loads it, together with any bytes which precede it in the same memory word, and shifts it right to get the least significant bits of the register value. The merge leaves the high-order bits unchanged.
- Although special hardware ensures that a *nop* is not required between the *lwl* and *lwr*, there is still a load delay between the second of them and a normal instruction.

Note that if *t2* was in fact 4-byte aligned, then both instructions load the entire word; duplicating effort, but achieving the desired effect.

CPU behavior when operating with little-endian byte order is described in a later chapter.

### Floating point data in memory

Loads into floating point registers from 4-byte aligned memory move data without any interpretation – a program can load an invalid floating point number and no FP error will result until an arithmetic operation is requested with it as an operand.

This allows a programmer to load single-precision values by a load into an even-numbered floating point register; but the programmer can also load a double-precision value by a macro instruction, so that:

```
ldc1   $f2, 24(t1)
```

is expanded to two loads to consecutive registers:

```
lwc1   $f2, 24(t1)
lwc1   $f3, 28(t1)
```

The C compiler aligns 8-byte long double-precision floating point variables to 8-byte boundaries. R30xx family hardware does not require this alignment; but it is done to avoid compatibility problems with implementations of MIPS-2 or MIPS-3 CPUs such as the IDT R4600 (Orion), where the *ldc1* instruction is part of the machine code, and the alignment is necessary.

## BASIC ADDRESS SPACE

The way in which MIPS processors use and handle addresses is subtly different from that of traditional CISC CPUs, and may appear confusing. Read the first part of this section carefully. Here are some guidelines:

- The addresses put into programs are rarely the same as the physical addresses which come out of the chip (sometimes they're close, but not the same). This manual will refer to them as *program addresses* and *physical addresses* respectively. A more common name for program addresses is "virtual addresses"; note that the use of the term "virtual address" does not necessarily imply that an operating system must perform virtual memory management (e.g. demand paging from disks...), but rather that the address undergoes some transformation before being presented to physical memory. Although virtual address is a proper term, this manual will typically use the term "program address" to avoid confusing virtual addresses with virtual memory management requirements.
- A MIPS-1 CPU has two operating modes: user and kernel. In user mode, any address above 2Gbytes (most-significant bit of the address set) is illegal and causes a trap. Also, some instructions cause a trap in user mode.
- The 32-bit program address space is divided into four big areas with traditional names; and different things happen according to the area an address lies in:

**kuseg** 0000 0000 - 7FFF FFFF (low 2Gbytes): these are the addresses permitted in user mode. In machines with an MMU ("E" versions of the R30xx family), they will always be translated (more about the R30xx MMU in a later chapter). Software should not attempt to use these addresses unless the MMU is set up.

For machines without an MMU ("base" versions of the R30xx family), the kuseg "program address" is transformed to a physical address by adding a 1GB offset; the address transformations for "base versions" of the R30xx family are described later in this chapter. Note, however, that many embedded applications do not use this address segment (those applications which do not require that the kernel and its resources be protected from user tasks).

**kseg0** 0x8000 0000 - 9FFF FFFF (512 Mbytes): these addresses are "translated" into physical addresses by merely stripping off the top bit, mapping them contiguously into the low 512 Mbytes of physical memory. This transformation operates the same for both "base" and "E" family members. This segment is referred to as "unmapped" because "E" version devices cannot redirect this translation to a different area of physical memory.

Addresses in this region are always accessed through the cache, so may not be used until the caches are properly initialized. They will be used for most programs and data in systems using "base" family members; and will be used for the OS kernel for systems which do use the MMU ("E" version devices).

**kseg1** 0xA000 0000 - BFFF FFFF (512 Mbytes): these addresses are mapped into physical addresses by stripping off the leading three bits, giving a duplicate mapping of the low 512 Mbytes of physical memory. However, kseg1 program address accesses will not use the cache.

The *kseg1* region is the only chunk of the memory map which is guaranteed to behave properly from system reset; that's why the after-reset starting point (0xBFC0 0000, commonly called the "reset exception vector") lies within it. The *physical* address of the starting point is 0x1FC0 0000 - which means that the hardware should place the boot ROM at this physical address.

Software will therefore use this region for the initial program ROM, and most systems also use it for I/O registers. In general, IO devices should always be mapped to addresses that are accessible from Kseg1, and system ROM is always mapped to contain the reset exception vector. Note that code in the ROM can then be accessed uncacheably (during boot up) using kseg1 program addresses, and also can be accessed cacheably (for normal operation) using kseg0 program addresses.

**kseg2** 0xC000 0000 - FFFF FFFF (1 Gbyte): this area is only accessible in kernel mode. As for kuseg, in "E" devices program addresses are translated by the MMU into physical addresses; thus, these addresses must not be referenced prior to MMU initialization. For "base versions", physical addresses are generated to be the same as program addresses for kseg2.

Note that many systems will not need this region. In "E" versions, it frequently contains OS structures such as page tables; simpler OS'es probably will have little need for kseg2.

## SUMMARY OF SYSTEM ADDRESSING

MIPS program addresses are rarely simply the same as physical addresses, but simple embedded software will probably use addresses in kseg0 and kseg1, where the program address is related in an obvious and unchangeable way to physical addresses.

Physical memory locations from 0x2000 0000 (512Mbyte) upward may be difficult to access. In "E" versions of the R30xx family, the only way to reach these addresses is through the MMU. In "base" family members, certain of these physical addresses can be reached using kseg2 or kuseg addresses: the address transformations for base R30xx family members is described later in this chapter.

## Kernel vs. user mode

In kernel mode (the CPU resets into this state), all program addresses are accessible.

In user mode:

- Program addresses above 2Gbytes (top bit set) are illegal and will cause a trap.

Note that if the CPU has an MMU, this means all valid user mode addresses must be translated by the MMU; thus, User mode for "E" devices typically requires the use of a memory-mapped OS.

For "base" CPUs, kuseg addresses are mapped to a distinct area of physical memory. Thus, kernel memory resources (including IO devices) can be made inaccessible to User mode software, without requiring a memory-mapping function from the OS. Alternately, the hardware can choose to "ignore" high-order address bits when performing address decoding, thus "condensing" kuseg, kseg2, kseg1, and kseg0 into the same physical memory.

- Instructions beyond the standard user set become illegal. Specifically, the kernel can prevent User mode software from accessing the on-chip CP0 (system control coprocessor, which controls exception and machine state and performs the memory management functions of the CPU).

Thus, the primary differences between User and Kernel modes are:

- User mode tasks can be inhibited from accessing kernel memory resources, including OS data structures and IO devices. This also means that various user tasks can be protected from each other.
- User mode tasks can be inhibited from modifying the basic machine state, by prohibiting accesses to CP0.

Note that the kernel/user mode bit does not change the interpretation of anything – just some things cease to be allowed in user mode. In kernel mode the CPU can access low addresses just as if it was in user mode, and they will be translated in the same way.

### Memory map for CPUs without MMU hardware

The treatment of *kseg0* and *kseg1* addresses is the same for all IDT R30xx CPUs. If the system can be implemented using only physical addresses in the low 512Mbytes, and system software can be written to use only *kseg0* and *kseg1*, then the choice of “base” vs. “E” versions of the R30xx family is not relevant.

For versions without the MMU (“base versions”), addresses in *kuseg* and *kseg2* will undergo a fixed address translation, and provide the system designer the option to provide additional memory.

The base members of the R30xx family provide the following address translations for *kuseg* and *kseg2* program addresses:

- *kuseg*: this region (the low 2Gbytes of program addresses) is translated to a contiguous 2Gbyte physical region between 1-3Gbytes. In effect, a 1GB offset is added to each *kuseg* program address. In hex:

Program address		Physical Address
0x0000 0000 -	→	0x4000 0000 -
0x7FFF FFFF		0xBFFF FFFF

- *kseg2*: these program addresses are genuinely untranslated. So program addresses from 0xC000 0000 - 0xFFFF FFFF emerge as identical physical addresses.

This means that “base” versions can generate most physical addresses (without the use of an MMU), except for a gap between 512Mbyte and 1Gbyte (0x2000 0000 through 0x3FFF FFFF). As noted above, many systems may ignore high-order address bits when performing address decoding, thus condensing all physical memory into the lowest 512MB addresses.

### Subsegments in the R3041 - memory width configuration

The R3041 CPU can be configured to access different regions of memory as either 32-, 16- or 8-bits wide. Where the program requests a 32-bit operation to a narrow memory (either with an uncached access, or a cache miss, or a store), the CPU may break a transaction into multiple data phases, to match the datum size to the memory port width.

The width configuration is applied independently to subsegments of the normal *kseg* regions, as follows:

- *kseg0* and *kseg1*: as usual, these are both mapped onto the low 512Mbytes. This common region is split into 8 subsegments (64Mbytes each), each of which can be programmed as 8-, 16- or 32-bits wide. The width assignment affects both *kseg0* and *kseg1* accesses (that is, one can view these as subsegments of the corresponding “physical” addresses).

- *kuseg*: is divided into four 512Mbyte subsegments, each independently programmable for width. Thus, *kuseg* can be broken into multiple portions, which may have varying widths. An example of this may be a 32-bit main memory with some 16-bit PCMCIA font cards and an 8-bit NVRAM.
- *kseg2*: is divided into two 512Mbyte subsegments, independently programmable for width. Again, this means that *kseg2* can support multiple memory subsystems, of varying port width.

Note that once the various memory port widths have been configured (typically at boot time), software does not have to be aware of the actual width of any memory system. It can choose to treat all memory as 32-bit wide, and the CPU will automatically adjust when an access is made to a narrower memory region. This simplifies software development, and also facilitates porting to various system implementations (which may or may not choose the same memory port widths).



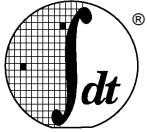

## **PROGRAMMER'S VIEW OF THE PROCESSOR ARCHITECTURE**

This chapter describes the assembly programmer's view of the CPU architecture, in terms of registers, instructions, and computational resources. This viewpoint corresponds, for example, to an assembly programmer writing user applications (although more typically, such a programmer would use a high-level language).

Information about kernel software development (such as handling interrupts, traps, and cache and memory management) are described in later chapters.

### **Registers**

There are 32 general purpose registers: \$0 to \$31. Two, and only two, are special to the hardware:

- \$0 always returns zero, no matter what software attempts to store to it.
- \$31 is used by the normal subroutine-calling instruction (*jal*) for the return address. Note that the call-by-register version (*jalr*) can use ANY register for the return address, though practice is to use only \$31.

In all other respects all registers are identical and can be used in any instruction (\$0 can be used as the destination of instructions; the value of \$0 will remain unchanged, however, so the instruction would be effectively a **NOP**).

In the MIPS architecture the “program counter” is not a register, and it is probably better to not think of it that way. The return address of a *jal* is two instructions later in sequence (the instruction after the jump delay slot instruction); the instruction after the call is the call's “delay slot” and is typically used to set up the last parameter.

There are no condition codes and nothing in the “status register” or other CPU internals is of any consequence to the user-level programmer.

There are two registers associated with the integer multiplier. These registers, referred to as “HI” and “LO”, contain the 64-bit product result of a multiply operation, or the quotient and remainder of a divide.

The floating point math co-processor (called *FPA* for floating point accelerator), if available, adds 32 floating point registers<sup>†</sup>; in simple assembler language they are just called \$0 to \$31 again – the fact that these are floating point registers is implicitly defined by the instruction. Actually, only the 16 even-numbered registers are usable for math; but they can be used for either single-precision (32 bit) or double-precision (64-bit) numbers. When performing double-precision arithmetic, odd numbered register \$N+1 holds the remaining bits of the even numbered register identified \$N. Only moves between integer and FPA, or FPA load/store instructions, ever refer to odd-numbered registers (and even then the assembler helps the programmer forget...)

---

<sup>†</sup> The FPA also has a different set of registers called “co-processor 1 registers” for control purposes. These are typically used to manage the actions/state of the FPA, and should not be confused with the FPA data registers.

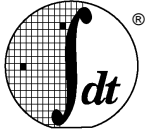

Integrated Device Technology, Inc.

## SYSTEM CONTROL CO-PROCESSOR ARCHITECTURE

## CHAPTER 3

This chapter concentrates on the aspects of the R30xx family architecture that must be managed by the OS programmer. Note that most of these features are transparent to the user program author; however, the nature of embedded systems is such that most embedded systems programmers will have a view of the underlying CPU and system architecture, and thus will find this material important.

### Co-processors

MIPS uses the term “co-processor” both in a traditional fashion, and also in a non-traditional fashion. Specifically, the FPA device is a traditional microprocessor co-processor: it is an optional part of the architecture, with its own particular instruction set.

Opcodes are reserved and instruction fields defined for up to four “co-processors”. Architecturally, the co-processors can be tightly coupled to the base integer CPU; for example, the ISA defines instructions to move data directly between memory and the coprocessor, rather than requiring it to be moved into the integer processor first.

However, MIPS also uses the term “co-processor” for the functions required to manage the CPU environment, including exception management, cache control, and memory management. This segmentation insures that the chip architecture can be varied (e.g. cache architecture, interrupt controller, etc.), without impacting user mode software compatibility.

These functions are grouped by MIPS into the on-chip “co-processor 0”, or “system control co-processor” - and these instructions implement the whole CPU control system. Note that co-processor 0 has no independent existence, and is certainly not optional. It provides a standard way of encoding the instructions which access the CPU status register; so that, although the definition of the status register changes among implementations, programmers can use the same assembler for both CPUs. Similarly, the exception and memory management strategies can be varied among implementations, and these effects isolated to particular portions of the OS kernel.

### CPU CONTROL SUMMARY

This chapter, coupled with chapters on cache management, memory management, and exception processing, provide details on managing the machine and OS state. The areas of interest include:

- *CPU control and co-processor*: how privileged instructions are organized, with shortform descriptions. There are relatively few privileged instructions; most of the low-level control over the CPU is exercised by reading and writing bit-fields within special registers.
- *Exceptions*: external interrupts, invalid operations, arithmetic errors - all result in “exceptions”, where control is transferred to an *exception handler* routine.

MIPS exceptions are extremely simple - the hardware does the absolute minimum, allowing the programmer to tailor the exception mechanism to the needs of the particular system.

A later chapter describes MIPS exceptions, why they are “precise”, exception vectors, and conventions about how to code exception handling routines.

Special problems can arise with *nested exceptions*: exceptions occurring while the CPU is still handling an earlier exception.

Hardware interrupts have their own style and rules.

The Exception Management chapter includes an annotated example of a moderately-complicated exception handler.

- *Caches and cache management*: all R30xx implementations have dual caches (the I-cache for instructions, the D-cache for data). On-chip hardware is provided to manage the caches, and the programmer working with I/O devices, particularly with DMA devices, may need to explicitly manage the caches in particular situations.

To manipulate the caches, the CPU allows software to *isolate* them, inhibiting cache/memory traffic and allowing the processor to access cache as if it were simple memory; and the CPU can *swap* the roles of the I-cache and D-cache (the only way to make the I-cache writable).

Caches must sometimes be cleared of stale or invalid/uninitialized data. Even following power-up, the R30xx caches are in a random state and must be cleaned up before they can be used. A later chapter will discuss the techniques used by software to manage the on-chip cache resources.

In addition, techniques to determine the on-chip cache sizes will be shown (greatest flexibility is achieved if software can be written to be independent of cache sizes).

For the diagnostics programmer, techniques to test the cache memory and probe for particular entries will be discussed.

On some CPU implementations the system designer may make configuration choices about the cache (e.g. the R3081 and R3071 allow the cache organization to be selected between 16kB of I-cache/4kB of D-cache and 8kB each of I- and D- cache). The cache management chapter will also discuss some of the considerations to apply to make a proper selection.

- *Write buffer*: on R30xx family CPUs the D-cache is always *write through*; all writes go to main memory as well as the cache. This simplifies the caches, but main memory won't be able to accept data as fast as the CPU can write it. Much of the performance loss can be made up by using a FIFO store which holds a number of "write cycles" (it stores both address and data). In the R30xx family, this FIFO, called the write buffer, is integrated on-chip.

System programmers may need to know that writes happen later than the code sequence suggests. The chapter on cache management discusses this.

- *Starting up*: at reset almost nothing is defined, so the software must build carefully. In MIPS CPUs, reset is implemented in almost exactly the same way as the exceptions.

A later chapter on reset initialization discusses ways of finding out which CPU is executing the software, and how to get a ROM program to run.

An example of a C runtime environment, attending to the stack and special registers, is provided.

- *Memory management and the TLB*: A later chapter will discuss address translation and managing the translation hardware (the TLB). This section is mostly for OS programmers.

## CPU CONTROL AND "CO-PROCESSOR 0"

### CPU control instructions

Most control functions are implemented with registers (most of which consist of multiple bitfields). The MIPS architecture has an escape mechanism to define instructions for "co-processors" – and the CPU control instructions are coded for "co-processor 0".

There are several CPU control instructions used in the memory management implementation, which are described in a later chapter. But leaving aside the MMU, CPU control defines just one instruction beyond the necessary move to and from the control registers.

**mtc0**      *rs, <nn>*      **-Move to co-processor zero**

Loads “co-processor 0” register number *nn* from CPU general register *rs*. It is unusual, and not good practice, to refer to CPU control registers by their number in assembler sources; normal practice is to use the names listed in Table 3.1, “Summary of CPU control registers (not MMU)”. In some tool-chains the names are defined by a C-style “include” file, and the C pre-processor run as a front-end to the assembler; the assembler manual should provide guidance on how to do this. This is the only way of setting bits in a CPU control register.

**mfc0**      *rd, <nn>*      **>-Move from co-processor zero**

General register *rd* is loaded with the values from CPU control register number *nn*. Once again, it is common to use a symbolic name and a macro-processor to save remembering the numbers. This is the only way of inspecting bits in a control register.

**rfe**      **-Restore from exception**

Note that this is not “return from exception”. This instruction restores the status register to go back to the state prior to the trap. To understand what it does, refer to the status register *SR* defined later in this chapter. The only secure way of returning to user mode from an exception is to return with a *jr* instruction which has the *rfe* in its delay slot.

### Standard CPU control registers

This table describes the general CPU control registers (ignoring the MMU control registers). Also note that typical convention is to reserve k0 and k1 for exception processing, although they are proper GP registers of the integer CPU unit.

Register Mnemonic	Description	CP0 reg no.
PRId	CP0 type and rev level	15
SR	(status register) CPU mode flags	12
Cause	Describes the most recently recognized exception	13
EPC	Return address from trap	14
BadVaddr	Contains the last invalid program address which caused a trap. It is set by address errors of all kinds, even if there is no MMU	8
Config	CPU configuration (R3081 and R3041 only)	3
BusCtrl	(R3041 only) configure bus interface signals. Needs to be setup to match the hardware implementation.	2
PortSize	(R3041 only) used to flag some program address regions as 8- or 16-bits wide. Must be programmed to match the hardware implementation.	10
Count	(R3041 only, read/write) a 24-bit counter incrementing with the CPU clock.	9
Compare	(R3041 only, read/write) a 24-bit value used to wraparound the <i>Count</i> value and set an output signal.	11

**Table 3.1. Summary of CPU control registers (not MMU)**

### Encoding of control registers

The next section describes the format of the control registers, with a sketch of the function of each field. In most cases, more information about how things work is to be found in separate sections or chapters later.

A note about reserved fields is in order here. Many unused control register fields are marked “0”. Bits in such fields are guaranteed to read zero, and should be written as zero. Other reserved fields are marked “reserved” or “x”; software must always write them as zero, and should not assume that it will get back zero or any other particular value.

Registers specific to the memory management system are described in a later chapter.

### PRId Register

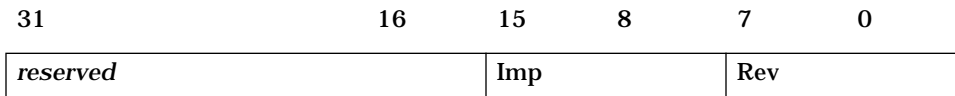

**Figure 3.1. PRId Register fields**

Figure 3.1, “PRId Register fields” shows the layout of the *PRId* register, a read-only register to be consulted to identify the CPU type (more properly, this register describes CP0, allowing the kernel to dynamically configure itself for various CPU implementations). “Imp” should be related to the CPU control register set. The encoding of Imp is described below:

CPU type	“Imp” value
R3000A (including R3051, R3052, R3071, and R3081)	3
IDT unique (R3041)	7

Note that when the Imp field indicates IDT unique, the revision number can be used to distinguish among various CP0 implementations. Refer to the R3041 User’s manual for the revision level appropriate for that device. Since the R3051, 52, 71, and 81 are kernel compatible with the R3000A, they share the same Imp value.

When printing the value of this register, it is conventional to print them out as “x.y” where “x” and “y” are the decimal values of Imp and Rev respectively. Try not to use this register and the CPU manuals to size things, or to establish the presence or absence of particular features; software will be more portable and robust if it is designed to include code sequences to probe for the existence of individual features. This manual will provide numerous examples designed to determine cache sizes, presence or absence of TLB, FPA, etc.

### SR Register

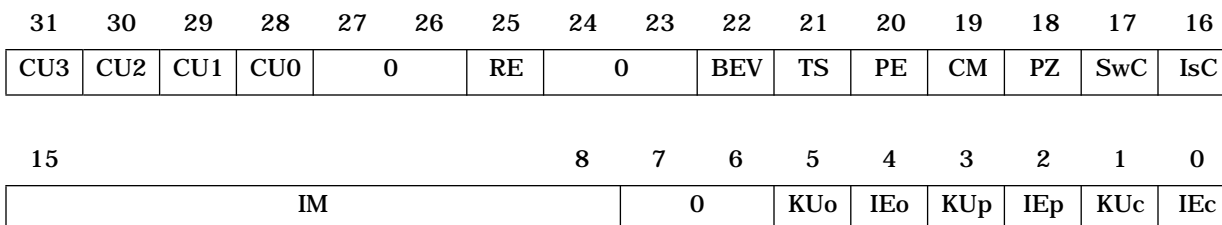

**Figure 3.2. Fields in status register (SR)**

The MIPS CPU has remarkably few mode bits; those that exist are defined by fields in the CPU status register *SR*, as shown in Figure 3.2, “Fields in status register (*SR*)”.

Note that there are no modes such as non-translated or non-cached in MIPS CPUs; all translation and caching decisions are made on the basis of the program address. Fields are:

CU3,

CU2 Bits (31:30) control the usability of “co-processors” 3 and 2 respectively. In the R30xx family, these might be enabled if software wishes to use the BrCond(3:2) input pins for polling, or to speed exception decoding.

CU1 “co-processor 1 usable”: 1 to use FPA if present, 0 to disable. When 0, all FPA instructions cause an exception, even for the kernel. It can be useful to turn off an FPA even when one is available; it may also be enabled in devices which do not include an FPA, if the intent is to use the BrCond(1) pin as a polled input.

CU0 “co-processor 0 usable”: set 1 to be able to use some nominally-privileged instructions in user mode (this is rarely if ever done). The CPU control instructions encoded as “co-processor 0” type are always usable in kernel mode, regardless of the setting of this bit.

RE “reverse endianness in user mode”. The MIPS processors can be configured, at reset time, with either “endianness” (byte ordering convention, discussed in the various CPU’s User’s Manuals and later in this manual). The RE bit allows binaries intended to be run with one byte ordering convention to be run in systems with the opposite convention, presuming OS software provided the necessary support.

When RE is active, user-privilege software runs as if the CPU had been configured with the opposite endianness.

However, achieving cross-universe running would require a large software effort as well, and should not be necessary in embedded systems.

BEV “boot exception vectors”: when BEV == 1, the CPU uses the ROM (kseg1) space exception entry point (described in a later chapter). BEV is usually set to zero in running systems; this relocates the exception vectors to RAM addresses, speeding accesses and allowing the use of “user supplied” exception service routines.

TS “TLB shutdown”: In devices which implement the full R3000A MMU, TS gets set if a program address simultaneously matches two TLB entries. Prolonged operation in this state, in some implementations, could cause internal contention and damage to the chip. TLB shutdown is terminal, and can be cleared only by a hardware reset.

In base family members, which do not include the TLB, this bit is set by reset; software can rely on this feature to determine the presence or absence of TLB support hardware.

PE set if a cache parity error has occurred. No exception is generated by this condition, which is really only useful for diagnostics. The MIPS architecture has cache diagnostic facilities because earlier versions of the CPU used external caches, and this provided a way to verify the timing of a particular system. For those implementations the cache parity error bit was an essential design debug tool.

For CPUs with on-chip caches this feature is rarely needed; only the R3071 and R3081 implement parity over the on-chip caches.

- CM shows the result of the last load operation performed with the D-cache isolated (described in the chapter on cache management). CM is set if the cache really contained data for the addressed memory location (i.e. if the load would have hit in the cache even if the cache had not been isolated).
- PZ When set, cache parity bits are written as zero and not checked. This was useful in old R3000A systems which required external cache RAMs, but is of little relevance to the R30xx family.
- SwC,
- IsC “swap caches” and “isolate (data) cache”. Cache mode bits for cache management and diagnostics; their use is described in detail in a later chapter on cache management. In simple terms:
- IsC set 1: makes all loads and stores access only the data cache, and never memory; and in this mode a partial-word store invalidates the cache entry. Note that when this bit is set, even uncached data accesses will not be seen on the bus; further, this bit is not initialized by reset. Boot-up software must insure this bit is properly initialized before relying on external data references.
  - SwC set 1: reverses the roles of the I-cache and D-cache, so that software can access and invalidate I-cache entries.
- IM “interrupt mask”: an 8 bit field defining which interrupt sources, when active, will be allowed to cause an exception. Six of the interrupt sources are external pins (one may be used by the FPA, which although it lives on the same chip is logically external); the other two are the software-writable interrupt bits in the *Cause* register.
- No interrupt prioritization is provided by the CPU: the hardware treats all interrupt bits the same. This is described in greater detail in the chapter dealing with exceptions.
- KUc,
- IEc The two basic CPU protection bits.
- KUc is set 1 when running with kernel privileges, 0 for user mode. In kernel mode, software can get at the whole program address space, and use privileged (“co-processor 0”) instructions. User mode restricts software to program addresses between 0x0000 0000 and 0x7FFF FFFF, and can be denied permission to run privileged instructions; attempts to break the rules result in an exception.
- IEc is set 0 to prevent the CPU taking any interrupt, 1 to enable.
- KUp, IEp “KU previous, IE previous”:
- on an exception, the hardware takes the values of KUc and IEc and saves them here; at the same time as changing the values of KUc, IEc to [1, 0] (kernel mode, interrupts disabled). The instruction *rfe* can be used to copy KUp, IEp back into KUc, IEc.
- KUo, IEo “KU old, IE old”:
- on an exception the KUp, IEp bits are saved here. Effectively, the six KU/IE bits are operated as a 3-deep, 2-bit wide stack which is pushed on an exception and popped by an *rfe*.
- This provides a chance of recovering cleanly from an exception occurring so early in an exception handling routine that the first exception has not yet saved *SR*. The circumstances in which this can be done are limited, and it is probably only really of use in allowing the user TLB refill code to be made a little shorter, as described in the chapter on memory management.

### Cause Register

31	30	29	28	27	16	15	8	7	6	2	1	0
BD	0	CE		0		IP		0	ExcCode		0	

**Figure 3.3. Fields in the Cause register**

Figure 3.3, “Fields in the Cause register” shows the fields in the *Cause* register, which are consulted to determine the kind of exception which happened and will be used to decide which exception routine to call.

**BD** “branch delay”: if set, this bit indicates that the EPC does not point to the actual “exception” instruction, but rather to the branch instruction which immediately precedes it.

When the exception restart point is an instruction which is in the “delay slot” following a branch, *EPC* has to point to the branch instruction; it is harmless to re-execute the branch, but if the CPU returned from the exception to the branch delay instruction itself the branch would not be taken and the exception would have broken the interrupted program.

The only time software might be sensitive to this bit is if it must analyze the “offending” instruction (if  $BD == 1$  then the instruction is at  $EPC + 4$ ). This would occur if the instruction needs to be emulated (e.g. a floating point instruction in a device with no hardware FPA; or a breakpoint placed in a branch delay slot).

**CE** “co-processor error”: if the exception is taken because a “co-processor” format instruction was for a “co-processor” which is not enabled by the *CUx* bit in *SR*, then this field has the co-processor number from that instruction.

**IP** “Interrupt Pending”: shows the interrupts which are currently asserted (but may be “masked” from actually signalling an exception). These bits follow the CPU inputs for the six hardware levels. Bits 9 and 8 are read/writable, and contain the value last written to them. However, any of the 8 bits active when enabled by the appropriate *IM* bit and the global interrupt enable flag *IEc* in *SR*, will cause an interrupt.

*IP* is subtly different from the rest of the *Cause* register fields; it doesn’t indicate what happened when the exception took place, but rather shows what is happening now.

**ExcCode**

A 5-bit code which indicates what kind of exception happened, as detailed in Table 3.2, “ExcCode values: different kinds of exceptions”.

ExcCode Value	Mnemonic	Description
0	Int	Interrupt
1	Mod	“TLB modification”
2	TLBL	“TLB load/TLB store”
3	TLBS	
4	AdEL	Address error (on load/I-fetch or store respectively). Either an attempt to access outside kuseg when in user mode, or an attempt to read a word or half-word at a misaligned address.
5	AdES	

**Table 3.2. ExcCode values: different kinds of exceptions**



ExcCode Value	Mnemonic	Description
6	IBE	Bus error (instruction fetch or data load, respectively). External hardware has signalled an error of some kind; proper exception handling is system-dependent. The R30xx family CPUs can't take a bus error on a store; the write buffer would make such an exception "imprecise".
7	DBE	
8	Syscall	Generated unconditionally by a <i>syscall</i> instruction.
9	Bp	Breakpoint - a <i>break</i> instruction.
10	RI	"reserved instruction"
11	CpU	"Co-Processor unusable"
12	Ov	"arithmetic overflow". Note that "unsigned" versions of instructions (e.g. <i>addu</i> ) never cause this exception.
13-31	-	reserved. Some are already defined for MIPS CPUs such as the R6000 and R4xxx

**Table 3.2. ExcCode values: different kinds of exceptions**

### EPC Register

This is a 32-bit register containing the 32-bit address of the return point for this exception. The instruction causing (or suffering) the exception is at EPC, unless BD is set in *Cause*, in which case EPC points to the previous (branch) instruction.

### BadVaddr Register

A 32-bit register containing the address whose reference led to an exception; set on any MMU-related exception, on an attempt by a user program to access addresses outside kuseg, or if an address is wrongly aligned for the datum size referenced.

After any other exception this register is undefined. Note in particular that it is not set after a bus error.

## R3041, R3071, and R3081 specific registers

### Count and Compare Registers (R3041 only)

Only present in the R3041, these provide a simple 24-bit counter/timer running at CPU cycle rate. *Count* counts up, and then wraps around to zero once it has reached the value in the *Compare* register. As it wraps around the **Tc\*** CPU output is asserted. According to CPU configuration (bit TC of the *BusCtrl* register), **Tc\*** will either remain active until reset by software (re-write *Compare*), or will pulse. In either case the counter just keeps counting. To generate an interrupt **Tc\*** must be connected to one of the interrupt inputs.

From reset *Compare* is setup to its maximum value (0xFF FFFF), so the counter runs up to  $2^{24}-1$  before wrapping around.

### Config Register (R3071 and R3081)

31	30	29	28	26	25	24	23	22	0
Lock	Slow Bus	DB Refill	FPInt		Halt	RF	AC		reserved

**Figure 3.4. Fields in the R3071/81 Config Register**

- *Lock*: set this bit to write to the register for the last time; all future writes to *Config* will be ignored. The intention is that initialization software will set the register and can then lock it in case some ill-behaved piece of software developed on some earlier version of the MIPS architecture tries to stomp on *Config*; this would have had no effect on earlier CPUs.
- *Slow Bus*: hardware may require that this bit be set. It only matters when the CPU performs a store while running from a cached location. The system hardware design determines the proper setting for this bit; setting it to ‘1’ should be permissible for any system, but loses some performance in memory systems able to support more aggressive bus performance.

If set 1, an idle bus cycle is guaranteed between any read and write transfer. This enables additional time for bus tri-stating, control logic generation, etc.

- *DB*: “data cache block refill”, set 1 to reload 4 words into the data cache on any miss, set 0 to reload just one word. Can be initialized either way on the R3081, by a reset-time hardware input.
- *FPInt*: controls the CPU interrupt level on which FPA interrupts are reported. On original R3000 CPUs the FPA was external and this was determined by wiring; but the R3081’s FPA is on the chip and it would be inefficient (and jeopardize pin-compatibility) to send the interrupt off chip and on again.

Set *FPInt* to the binary value of the CPU interrupt pin number which is dedicated to FPA interrupts. By default the field is initialized to “011” to select the pin *Int3*†; MIPS convention put the FPA on external interrupt pin 3. For whichever pin is dedicated to the FPA, the CPU will then ignore the value on the external pin; the IP field of the cause register will simply follow the FPA.

On the R3071, this field is “reserved”, and must be written as “000”.

- *Halt*: set to bring the CPU to a standstill. It will start again as soon as any interrupt input is asserted (regardless of the state of the interrupt mask). This is useful for power reduction, and can also be used to emulate old MC68000 “Halt” operation.
- *RF*: slows the CPU to 1/16th of the normal clock rate, to reduce power consumption. Illegal unless the CPU is running at 33Mhz or higher. Note that the CPUs output clock (which is normally used to synchronize all the interface logic) slows down too; the hardware design should also accommodate this feature if software desires to use it.
- *AC*: “alternate cache”. 0 for 16K I-cache/4K D-cache, but set 1 for 8K I-cache/8K D-cache.
- *Reserved*: must only be written as zero. It will probably read as zero, but software should not rely on this.

**Config Register (R3041)**

31	30	29	28		20	19	18		0
Lock	1	DBR	0		FDM	0			

**Figure 3.5. Fields in the R3041 Config (Cache Configuration) Register**

† Take care: the external pin *Int3* corresponds to the bit numbered “5” in IP of the Cause register or IM of the SR register. That’s because both the Cause and SR fields support two “software interrupts” numbered as bits 0 and 1.

- *Lock*: set 1 to finally configure register (additional writes will not have any effect until the CPU is reset).
- 1 and 0: set fields to exactly the value shown.
- *DBR*: “DBlockRefill”, set 1 to read 4 words into the cache on a miss, 0 to refill just the word missed on. The proper setting for a given system is dependent on a number of factors, and may best be determined by measuring performance in each mode and selecting the best one. Note that it is possible for software to dynamically reconfigure the refill algorithm depending on the current code executing, presuming the register has not been “locked”.
- *FDM*: “Force D-Cache Miss”, set 1 for an R3041-specific cache mode, where all loads result in data being fetched from memory (missing in the data cache), but the incoming data is still used to refill the cache. Stores continue to write the cache. This is useful when software desires to obtain the high-bandwidth of the cache and cache refills, but the corresponding main memory is “volatile” (e.g. a FIFO, or updated by DMA).

### BusCtrl Register (R3041 only)

The R3041 CPU has many hardware interface options not available on other members of the R30xx family, which are intended to allow the use of simpler and cheaper interface and memory components. The *BusCtrl* register does most of the configuration work. It needs to be set strictly in accordance with the needs of the hardware implementation. Note also that its default settings (from reset) leave the interface compatible with other R30xx family members.

Figure 3.6, “Fields in the R3041 Bus Control (BusCtrl) Register” shows the layout of the fields, and their uses are provided for completeness.

```

31  3  2  2  2  2  2  2  2  21  2  1  1  1  1  1  13  1  1  1  0
    0  8  7  6  5  4  3  2      0  9  8  6  5  4      2  1  0

```

Loc k	10	Mem	ED	IO	BE 16	1	B E	11	BTA	DM A	T C	B R	0x30 0
----------	----	-----	----	----	----------	---	--------	----	-----	---------	--------	--------	-----------

**Figure 3.6. Fields in the R3041 Bus Control (BusCtrl) Register**

- *Lock*: when software has initialized *BusCtrl* to its desired state it may write this bit to prevent its contents being changed again until the system is reset.
- 10 and other numbers: write exactly the specified bit pattern to this field (hex used for big ones, but others are given as binary). Improper values may cause test modes and other unexpected side effects.
- *Mem*: “**MemStrobe\*** control”. Set this field to *xy* binary, where *x* set means the strobe activates on reads, and *y* set makes it active on writes.
- *ED*: “**ExtDataEn\*** control”. Encoded as for “Mem”. Note that the BR bit must be zero for this pin to function as an output.
- *IO*: “**IOStrobe\*** control”. Encoded as for “Mem”. Note that the BR bit must be zero for this pin to function as an output.
- *BE16*: “**BE16(1:0)\*** read control” – 0 to make these pins active on write cycles only.
- *BE*: “**BE(3:0)\*** read control” – 0 to make these pins active on write cycles only.
- *BTA*: “Bus turn around time”. Program with a binary number between 0 and 3, for 0-3 cycles of guaranteed delay between the end of a read cycle and the start of the address phase of the next cycle. This field enables the use of devices with slow tri-state time, and enables the system designer to save cost by omitting data transceivers.

- *DMA*: “DMA Protocol Control”, enables “DMA pulse protocol”. When set, the CPU uses its DMA control pins to communicate its desire for the bus even while a DMA is in progress.
- *TC*: “**TC\*** negation control”. **TC\*** is the output pin which is activated when the internal timer register *Count* reaches the value stored in *Compare*. Set *TC* zero to make the **TC\*** pin just pulse for a couple of clock periods; leave *TC* as 1, and **TC\*** will be asserted on a compare and remain asserted until software explicitly clears it (by re-writing *Compare* with any value).  
If **TC\*** is used to generate a timer interrupt, then use the default (*TC* == 0). The pulse is more useful when the output is being used by external logic (e.g. to signal a DRAM refresh).
- *BR*: “**SBrCond(3:2)** control”. Set zero to recycle the **SBrCond(3:2)** pins as **IOStrobe** and **ExtDataEn** respectively.

### PortSize Register (R3041 only)

The *PortSize* register is used to flag different parts of the program address space for accesses to 8-, 16- or 32-bit wide memory.

Settings of this register have to be made at a time and to values which will be mandated by the hardware design. See “IDT79R3041 Hardware User’s Manual” for details.

### What registers are relevant when?

The various CP0 registers and their fields provide support at specific times during system operation.

- *After hardware reset*: software must initialize *SR* to get the CPU into the right state to bootstrap itself.
- *Hardware configuration at start-up*: an R3041, R3071, or R3081 require initialization of *Config*, *BusCtrl*, and/or *PortSize* before very much will work. The system hardware implementation will dictate the proper configuration of these registers.
- *After any exception*: any MIPS exception (apart from one particular MMU event) invokes a single common “general exception handler” routine, at a fixed address.

On entry, no program registers are saved, only the return address in *EPC*. The MIPS hardware knows nothing about stacks. In any case the exception routine cannot use the user-mode stack for any purpose; the exception might have been a TLB miss on stack memory.

Exception software will need to use at least one of *k0* and *k1* to point to some “safe” (exception-proof) memory space. Key information can be saved, using the other *k0* or *k1* register to stage data from control registers where necessary.

Consult the *Cause* register to find out what kind of exception it was and dispatch accordingly.

- *Returning from exception*: control must eventually be returned to the value stored in *EPC* on entry.

Whatever kind of exception it was, software will have to adjust *SR* back upon return from exception. The special instruction *rfe* does the job; but note that it does not transfer control. To make the jump back software must load the original *EPC* value back into a general-purpose register and use a *jr* operation.

- *Interrupts*: *SR* is used to adjust the interrupt masks, to determine which (if any) interrupts will be allowed “higher priority” than the current one. The hardware offers no interrupt prioritization, but the software can do whatever it likes.
- *Instructions which always cause exceptions*: are often used (for system calls, breakpoints, and to emulate some kinds of instruction). These sometimes requires partial decoding of the offending

instruction, which can usually be found at the location *EPC*. But there is a complication; suppose that an exception occurs just after a branch but in time to prevent the branch delay slot instruction from running. Then *EPC* will point to the branch instruction (resuming execution starting at the delay slot would cause the branch to be ignored), and the BD bit will be set.

This *Cause* register bit flags this event; to find the instruction at which the exception occurred, add 4 to the *EPC* value when the BD bit is set.

- *Cache management routines*: *SR* contains bits defining special modes for cache management. In particular they allow software to *isolate* the data cache, and to *swap* the roles of the instruction and data caches.

The subsequent chapters will describe appropriate treatment of these registers, and provide software examples of their use.

## Conventional names and uses of general-purpose registers

Although the hardware makes few rules about the use of registers, their practical use is governed by a number of conventions. These conventions allow inter-changeability of tools, operating systems, and library modules. It is strongly recommended that these conventions be followed.

Reg No	Name	Used for
0	zero	Always returns 0
1	at	(assembler temporary) Reserved for use by assembler
2-3	v0-v1	Value (except FP) returned by subroutine
4-7	a0-a3	(arguments) First four parameters for a subroutine
8-15	t0-t7	(temporaries) subroutines may use without saving
24-25	t8-t9	
16-23	s0-s7	Subroutine “register variables”; a subroutine which will write one of these must save the old value and restore it before it exits, so the <i>calling</i> routine sees their values preserved.
26-27	k0-k1	Reserved for use by interrupt/trap handler - may change under your feet
28	gp	global pointer - some runtime systems maintain this to give easy access to (some) “static” or “extern” variables.
29	sp	stack pointer
30	s8/fp	9th register variable. Subroutines which need one can use this as a “frame pointer”.
31	ra	Return address for subroutine

**Table 2.1. Conventional names of registers with usage mnemonics**

With the conventional uses of the registers go a set of conventional names. Given the need to fit in with the conventions, use of the conventional names is pretty much mandatory. The common names are described in Table 2.1, “Conventional names of registers with usage mnemonics”.

### Notes on conventional register names

- *at*: this register is reserved for use inside the synthetic instructions generated by the assembler. If the programmer must use it explicitly the directive *.noat* stops the assembler from using it, but then there are some things the assembler won't be able to do.
- *v0-v1*: used when returning non-floating-point values from a subroutine. To return anything bigger than  $2 \times 32$  bits, memory must be used (described in a later chapter).
- *a0-a3*: used to pass the first four non-FP parameters to a subroutine. That's an occasionally-false oversimplification; the actual convention is fully described in a later chapter.
- *t0-t9*: by convention, subroutines may use these values without preserving them. This makes them easy to use as “temporaries” when evaluating expressions – but a caller must remember that they may be destroyed by a subroutine call.
- *s0-s8*: by convention, subroutines must guarantee that the values of these registers on exit are the same as they were on entry – either by not using them, or by saving them on the stack and restoring before exit.

This makes them eminently suitable for use as “register variables” or for storing any value which must be preserved over a subroutine call.

- *k0-k1*: reserved for use by the trap/interrupt routines, which will not restore their original value; so they are of little use to anyone else.
- *gp*: (global pointer). If present, it will point to a load-time-determined location in the midst of your static data. This means that loads and stores to data lying within 32Kbytes either side of the *gp* value can be performed in a single instruction using *gp* as the base register.

Without the global pointer, loading data from a static memory area takes two instructions: one to load the most significant bits of the 32-bit constant address computed by the compiler and loader, and one to do the data load.

To use *gp* a compiler must know at compile time that a datum will end up linked within a 64Kbyte range of memory locations. In practice it can't know, only guess. The usual practice is to put "small" global data items in the area pointed to by *gp*, and to get the linker to complain if it still gets too big. The definition of what is "small" can typically be specified with a compiler switch (most compilers use "-G"). The most common default size is 8 bytes or less.

Not all compilation systems or OS loaders support *gp*.

- *sp*: (stack pointer). Since it takes explicit instructions to raise and lower the stack pointer, it is generally done only on subroutine entry and exit; and it is the responsibility of the subroutine being called to do this. *sp* is normally adjusted, on entry, to the lowest point that the stack will need to reach at any point in the subroutine. Now the compiler can access stack variables by a constant offset from *sp*. Stack usage conventions are explained in a later chapter.
- *fp*: (also known as *s8*). A subroutine will use a "frame pointer" to keep track of the stack if it wants to use operations which involve extending the stack by an amount which is determined at run-time. Some languages may do this explicitly; assembler programmers are always welcome to experiment; and (for many toolchains) C programs which use the "alloca" library routine will find themselves doing so.

In this case it is not possible to access stack variables from *sp*, so *fp* is initialized by the function prologue to a constant position relative to the function's stack frame. Note that a "frame pointer" subroutine may call or be called by subroutines which do not use the frame pointer; so long as the functions it calls preserve the value of *fp* (as they should) this is OK.

- *ra*: (return address). On entry to any subroutine, *ra* holds the address to which control should be returned – so a subroutine typically ends with the instruction "jr *ra*".

Subroutines which themselves call subroutines must first save *ra*, usually on the stack.

### Integer multiply unit and registers

MIPS' architects decided that integer multiplication was important enough to deserve a hard-wired instruction. This is not so common in RISCs, which might instead:

- implement a "multiply step" which fits in the standard integer execution pipeline, and require software routines for every multiplication (e.g. Sparc or AM29000); or
- perform integer multiplication in the floating point unit – a good solution but which compromises the optional nature of the MIPS floating point "co-processor".

The multiply unit consumes a small amount of die area, but dramatically improves performance (and cache performance) over "multiply step" operations. It's basic operation is to multiply two 32-bit values together to produce a 64-bit result, which is stored in two 32-bit

registers (called “hi” and “lo”) which are private to the multiply unit. Instructions *mfhi*, *mflo* are defined to copy the result out into general registers.

Unlike results for integer operations, the multiply result registers are *interlocked*. An attempt to read out the results before the multiplication is complete results in the CPU being stopped until the operation completes.

The integer multiply unit will also perform an integer division between values in two general-purpose registers; in this case the “lo” register stores the quotient, and the “hi” register the remainder.

In the R30xx family, multiply operations take 12 clocks and division takes 35. The assembler has a synthetic multiply operation which starts the multiply and then retrieves the result into an ordinary register. Note that MIPS Corp.’s assembler may even substitute a series of shifts and adds for multiplication by a constant, to improve execution speed.

Multiply/divide results are written into “hi” and “lo” as soon as they are available; the effect is not deferred until the writeback pipeline stage, as with writes to general purpose (GP) registers. If a *mfhi* or *mflo* instruction is interrupted by some kind of exception before it reaches the writeback stage of the pipeline, it will be aborted with the intention of restarting it. However, a subsequent multiply instruction which has passed the ALU stage will continue (in parallel with exception processing) and would overwrite the “hi” and “lo” register values, so that the re-execution of the *mfhi* would get wrong (i.e. new) data. For this reason it is recommended that a multiply should not be started within two instructions of an *mfhi*/*mflo*. The assembler will avoid doing this where it can.

Integer multiply and divide operations never produce an exception, though divide by zero produces an undefined result. Compilers will often generate code to trap on errors, particularly on divide by zero. Frequently, this instruction sequence is placed after the divide is initiated, to allow it to execute concurrently with the divide (and avoid a performance loss).

Instructions *mthi*, *mtlo* are defined to setup the internal registers from general-purpose registers. They are essential to restore the values of “hi” and “lo” when returning from an exception, but probably not for anything else.

## Instruction types

A full list of R30xx family integer instructions is presented in Appendix A. Floating point instructions are listed in Appendix B of this manual. Currently, floating point instructions are only available in the R3081, and are described in the R3081 User’s Manual.

The MIPS-1 ISA uses only three basic instruction encoding formats; this is one of the keys to the high-frequencies attained by RISC architectures.

Instructions are mostly in numerical order; to simplify reading, the list is occasionally re-ordered for clarity.

Throughout this manual, the description of various instructions will also refer to various subfields of the instruction. In general, the following typical nomenclature is used:

- op     The basic op-code, which is 6 bits long. Instructions which large sub-fields (for example, large immediate values, such as required for the “long” *j/jal* instructions, or arithmetic with a 16-bit constant) have a unique “op” field. Other instructions are classified in groups sharing an “op” value, distinguished by other fields (“op2” etc.).
- rs, rs1,     One or two fields identifying source registers.
- rs2
- rd     The register to be changed by this instruction.
- sa     Shift-amount: How far to shift, used in shift-by-constant instructions.



- op2** Sub-code field used for the 3-register arithmetic/logical group of instructions (*op* value of zero).
- offset** 16-bit signed *word* offset defining the destination of a “PC-relative” branch. The branch target will be the instruction “offset” words away from the “delay slot” instruction *after* the branch; so a branch-to-self has an offset of -1.
- target** 26-bit *word* address to be jumped to (it corresponds to a 28-bit byte address, which is always word-aligned). The long *j* instruction is rarely used, so this format is pretty much exclusively for function calls (*jal*).

The high-order 4 bits of the target address can't be specified by this instruction, and are taken from the address of the jump instruction. This means that these instructions can reach anywhere in the 256Mbyte region around the instructions' location. To jump further use a *jr* (jump register) instruction.

- constant** 16-bit integer constant for “immediate” arithmetic or logic operations.
- mf** Yet another extended opcode field, this time used by “co-processor” type instructions.
- rg** Field which may hold a source or destination register.
- crg** Field to hold the number of a CPU control register (different from the integer register file). Called “crs”/“crd” in contexts where it must be a source/destination respectively.

The instruction encodings have been chosen to facilitate the design of a high-frequency CPU. Specifically:

- The instruction encodings do reveal portions of the internal CPU design. Although there are variable encodings, those fields which are required very early in the pipeline are encoded in a very regular way:
- *Source registers are always in the same place*: so that the CPU can fetch two instructions from the integer register file without any conditional decoding. Some instructions may not need both registers – but since the register file is designed to provide two source values on every clock nothing has been lost.
- *16-bit constant is always in the same place*: permitting the appropriate instruction bits to be fed directly into the ALU's input multiplexer, without conditional shifts.

### Loading and storing: addressing modes

As mentioned above, there is only one basic “addressing mode”. Any load or store machine instruction can be written as:

```
operation dest-reg, offset(src-reg)
e.g.:lw $1, offset($2); sw $3, offset($4)
```

Any of the GP registers can be used for the destination and source. The *offset* is a signed, 16-bit number (so can be anywhere between -32768 and 32767); the program address used for the load is the sum of *dest-reg* and the *offset*. This address mode is normally enough to pick out a particular member of a C structure (“offset” being the distance between the start of the structure and the member required); it implements an array indexed by a constant; it is enough to reference function variables from the stack or frame pointer; to provide a reasonable sized global area around the *gp* value for static and extern variables.

The assembler provides the semblance of a simple direct addressing mode, to load the values of memory variables whose address can be computed at link time.

More complex modes such as double-register or scaled index must be implemented with sequences of instructions.

### Data types in Memory and registers

The R30xx family CPUs can load or store between 1 and 4 bytes in a single operation. Naming conventions are used in the documentation and to build instruction mnemonics:

“C” name	MIPS name	Size(bytes)	Assembler mnemonic
int	word	4	“w” as in <i>lw</i>
long	word	4	“w” as in <i>lw</i>
short	halfword	2	“h” as in <i>lh</i>
char	byte	1	“b” as in <i>lb</i>

### Integer data types

Byte and halfword loads come in two flavors:

- *Sign-extend*: *lb* and *lh* load the value into the least significant bits of the 32-bit register, but fill the high order bits by copying the “sign bit” (bit 7 of a byte, bit 16 of a half-word). This correctly converts a signed value to a 32-bit signed integer.
- *Zero-extend*: instructions *lbu* and *lhu* load the value into the least significant bits of a 32-bit register, with the high order bits filled with zero. This correctly converts an unsigned value in memory to the corresponding 32-bit unsigned integer value; so byte value 254 becomes 32-bit value 254.

If the byte-wide memory location whose address is in *t1* contains the value 0xFE (-2, or 254 if interpreted as unsigned), then:

```
lb    t2, 0(t1)
lbu   t3, 0(t1)
```

will leave *t2* holding the value 0xFFFF FFFE (-2 as signed 32-bit) and *t3* holding the value 0x0000 00FE (254 as signed or unsigned 32-bit).

Subtle differences in the way shorter integers are extended to longer ones are a historical cause of C portability problems, and the modern C standards have elaborate rules. On machines like the MIPS, which does not perform 8- or 16-bit precision arithmetic directly, expressions involving *short* or *char* variables are less efficient than word operations.

### Unaligned loads and stores

Normal loads and stores in the MIPS architecture must be aligned; half-words may be loaded only from 2-byte boundaries, and words only from 4-byte boundaries. A load instruction with an unaligned address will produce a trap. Because CISC architectures such as the MC680x0 and iAPX86 do handle unaligned loads and stores, this could complicate porting software from one of these architectures. The MIPS architecture does provide mechanisms to support this type of operation; in extremity, software can provide a trap handler which will emulate the desired load operation and hide this feature from the application.

All data items declared by C code will be correctly aligned.

But when it is known in advance that the program will transfer a word from an address whose alignment is unknown and will be computed at run time, the architecture does allow for a special 2-instruction sequence (much more efficient than a series of byte loads, shifts and assembly). This sequence is normally generated by the macro-instruction *ulw* (unaligned load word).

(A macro-instruction *ulh*, unaligned load half, is also provided, and is synthesized by two loads, a shift, and a bitwise “or” operation.)

The special machine instructions are *lwl* and *lwr* (load word left, load word right). “Left” and “right” are arithmetical directions, as in “shift left”; “left” is movement towards more significant bits, “right” is towards less significant bits.

These instructions do three things:

- load 1, 2, 3 or 4 bytes from within one aligned 4-byte (word) location;
- shift that data to move the byte selected by the address to either the most-significant (*lwl*) or least-significant (*lwr*) end of a 32-bit field;
- merge the bytes fetched from memory with the data already in the destination.

This breaks most of the rules the architecture usually sticks by; it does a logical operation on a memory variable, for example. Special hardware allows the *lwl*, *lwr* pair to be used in consecutive instructions, even though the second instruction uses the value generated by the first.

For example, on a CPU configured as big-endian the assembler instruction:

```
ulw    t1, 0(t2)
add    t4, t3, t1
```

is implemented as:

```
lwl    t1, 0(t2)
lwr    t1, 3(t2)
nop
add    t4, t3, t1
```

Where:

- the *lwl* picks up the lowest-addressed byte of the unaligned 4-byte region, together with however many more bytes which fit into an aligned word. It then shifts them left, to form the most-significant bytes of the register value.
- the *lwr* is aimed at the highest-addressed byte in the unaligned 4-byte region. It loads it, together with any bytes which precede it in the same memory word, and shifts it right to get the least significant bits of the register value. The merge leaves the high-order bits unchanged.
- Although special hardware ensures that a *nop* is not required between the *lwl* and *lwr*, there is still a load delay between the second of them and a normal instruction.

Note that if *t2* was in fact 4-byte aligned, then both instructions load the entire word; duplicating effort, but achieving the desired effect.

CPU behavior when operating with little-endian byte order is described in a later chapter.

### Floating point data in memory

Loads into floating point registers from 4-byte aligned memory move data without any interpretation – a program can load an invalid floating point number and no FP error will result until an arithmetic operation is requested with it as an operand.

This allows a programmer to load single-precision values by a load into an even-numbered floating point register; but the programmer can also load a double-precision value by a macro instruction, so that:

```
ldc1   $f2, 24(t1)
```

is expanded to two loads to consecutive registers:

```
lwc1   $f2, 24(t1)
lwc1   $f3, 28(t1)
```

The C compiler aligns 8-byte long double-precision floating point variables to 8-byte boundaries. R30xx family hardware does not require this alignment; but it is done to avoid compatibility problems with implementations of MIPS-2 or MIPS-3 CPUs such as the IDT R4600 (Orion), where the *ldc1* instruction is part of the machine code, and the alignment is necessary.

## BASIC ADDRESS SPACE

The way in which MIPS processors use and handle addresses is subtly different from that of traditional CISC CPUs, and may appear confusing. Read the first part of this section carefully. Here are some guidelines:

- The addresses put into programs are rarely the same as the physical addresses which come out of the chip (sometimes they're close, but not the same). This manual will refer to them as *program addresses* and *physical addresses* respectively. A more common name for program addresses is "virtual addresses"; note that the use of the term "virtual address" does not necessarily imply that an operating system must perform virtual memory management (e.g. demand paging from disks...), but rather that the address undergoes some transformation before being presented to physical memory. Although virtual address is a proper term, this manual will typically use the term "program address" to avoid confusing virtual addresses with virtual memory management requirements.
- A MIPS-1 CPU has two operating modes: user and kernel. In user mode, any address above 2Gbytes (most-significant bit of the address set) is illegal and causes a trap. Also, some instructions cause a trap in user mode.
- The 32-bit program address space is divided into four big areas with traditional names; and different things happen according to the area an address lies in:

**kuseg** 0000 0000 - 7FFF FFFF (low 2Gbytes): these are the addresses permitted in user mode. In machines with an MMU ("E" versions of the R30xx family), they will always be translated (more about the R30xx MMU in a later chapter). Software should not attempt to use these addresses unless the MMU is set up.

For machines without an MMU ("base" versions of the R30xx family), the kuseg "program address" is transformed to a physical address by adding a 1GB offset; the address transformations for "base versions" of the R30xx family are described later in this chapter. Note, however, that many embedded applications do not use this address segment (those applications which do not require that the kernel and its resources be protected from user tasks).

**kseg0** 0x8000 0000 - 9FFF FFFF (512 Mbytes): these addresses are "translated" into physical addresses by merely stripping off the top bit, mapping them contiguously into the low 512 Mbytes of physical memory. This transformation operates the same for both "base" and "E" family members. This segment is referred to as "unmapped" because "E" version devices cannot redirect this translation to a different area of physical memory.

Addresses in this region are always accessed through the cache, so may not be used until the caches are properly initialized. They will be used for most programs and data in systems using "base" family members; and will be used for the OS kernel for systems which do use the MMU ("E" version devices).

**kseg1** 0xA000 0000 - BFFF FFFF (512 Mbytes): these addresses are mapped into physical addresses by stripping off the leading three bits, giving a duplicate mapping of the low 512 Mbytes of physical memory. However, kseg1 program address accesses will not use the cache.

The *kseg1* region is the only chunk of the memory map which is guaranteed to behave properly from system reset; that's why the after-reset starting point (0xBFC0 0000, commonly called the "reset exception vector") lies within it. The *physical* address of the starting point is 0x1FC0 0000 - which means that the hardware should place the boot ROM at this physical address.

Software will therefore use this region for the initial program ROM, and most systems also use it for I/O registers. In general, IO devices should always be mapped to addresses that are accessible from Kseg1, and system ROM is always mapped to contain the reset exception vector. Note that code in the ROM can then be accessed uncacheably (during boot up) using kseg1 program addresses, and also can be accessed cacheably (for normal operation) using kseg0 program addresses.

**kseg2** 0xC000 0000 - FFFF FFFF (1 Gbyte): this area is only accessible in kernel mode. As for kuseg, in "E" devices program addresses are translated by the MMU into physical addresses; thus, these addresses must not be referenced prior to MMU initialization. For "base versions", physical addresses are generated to be the same as program addresses for kseg2.

Note that many systems will not need this region. In "E" versions, it frequently contains OS structures such as page tables; simpler OS'es probably will have little need for kseg2.

## SUMMARY OF SYSTEM ADDRESSING

MIPS program addresses are rarely simply the same as physical addresses, but simple embedded software will probably use addresses in kseg0 and kseg1, where the program address is related in an obvious and unchangeable way to physical addresses.

Physical memory locations from 0x2000 0000 (512Mbyte) upward may be difficult to access. In "E" versions of the R30xx family, the only way to reach these addresses is through the MMU. In "base" family members, certain of these physical addresses can be reached using kseg2 or kuseg addresses: the address transformations for base R30xx family members is described later in this chapter.

## Kernel vs. user mode

In kernel mode (the CPU resets into this state), all program addresses are accessible.

In user mode:

- Program addresses above 2Gbytes (top bit set) are illegal and will cause a trap.

Note that if the CPU has an MMU, this means all valid user mode addresses must be translated by the MMU; thus, User mode for "E" devices typically requires the use of a memory-mapped OS.

For "base" CPUs, kuseg addresses are mapped to a distinct area of physical memory. Thus, kernel memory resources (including IO devices) can be made inaccessible to User mode software, without requiring a memory-mapping function from the OS. Alternately, the hardware can choose to "ignore" high-order address bits when performing address decoding, thus "condensing" kuseg, kseg2, kseg1, and kseg0 into the same physical memory.

- Instructions beyond the standard user set become illegal. Specifically, the kernel can prevent User mode software from accessing the on-chip CP0 (system control coprocessor, which controls exception and machine state and performs the memory management functions of the CPU).

Thus, the primary differences between User and Kernel modes are:

- User mode tasks can be inhibited from accessing kernel memory resources, including OS data structures and IO devices. This also means that various user tasks can be protected from each other.
- User mode tasks can be inhibited from modifying the basic machine state, by prohibiting accesses to CP0.

Note that the kernel/user mode bit does not change the interpretation of anything – just some things cease to be allowed in user mode. In kernel mode the CPU can access low addresses just as if it was in user mode, and they will be translated in the same way.

### Memory map for CPUs without MMU hardware

The treatment of *kseg0* and *kseg1* addresses is the same for all IDT R30xx CPUs. If the system can be implemented using only physical addresses in the low 512Mbytes, and system software can be written to use only *kseg0* and *kseg1*, then the choice of “base” vs. “E” versions of the R30xx family is not relevant.

For versions without the MMU (“base versions”), addresses in *kuseg* and *kseg2* will undergo a fixed address translation, and provide the system designer the option to provide additional memory.

The base members of the R30xx family provide the following address translations for *kuseg* and *kseg2* program addresses:

- *kuseg*: this region (the low 2Gbytes of program addresses) is translated to a contiguous 2Gbyte physical region between 1-3Gbytes. In effect, a 1GB offset is added to each *kuseg* program address. In hex:

Program address		Physical Address
0x0000 0000 -	→	0x4000 0000 -
0x7FFF FFFF		0xBFFF FFFF

- *kseg2*: these program addresses are genuinely untranslated. So program addresses from 0xC000 0000 - 0xFFFF FFFF emerge as identical physical addresses.

This means that “base” versions can generate most physical addresses (without the use of an MMU), except for a gap between 512Mbyte and 1Gbyte (0x2000 0000 through 0x3FFF FFFF). As noted above, many systems may ignore high-order address bits when performing address decoding, thus condensing all physical memory into the lowest 512MB addresses.

### Subsegments in the R3041 - memory width configuration

The R3041 CPU can be configured to access different regions of memory as either 32-, 16- or 8-bits wide. Where the program requests a 32-bit operation to a narrow memory (either with an uncached access, or a cache miss, or a store), the CPU may break a transaction into multiple data phases, to match the datum size to the memory port width.

The width configuration is applied independently to subsegments of the normal *kseg* regions, as follows:

- *kseg0* and *kseg1*: as usual, these are both mapped onto the low 512Mbytes. This common region is split into 8 subsegments (64Mbytes each), each of which can be programmed as 8-, 16- or 32-bits wide. The width assignment affects both *kseg0* and *kseg1* accesses (that is, one can view these as subsegments of the corresponding “physical” addresses).

- *kuseg*: is divided into four 512Mbyte subsegments, each independently programmable for width. Thus, *kuseg* can be broken into multiple portions, which may have varying widths. An example of this may be a 32-bit main memory with some 16-bit PCMCIA font cards and an 8-bit NVRAM.
- *kseg2*: is divided into two 512Mbyte subsegments, independently programmable for width. Again, this means that *kseg2* can support multiple memory subsystems, of varying port width.

Note that once the various memory port widths have been configured (typically at boot time), software does not have to be aware of the actual width of any memory system. It can choose to treat all memory as 32-bit wide, and the CPU will automatically adjust when an access is made to a narrower memory region. This simplifies software development, and also facilitates porting to various system implementations (which may or may not choose the same memory port widths).

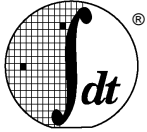

This chapter describes the software techniques used to recognize and decode exceptions, save state, dispatch exception service routines, and return from exception. Various code examples are provided.

## **EXCEPTIONS**

In the MIPS architecture interrupts, traps, system calls and everything else which disrupts the normal flow of execution are called “exceptions” and handled by a single mechanism. These kinds of events include:

- *External events*: interrupts, or a bus error on a read. Note that for the R30xx floating point exceptions are reported as interrupts, since when the R3000A was originally implemented the FPA was indeed external.

Interrupts are the only exception conditions which can be disabled under software control.

- *Program errors and unusual conditions*: non-existent instructions (including “co-processor” instructions executed with the appropriate *SR* disabled), integer overflow, address alignment errors, accesses outside *kuseg* in user mode.
- *Memory translation exceptions*: using an invalid translation, or a write to a write-protected page; and access to a page for which there is no translation in the TLB.
- *System calls and traps*: exceptions deliberately generated by software to access kernel facilities in a secure way (syscalls, conditional traps planted by careful code, and breakpoints).

Some things do not cause exceptions, although other CPU architectures may handle them that way. Software must use other mechanisms to detect:

- bus errors on write cycles (R30xx CPUs don’t detect these as exceptions at all; the use of a write buffer would make such an exception “imprecise”, in that the instruction which generated the store data is not guaranteed to be the one which recognizes the exception).
- parity errors detected in the cache (the PE bit in *SR* is set, but no exception is signalled).

## **Precise exceptions**

The MIPS architecture implements *precise exceptions*. This is quite a useful feature, as it provides:

- *Unambiguous proof of cause*: after an exception caused by any internal error, the EPC points to the instruction which caused the error (it might point to the preceding branch for an instruction which is in a branch delay slot, but will signal occurrence of this using the BD bit).
- *Exceptions are seen in instruction sequence*: exceptions can arise at several different stages of execution, creating a potential hazard. For example, if a load instruction suffers a TLB miss the exception won’t be signalled until the “MEM” pipestage; if the next instruction suffers an instruction TLB miss (at the “IF” pipestage) the logically second exception will be signalled first (since the IF occurs earlier in the pipe than MEM).



To avoid this problem, early-detected exceptions are not activated until it is known that all previous instructions will complete successfully; in this case, the instruction TLB miss is suppressed and the exception caused by the earlier instruction handled. The second exception will likely happen again upon return from handling the data fault.

- *Subsequent instructions nullified*: because of the pipelining, instructions lying in sequence after the EPC may well have been started. But the architecture guarantees that no effects produced by these instructions will be visible in the registers or CPU state; and no effect at all will occur which will prevent execution being restarted at the EPC.

Note that this isn't quite true of, for example, the result registers in the integer multiply unit (logically, the architecture considers these changed by the initiation of a multiply or divide). But provided that the instruction arrangement rules required by the assembler are followed, no problems will arise.

The implementation of precise exceptions requires a number of clever techniques. For example, the FPA cannot update the register file until it knows that the operation will not generate an exception. However, the R30xx family contains logic to allow multi-cycle FPA operations to occur concurrently with integer operations, yet maintain precise exceptions.

### When exceptions happen

Since exceptions are precise, the architecture determines that an exception seems to have happened just before the execution of the instruction which caused it. The first fetch from the exception routine will be made within 1 clock of the time when the faulting instruction would have finished; in practice it is often faster.

On an interrupt, the last instruction to be completed before interrupt processing starts will be the one which has just finished its MEM stage when the interrupt is detected. The *EPC* target will be the one which has just finished its ALU stage.

However, take care; some of the interrupt inputs to R30xx family CPUs are resynchronised internally (to support interrupt signalling from asynchronous sources) and the interrupt will be detected only on the rising edge of the second clock after the interrupt becomes active.

### Exception vectors

Unlike most CISC processors, the MIPS CPU does no part of the job of dispatching exceptions to specialist routines to deal with individual conditions. The rationale for this is twofold:

- on CISC CPUs this feature is not so useful in practice as one might hope. For example, most interrupts are likely to share code for saving registers and it is common for CISC microcode to spend time dispatching to different interrupt entry points, where system software loads a code number and jumps back to a common handler.
- on a RISC CPU ordinary code is fast enough to be used in preference to microcode.

Only one exception is handled differently; a TLB miss on an address in *kuseg*. Although the architecture uses software to handle this condition (which occurs very frequently in a heavily-used multi-tasking, virtual memory OS), there is significant architectural support for a "preferred" scheme for TLB refill. The preferred refill scheme can be completed in about 13 clocks.

It is also useful to have two alternate pairs of entry points. It is essential for high performance to locate the vectors in cached memory for OS use, but this is highly undesirable at start-up; the need for a robust and self-diagnosing start-up sequence mandates the use of uncached read-only memory for vectors.

So the exception system adds four more “magic” addresses to the one used for system start-up. The reset mechanism on the MIPS CPU is remarkably like the exception mechanism, and is sometimes referred to as the *reset exception*. The complete list of exception vector addresses is shown in Table 4.1, “Reset and exception entry points (vectors) for R30xx family”:

Program address	“segment”	Physical Address	Description
0x8000 0000	kseg0	0x0000 0000	TLB miss on <i>kuseg</i> reference only.
0x8000 0080	kseg0	0x0000 0080	All other exceptions.
0xbf0c0 0100	kseg1	0x1fc0 0100	Uncached alternative <i>kuseg</i> TLB miss entry point (used if <i>SR</i> bit BEV set).
0xbf0c0 0180	kseg1	0x1fc0 0180	Uncached alternative for all other exceptions, used if <i>SR</i> bit BEV set).
0xbf0c0 0000	kseg1	0x1fc0 0000	The “reset exception”.

**Table 4.1. Reset and exception entry points (vectors) for R30xx family**

The 128 byte (0x80) gap between the two exception vectors is because the MIPS architects felt that 32 instructions would be enough to code the user-space TLB miss routine, saving a branch instruction without wasting too much memory.

So on an exception, the CPU:

- 1) sets up *EPC* to point to the restart location.
- 2) the pre-existing user-mode and interrupt-enable flags in *SR* are saved by pushing the 3-entry stack inside *SR*, and changing to kernel mode with interrupts disabled.
- 3) *Cause* is setup so that software can see the reason for the exception. On address exceptions *BadVaddr* is also set. Memory management system exceptions set up some of the MMU registers too; see the chapter on memory management for more detail.
- 4) transfers control to the exception entry point.

### Exception handling – basics

Any MIPS exception handler has to go through the same stages:

- *Bootstrapping*: on entry to the exception handler very little of the state of the interrupted program has been saved, so the first job is to provide room to preserve relevant state information.

Almost inevitably, this is done by using the *k0* and *k1* registers (which are reserved for “kernel mode” use, and therefore should contain no application program state), to reference a piece of memory which can be used for other register saves.

- *Dispatching different exceptions*: consult the *Cause* register. The initial decision is likely to be made on the “ExcCode” field, which is thoughtfully aligned so that its code value (between 0 and 31) can be used to index an array of words without a shift. The code will be something like this:

```

mfc0    t1, C0_CAUSE
and     t2, t1, 0x3f
lw      t2, tablebase(t2)
jr      t2

```

- *Constructing the exception processing environment*: complex exception handling routines may be written in a high level language; in addition, software may wish to be able to use standard library routines. To do this, software will have to switch to a suitable stack, and save the values of all registers which “called subroutines” may use.
- *Processing the exception*: this is system and cause dependent.
- *Returning from an exception*: The return address is contained in the *EPC* register on exception entry; the value must be placed into a general purpose register for return from exception (note that the *EPC* value may have been placed on the stack at exception entry). Returning control is now done with a *jr* instruction, and the change of state back from kernel to the previous mode is done by an *rfe* instruction after the *jr*, in the delay slot.

## Nesting exceptions

In many cases the system may wish to permit (or will not be able to avoid) further exceptions occurring within the exception processing routine – *nested* exceptions.

If improperly handled, this could cause chaos; vital state for the interrupted program is held in *EPC* and *SR*, and another exception would overwrite them. To permit nested exceptions, these values must be saved elsewhere. Moreover, once exceptions are re-enabled, software can no longer rely on the values of *k0* and *k1*, since a subsequent (nested) exception may alter their values.

The normal approach to this is to define an *exception frame*; a memory-resident data structure with fields to store incoming register values, so that they can be retrieved on return. Exception frames are usually arranged logically as a stack.

Stack resources are consumed by each exception, so arbitrarily nested exceptions cannot be tolerated. Most systems sort exceptions into a priority order, and arrange that while an exception is being processed only higher-priority exceptions are permitted. Such systems need have only as many exception frames as there are priority levels.

Software can inhibit certain exceptions, as follows:

- *Interrupts*: can be individually masked by software to conform to system priority rules;
- *Privilege Violations*: can't happen in kernel mode; virtually all exception service routines will execute in kernel mode;
- *Addressing errors and TLB misses*: software must be written to ensure that these never happen when processing higher priority exceptions.

Typical system priorities are (lowest first): non-exception code, TLB miss on *kuseg* address, TLB miss on *kseg2* address, interrupt (lowest)... interrupt (highest), illegal instructions and traps, bus errors.

## An exception routine

The following is an exception routine from IDT/sim.

It receives exceptions, saves all state, and calls the appropriate service routine. It also shows the code used to install the exception handler in memory.

```

/*
**      exception.s - contains functions for setting up and
**                  handling exceptions
**
**      Copyright 1989 Integrated Device Technology, Inc.
**      All Rights Reserved
**
*/

```

```

#include "iregdef.h"
#include "idtcpu.h"
#include "idtmon.h"
#include "setjmp.h"
#include "excepthdr.h"

/*
**  move_exc_code() - moves the exception code to the utlb and
gen
**                      exception vectors
**
*/
FRAME(move_exc_code,sp,0,ra)
    .set    noreorder
    la     t1,exc_utlb_code
    la     t2,exc_norm_code
    li     t3,UT_VEC
    li     t4,E_VEC
    li     t5,VEC_CODE_LENGTH
1:
    lw     t6,0(t1)
    lw     t7,0(t2)
    sw     t6,0(t3)
    sw     t7,0(t4)
    addiu  t1,4
    addiu  t3,4
    addiu  t4,4
    subu   t5,4
    bne    t5,zero,1b
    addiu  t2,4
    move   t5,ra          # assumes clear_cache doesnt use t5
    li    a0,UT_VEC
    jal   clear_cache
    li    a1,VEC_CODE_LENGTH
    nop
    li    a0,E_VEC
    jal   clear_cache
    li    a1,VEC_CODE_LENGTH
    move  ra,t5          # restore ra
    j     ra
    nop
    .set  reorder
ENDFRAME(move_exc_code)
/*
** enable_int(mask) - enables interrupts - mask is positoned so it
only
**                      needs to be or'ed into the status reg. This
**                      also does some other things !!!! caution
should
**                      be used if invoking this while in the middle
**                      of a debugging session where the client may
have
**                      nested interrupts.
**
*/
FRAME(enable_int,sp,0,ra)
    .set    noreorder
    la     t0,client_regs
    lw     t1,R_SR*4(t0)
    nop
    or     t1,0x4
    or     t1,a0
    sw     t1,R_SR*4(t0)
    mfc0  t0,C0_SR
    or     a0,1
    or     t0,a0
    mtc0  t0,C0_SR
    j     ra

```

```

        nop
        .set  reorder
ENDFRAME(enable_int)
/*
**  disable_int(mask) - disable the interrupt - mask is the
compliment
**                      of the bits to be cleared - i.e. to clear
ext int
**                      5 the mask would be - 0xffff7fff
*/
FRAME(disable_int,sp,0,ra)
        .set  noreorder
        la    t0,client_regs
        lw    t1,R_SR*4(t0)
        nop
        and   t1,a0
        sw    t1,R_SR*4(t0)
        mfc0  t0,C0_SR
        nop
        and   t0,a0
        mtc0  t0,C0_SR
        j     ra
        nop
        .set  reorder
ENDFRAME(disable_int)

/*
** the following sections of code are copied to the vector area
** at location 0x80000000 (utlbmiss) and location 0x80000080
** (general exception).
**
**
*/

        .set  noreorder
        .set  noat          # must be set so la does not use at

FRAME(exc_norm_code,sp,0,ra)
        la    k0,except_regs
        sw    AT,R_AT*4(k0)
        sw    gp,R_GP*4(k0)
        sw    v0,R_V0*4(k0)
        li    v0,NORM_EXCEPT
        la    AT,exception
        j     AT
        nop
        ENDFRAME(exc_norm_code)
FRAME(exc_utlb_code,sp,0,ra)
        la    k0,except_regs
        sw    AT,R_AT*4(k0)
        sw    gp,R_GP*4(k0)
        sw    v0,R_V0*4(k0)
        li    v0,UTLB_EXCEPT
        la    AT,exception
        j     AT
        nop

        .set  reorder

/*
** common exception handling code
** Save various registers so we can print informative messages
** for faults (whether in monitor or client mode)
** Reg.(k0) points to the exception register save area.
** If we are in client mode then some of these values will
** have to be copied to the client register save area.
**
*/
        .set  noreorder

```

```

exception:
    sw    v0,R_EXCTYPE*4(k0) # save exception type (gen or
utlb)
    sw    v1,R_V1*4(k0)
    mfc0  v0,C0_EPC
    mfc0  v1,C0_SR
    sw    v0,R_EPC*4(k0)# save the pc at the time of the
exception
    sw    v1,R_SR*4(k0)
    .set  noat
    la    AT,client_regs# get address of client reg save area
    mfc0  v0,C0_BADVADDR
    mfc0  v1,C0_CAUSE
    sw    v0,R_BADVADDR*4(k0)
    sw    v0,R_BADVADDR*4(AT)
    sw    v1,R_CAUSE*4(k0)
    sw    v1,R_CAUSE*4(AT)
    sw    sp,R_SP*4(k0)
    sw    sp,R_SP*4(AT)
    lw    v0,user_int_fast#see if a client wants a shot at it
    sw    a0,R_A0*4(k0)
    sw    a0,R_A0*4(AT)
    sw    ra,R_RA*4(k0)
    sw    ra,R_RA*4(AT)
    lw    sp,fault_stack # use "fault" stack
    beq   v0,zero,lf      # skip the following if no client
    nop
    move  a0,AT
    jal   v0
    nop
    la    k0,except_regs
    la    AT,client_regs
    beq   v0,zero,lf      # returns false if user did not
handle
    nop
    la    v1,except_regs
    lw    ra,R_RA*4(v1)
    lw    AT,R_AT*4(v1)
    lw    gp,R_GP*4(v1)
    lw    v0,R_V0*4(v1)
    lw    sp,R_SP*4(v1)
    lw    a0,R_A0*4(v1)
    lw    k0,R_EPC*4(v1)
    lw    v1,R_V1*4(v1)
    j     k0
    rfe

/*
** Save registers if in client mode
** then change mode to prom mode currently k0 is pointing
** exception reg. save area - v0, v1, AT, gp, sp regs were saved
** epc, sr, badvaddr and cause were also saved.
*/
1:
    lw    v0,R_MODE*4(AT)# get the current op. mode
    lw    v1,R_EXCTYPE*4(k0)
    sw    v0,R_MODE*4(k0)# save the current prom mode
    sw    v1,R_EXCTYPE*4(AT)
    li    v1,MODE_MONITOR# see if it
    beq   v0,v1,nosave # was in prom mode
    nop
    li    v0,MODE_MONITOR
    sw    v0,R_MODE*4(AT)# now in prom mode
    lw    v0,R_GP*4(k0)
    lw    v1,R_EPC*4(k0)
    sw    v0,R_GP*4(AT)
    sw    v1,R_EPC*4(AT)
    lw    v0,R_SR*4(k0)
    lw    v1,R_AT*4(k0)

```

```

sw    v0,R_SR*4(AT)
sw    v1,R_AT*4(AT)
lw    v0,R_V0*4(k0)
lw    v1,R_V1*4(k0)
sw    v0,R_V0*4(AT)
sw    v1,R_V1*4(AT)
sw    a1,R_A1*4(AT)
sw    a2,R_A2*4(AT)
sw    a3,R_A3*4(AT)
sw    t0,R_T0*4(AT)
sw    t1,R_T1*4(AT)
sw    t2,R_T2*4(AT)
sw    t3,R_T3*4(AT)
sw    t4,R_T4*4(AT)
sw    t5,R_T5*4(AT)
sw    t6,R_T6*4(AT)
sw    t7,R_T7*4(AT)
sw    s0,R_S0*4(AT)
sw    s1,R_S1*4(AT)
sw    s2,R_S2*4(AT)
sw    s3,R_S3*4(AT)
sw    s4,R_S4*4(AT)
sw    s5,R_S5*4(AT)
sw    s6,R_S6*4(AT)
sw    s7,R_S7*4(AT)
sw    t8,R_T8*4(AT)
li    v0,0xbababadd#This reg (k0) is invalid
sw    t9,R_T9*4(AT)
sw    v0,R_K0*4(AT) # should be obvious
sw    k1,R_K1*4(AT)
sw    fp,R_FP*4(AT)
lw    v0,status_base
move  v1,AT
and   v0,SR_CU1
beq   v0,zero,1f          # only save fpu regs if
present
move  AT,v1
lw    v1,R_SR*4(AT)
and   v0,v1
mtc0  v0,C0_SR
nop
cfc1  v0,$30
cfc1  v1,$31
sw    v0,R_FEIR*4(AT)
sw    v1,R_FCSR*4(AT)
swc1  fp0,R_F0*4(AT)
swc1  fp1,R_F1*4(AT)
swc1  fp2,R_F2*4(AT)
swc1  fp3,R_F3*4(AT)
swc1  fp4,R_F4*4(AT)
swc1  fp5,R_F5*4(AT)
swc1  fp6,R_F6*4(AT)
swc1  fp7,R_F7*4(AT)
swc1  fp8,R_F8*4(AT)
swc1  fp9,R_F9*4(AT)
swc1  fp10,R_F10*4(AT)
swc1  fp11,R_F11*4(AT)
swc1  fp12,R_F12*4(AT)
swc1  fp13,R_F13*4(AT)
swc1  fp14,R_F14*4(AT)
swc1  fp15,R_F15*4(AT)
swc1  fp16,R_F16*4(AT)
swc1  fp17,R_F17*4(AT)
swc1  fp18,R_F18*4(AT)
swc1  fp19,R_F19*4(AT)
swc1  fp20,R_F20*4(AT)
swc1  fp21,R_F21*4(AT)
swc1  fp22,R_F22*4(AT)

```

```

        swc1    fp23,R_F23*4(AT)
        swc1    fp24,R_F24*4(AT)
        swc1    fp25,R_F25*4(AT)
        swc1    fp26,R_F26*4(AT)
        swc1    fp27,R_F27*4(AT)
        swc1    fp28,R_F28*4(AT)
        swc1    fp29,R_F29*4(AT)
        swc1    fp30,R_F30*4(AT)
        swc1    fp31,R_F31*4(AT)
1:
        mflo    v0
        mfhi    v1
        sw      v0,R_MDLO*4(AT)
        sw      v1,R_MDHI*4(AT)
        mfc0    v0,C0_INX
        mfc0    v1,C0_RAND
        sw      v0,R_INX*4(AT)
        sw      v1,R_RAND*4(AT)
        mfc0    v0,C0_TLBLO
        mfc0    v1,C0_TLBHI
        sw      v0,R_TLBLO*4(AT)
        mfc0    v0,C0_CTXT
        sw      v1,R_TLBHI*4(AT)
        sw      v0,R_CTXT*4(AT)
        .set    at
nosave:
        .set    reorder
        j       exception_handler

        ENDFRAME(exc_utlb_code)
/*
** resume -- resume execution of client code
*/
FRAME(resume,sp,0,ra)
        jal    install_sticky
        jal    clr_extern_brk
        jal    clear_remote_int
        .set   noat
        .set   noreorder
        la     AT,client_regs
        lw     v0,status_base
        move   v1,AT
        and    v0,SR_CU1
        beq    v0,zero,1f    # only save fpu regs if present
        move   AT,v1
        lw     v1,R_SR*4(AT)
        nop
        or     v0,v1
        mtc0   v0,C0_SR
        lw     v1,R_FCSR*4(AT)
        lwc1   fp0,R_F0*4(AT)
        ctcl   v1,$31
        lwc1   fp1,R_F1*4(AT)
        lwc1   fp2,R_F2*4(AT)
        lwc1   fp3,R_F3*4(AT)
        lwc1   fp4,R_F4*4(AT)
        lwc1   fp5,R_F5*4(AT)
        lwc1   fp6,R_F6*4(AT)
        lwc1   fp7,R_F7*4(AT)
        lwc1   fp8,R_F8*4(AT)
        lwc1   fp9,R_F9*4(AT)
        lwc1   fp10,R_F10*4(AT)
        lwc1   fp11,R_F11*4(AT)
        lwc1   fp12,R_F12*4(AT)
        lwc1   fp13,R_F13*4(AT)
        lwc1   fp14,R_F14*4(AT)
        lwc1   fp15,R_F15*4(AT)
        lwc1   fp16,R_F16*4(AT)

```



```

lwc1    fp17,R_F17*4(AT)
lwc1    fp18,R_F18*4(AT)
lwc1    fp19,R_F19*4(AT)
lwc1    fp20,R_F20*4(AT)
lwc1    fp21,R_F21*4(AT)
lwc1    fp22,R_F22*4(AT)
lwc1    fp23,R_F23*4(AT)
lwc1    fp24,R_F24*4(AT)
lwc1    fp25,R_F25*4(AT)
lwc1    fp26,R_F26*4(AT)
lwc1    fp27,R_F27*4(AT)
lwc1    fp28,R_F28*4(AT)
lwc1    fp29,R_F29*4(AT)
lwc1    fp30,R_F30*4(AT)
lwc1    fp31,R_F31*4(AT)

1:
lw      a0,R_A0*4(AT)
lw      a1,R_A1*4(AT)
lw      a2,R_A2*4(AT)
lw      a3,R_A3*4(AT)
lw      t0,R_T0*4(AT)
lw      t1,R_T1*4(AT)
lw      t2,R_T2*4(AT)
lw      t3,R_T3*4(AT)
lw      t4,R_T4*4(AT)
lw      t5,R_T5*4(AT)
lw      t6,R_T6*4(AT)
lw      t7,R_T7*4(AT)
lw      s0,R_S0*4(AT)
lw      s1,R_S1*4(AT)
lw      s2,R_S2*4(AT)
lw      s3,R_S3*4(AT)
lw      s4,R_S4*4(AT)
lw      s5,R_S5*4(AT)
lw      s6,R_S6*4(AT)
lw      s7,R_S7*4(AT)
lw      t8,R_T8*4(AT)
lw      t9,R_T9*4(AT)
lw      k1,R_K1*4(AT)
lw      gp,R_GP*4(AT)
lw      fp,R_FP*4(AT)
lw      ra,R_RA*4(AT)
lw      v0,R_MDLO*4(AT)
lw      v1,R_MDHI*4(AT)
mtlo    v0
mthi    v1
lw      v0,R_INX*4(AT)
lw      v1,R_TLBLO*4(AT)
mtc0    v0,C0_INX
mtc0    v1,C0_TLBLO
lw      v0,R_TLBHI*4(AT)
lw      v1,R_CTXT*4(AT)
mtc0    v0,C0_TLBHI
mtc0    v1,C0_CTXT
lw      v0,R_CAUSE*4(AT)
lw      v1,R_SR*4(AT)
mtc0    v0,C0_CAUSE      /* only sw0 and 1 writable */
move    v0,AT
and     v1,~(SR_KUC|SR_IEC|SR_PE)/* make sure we aren't
intr */
mtc0    v1,C0_SR
li      k0,MODE_USER
move    AT,v0
sw      k0,R_MODE*4(AT)  /* reset mode */
lw      v1,R_V1*4(AT)
lw      sp,R_SP*4(AT)
lw      k0,R_EPC*4(AT)
lw      v0,R_V0*4(AT)

```

```

        lw    AT,R_AT*4(AT)
        j     k0
        rfe
        .set  reorder
        .set  at
        ENDFRAME(resume)

/*
** do_call(procedure, arg1, arg2, arg3, arg4, arg5, arg6, arg7,
arg8)
** interface for call command to client code
** copies arguments to new frame and sets up gp for client
*/
#define CALLFRM ((8*4)+4+4)
FRAME(do_call, sp, CALLFRM, ra)
    subu    sp, CALLFRM
    sw      ra, CALLFRM-4(sp)
    sw      gp, CALLFRM-8(sp)
    move    v0, a0
    move    a0, a1
    move    a1, a2
    move    a2, a3
    lw      a3, CALLFRM+(4*4)(sp)
    lw      v1, CALLFRM+(5*4)(sp)
    sw      v1, 4*4(sp)
    lw      v1, CALLFRM+(6*4)(sp)
    sw      v1, 5*4(sp)
    lw      v1, CALLFRM+(7*4)(sp)
    sw      v1, 6*4(sp)
    lw      v1, CALLFRM+(8*4)(sp)
    sw      v1, 7*4(sp)
    la      t1, client_regs
    lw      gp, R_GP*4(t1)
    jal     v0
    lw      gp, CALLFRM-8(sp)
    lw      ra, CALLFRM-4(sp)
    addu    sp, CALLFRM
    j       ra
    ENDFRAME(do_call)

/*
** clear_stat() -- clear status register
** returns current sr
*/
FRAME(clear_stat, sp, 0, ra)
    .set    noreorder
    lw      v1, status_base
    mfc0    v0, C0_SR
    mtc0    v1, C0_SR
    j       ra
    nop
    ENDFRAME(clear_stat)

    .set    reorder

/*
** setjmp(jmp_buf) -- save current context for non-local goto's
** return 0
*/
FRAME(setjmp, sp, 0, ra)
    sw      ra, JB_PC*4(a0)
    sw      sp, JB_SP*4(a0)
    sw      fp, JB_FP*4(a0)
    sw      s0, JB_S0*4(a0)
    sw      s1, JB_S1*4(a0)
    sw      s2, JB_S2*4(a0)
    sw      s3, JB_S3*4(a0)
    sw      s4, JB_S4*4(a0)

```

```

sw    s5,JB_S5*4(a0)
sw    s6,JB_S6*4(a0)
sw    s7,JB_S7*4(a0)
move  v0,zero
j     ra
ENDFRAME(set jmp)

/*
** longjmp(jmp_buf, rval)
*/
FRAME(longjmp,sp,0,ra)
lw    ra,JB_PC*4(a0)
lw    sp,JB_SP*4(a0)
lw    fp,JB_FP*4(a0)
lw    s0,JB_S0*4(a0)
lw    s1,JB_S1*4(a0)
lw    s2,JB_S2*4(a0)
lw    s3,JB_S3*4(a0)
lw    s4,JB_S4*4(a0)
lw    s5,JB_S5*4(a0)
lw    s6,JB_S6*4(a0)
lw    s7,JB_S7*4(a0)
move  v0,a1
j     ra
ENDFRAME(longjmp)

/*
** wbflush() flush the write buffer - this is specific for each
hardware
**                configuration.
*/
FRAME(wbflush,sp,0,ra)
.set noreorder

lw    t0,wbflush#read an uncached memory location
j     ra
nop
.set reorder
ENDFRAME(wbflush)

```

## INTERRUPTS

The MIPS CPUs are provided with 6 individual hardware interrupt bits, activated by CPU input pins (in the case of the R3081, one pin is used internally by the FPA), and 2 additional software-settable interrupt bits. An active level on any pin is sensed in each cycle, and will cause an exception if enabled.

The interrupt enable comes in two parts:

- The global interrupt enable bit (IEc) in the status register – when zero no interrupt exception will occur. Simple, fast and comprehensive, this is what prevents interrupts occurring during the early and vulnerable stages of processing exceptions. Also, the global interrupt enable is usually switched back on by an *rfe* instruction at the end of an exception routine; this means that the interrupt cannot take effect until the CPU has returned from the exception and finished with the *EPC* register, avoiding undesirable recursion in the interrupt routine.
- The individual interrupt mask bits IM in the status register, one for each interrupt. Set the bit 1 to enable the corresponding interrupt. These are manipulated by software to allow whichever interrupts are appropriate to the system.

Changes to the individual bits are usually made “under cover”, with the global interrupt enable off.

#### What are the software interrupt bits for?

One commonly asked question is: “Why does the CPU provide two bits in the *Cause* register which, when set, immediately cause an interrupt unless masked?”

The clue is in “unless masked”. Typically this is used as a mechanism for high-priority interrupt routines to flag actions which will be performed by lower-priority interrupt routines, once the system has dealt with all high priority business. As the high-priority processing completes, the software will open up the interrupt mask, and the pending software interrupt will occur.

There is no definitive reason why the same effect should not be simulated by system software (using flags in memory, for example) but the soft interrupt bits are convenient because they fit in with the already provided interrupt handling mechanism.

Pin	SR/Cause bit no	Notes
	8	software interrupt
	9	software interrupt
Int0*	10	Cause bit reads 1 when pin low (active)
Int1*	11	
Int2*	12	
Int3*	13	Usual choice for FPA. The pin corresponding to the interrupt selected for FPA interrupts on an R3081 is effectively a no-connect.
Int4*	14	
Int5*	15	

**Table 4.2. Interrupt bitfields and interrupt pins**

Interrupt processing proper begins after an exception is received and the Type field in *Cause* signals that it was caused by an interrupt. Table 4.2, “Interrupt bitfields and interrupt pins” describes the relationship between *Cause* bits and input pins.

Once the interrupt exception is “recognized” by the CPU, the stages are:

- Consult the *Cause* register IP field, logically-“and” it with the current interrupt masks in the *SR* IM field to obtain a bit-map of active, enabled interrupt requests. There may be more than one, and any of them would have caused the interrupt.
- Select one active, enabled interrupt for attention. The selection can be done simply by using fixed priorities; however, software is free to implement whatever priority mechanism is appropriate for the system.
- Software needs to save the old interrupt mask bits of the *SR* register, but it is quite likely that the whole *SR* register was saved in the main exception routine.
- Change IM in *SR* to ensure that the current interrupt and all interrupts of equal or lesser priority are inhibited.
- If not already performed by the main exception routine, save the state required for nested exception processing.
- Set the global interrupt enable bit IEC in *SR* to allow higher-priority interrupts to be processed.

- Call the particular interrupt service routine for the selected, current interrupt.
- On return, disable interrupts again by clearing IEC in SR, before returning to the normal exception stream.

### Conventions and Examples

The following is as simple as an exception routine can be. It does nothing except increment a counter on each exception:

```
.set noreorder
.set noat
xcptgen:
    la    k0,xcptcount# get address of counter
    lw    k1,0(k0)# load counter
    nop                    # (load delay)
    addu  k1,1            # increment counter
    sw    k1,0(k0)# store counter
    mfc0  k0,C0_EPC# get EPC
    nop                    # (load delay, mfc0 slow)
    j     k0              # return to program
    rfe                    # branch delay slot
.set at
.set reorder
```

Note that this routine cannot survive a nested exception (the original return address in *EPC* would be lost, for example). It doesn't re-enable interrupts; but note that the counter *xcptcount* should be at an address which can't possibly suffer a TLB miss.

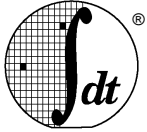

**CACHES AND CACHE MANAGEMENT**

R30xx family CPUs implement separate on-chip caches for instructions (I-cache) and data (D-cache). Following RISC principles, hardware functions are provided only for normal operation of the caches; software routines must be provided to initialize the cache following system start-up, and to invalidate cache data when required†.

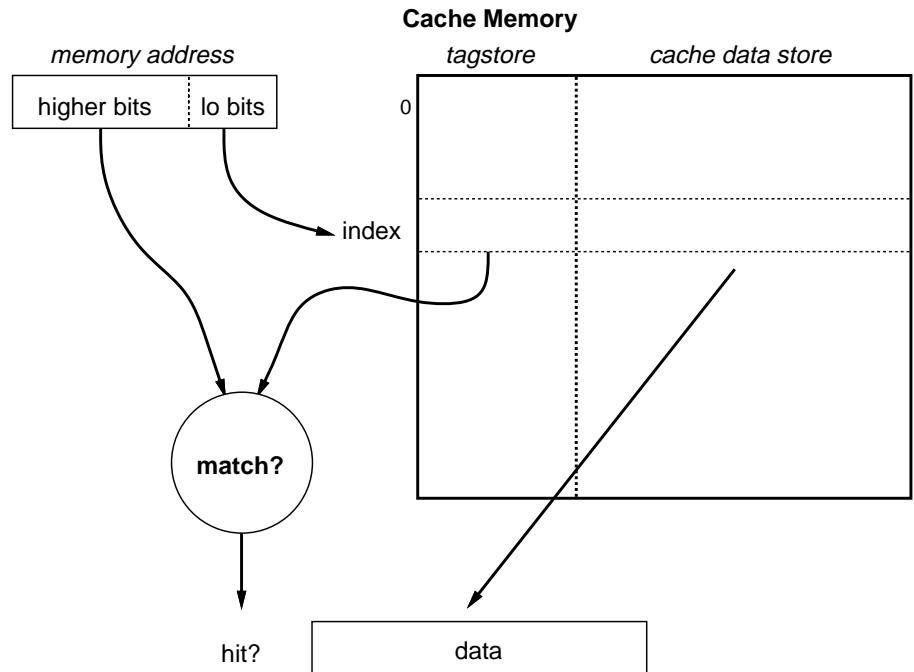

**Figure 5.1. Direct mapped cache**

The cache's job is to hold a copy of memory data which has been recently read or written, so it can be returned quickly to the CPU; in the R30xx architecture data accesses in the cache take just one clock, and an I-cache and a D-cache operation can occur together.

When a cacheable location is read (a data load):

- It will be returned from the D-cache if the cache contains the corresponding physical address and the cache line is valid there (called a cache "hit"). In this case nothing happens at the CPU's memory interface, so the read is invisible to the outside world.
- If the data is not found in the D-cache (called a cache "miss"), the data will be read from external memory. According to the CPU type and how it is set up, it may read one or more words from memory. The data is loaded into the cache, and normal operation then resumes.

In normal operation, cache miss processing will cause the targeted cache line to "invalidate" the valid data already present in the cache. In the R30xx caches, cache data is never more up-to-date than memory (because the cache is *write-through*, described below), so the previously cached data can be discarded without any trouble.

† Note that the R3071 and R3081 do implement a DMA protocol that allows automatic, hardware-based data cache invalidation.

When data is loaded from an uncacheable location, it is always obtained from external memory (or a memory-mapped IO location). Most systems never access the same data locations as cached and uncached; however, the results of such a system would be predictable. On an uncacheable load cache data is neither used nor updated.

When software writes a cached location:

- If the CPU is doing a 32-bit store, the cache is always updated (possibly discarding data from a previously cached location).
- For byte or half-word stores, the cache will only be updated if the reference hits in the cache; then data will be extracted from the cache, merged with the store data, and written back<sup>†</sup>.
- If the partial-word store misses in the cache, then the cache is left alone.
- In all cases, the write is also made to main memory.

When the store target is an uncached location the cache is not consulted or modified.

Figure 5.1, “Direct mapped cache” is a diagrammatic representation of the way the MIPS cache works. Both caches are:

- *Physically indexed, physically tagged*: the CPU's program address (virtual address) is translated to a physical address, just as is used to address real memory, before being used for the cache lookup. The TAG comparison (checking for a hit) is also based on physical addresses.

On certain other CPU families the cache index is based on program addresses (which are available a bit earlier); some CPUs even use virtual TAGs, which then require that the cache be flushed at context switch. But physical caches are easier to manage.

- *Direct mapped*: Each physical address has only one location in each cache where it may reside. At each cache index there is only one data item stored – this will be just one word in the D-cache but is usually a 4-word *line* for the I-cache (see Figure 5.1, “Direct mapped cache”). Next to the data is kept the *tag*, which stores the memory address for which this data is a copy.

If the tag matches the high-order (higher number) address bits then the cache line contains the data the CPU is looking for; the data is returned and execution continues.

For an I-cache access, the CPU must select one of the four words based on the lowest address bits.

This is a *direct mapped* cache because there is only one tag/data pair at each cache index. More complex caches may have more than one tag field, and compare them simultaneously with the physical address.

A direct-mapped cache is very simple, but can suffer from cache thrashing; so the CPU can run slowly if a program loop is regularly accessing a pair of locations whose low-order addresses happen to be equal. To avoid this situation, the R30xx family implements relatively large caches, which minimize the probability of reasonable program loops causing CPU thrashing.

- *Cache lines*: the line size is the number of data elements stored with each tag. For R30xx family CPUs the I-cache implements a 4-word line size; the D-cache always has 1-word lines.

---

<sup>†</sup> In the R30xx family, the data will be merged in the D-Cache. However, the CPU bus will perform the store only to the bytes which were actually changed (i.e. the store datum size), facilitating debugging.

When a cache miss occurs the whole line must be filled from memory. But it is quite possible to fetch more than a line's worth of data; and R30xx family CPUs can be configured to fetch 4 words of data on a D-cache miss, refilling 4 1-word "lines".

- *Write through*: the D-cache is write-through, meaning that all store operations result in a store to main memory. This means that all data in the cache is duplicated in main memory, and can therefore be discarded at any time. In particular, when data is being read following a cache miss it can always be stored in the cache without regard for the data which was previously stored at the same index.
- *Partial word write implementations*: when the CPU writes only part of a word, it is essential that any valid cache data should still end up as a duplicate of main memory. One simple approach is to invalidate the cache line and to write only to main memory (the main memory must be byte-addressable). But the R30xx family uses a more efficient strategy:
  - a) if the location being written is present in the cache (cache hit) the cache data is read into the CPU, the partial-word data merged with it, the whole word written back to the cache, and the partial-word written to memory.
  - b) where the write misses in the cache the partial-word write is performed to memory only, and the cache left alone.

Note that this takes an extra clock, so a partial-word write which hits in the cache is slower than a whole-word write.

### Cache isolation and swapping

No special instructions are provided to explicitly access the caches; everything has to be done with load and store instructions.

To distinguish operations for cache management from regular memory references, without having to dedicate a special address region for this purpose, the R30xx architecture provides bits in the *SR* to support cache management:

- The *SR* mode bit "IsC" will *isolate* the D-cache; in this mode loads and stores affect only the cache, and loads also "hit" regardless of whether the tag matches. As a special mechanism, with the D-cache isolated a partial-word write will invalidate the appropriate cache line.

Caution: when the D-cache is isolated, not even loads/stores marked by their address or TLB entry as "uncached" will operate normally. One consequence of this is that the cache management routines must not make any data accesses; they are typically written in assembler, using only register variables.

- The CPU provides a mode where the caches are *swapped* (*SR SwC* bit), to allow the I-Cache to be targeted by store instructions; then the D-cache acts as an I-cache, and the I-cache acts as the D-cache. Once the caches are swapped and isolated I-cache entries may be read, written and invalidated (invalidation uses the same partial word write mechanism described above).

Note that cache isolation does not stop instruction fetches from referencing main memory.

The D-cache behaves "perfectly" as an I-cache (provided it was sufficiently initialized to work as a D-cache) but the I-cache does not behave properly as a D-cache. It is unlikely that it will ever be useful to have the caches swapped but not isolated.

If software does use a swapped I-cache for word stores (a partial-word store invalidates the line, as before) it must make sure those locations are invalidated before returning to normal operation.



## Initializing and sizing the caches

At machine start-up the caches are in a random state, so the result of a cached read is unpredictable. In addition, following a reset the status register SwC and IsC bits are also in a random state, so start-up software had better set them to a known state before attempting any load or store (even uncached).

Different members of the R3051 family have different cache sizes. Software will be more portable if it dynamically determines the size of the I-cache and D-cache at initialization time, rather than hard-wiring a particular value.

A number of algorithms are possible. Shown below is the code contained in IDT/sim for cache sizing. The basic algorithm works as follows: isolate the D-cache;

- swap the caches when sizing the I-cache;
- Write a marker into the initial cache entry.
- Start with the smallest permissible cache size.
- Read memory at the location for the current cache size. If it contains the marker, that is the correct size. Otherwise, double the size to try and repeat this step until the marker is found.

```

/*
** Config_cache() -- determine sizes of i and d caches
** Sizes stored in globals dcache_size and icache_size
*/
#define CONFIGFRM ((4*4)+4+4)
FRAME(config_cache,sp, CONFIGFRM, ra)
    .set    noreorder
    subu   sp,CONFIGFRM
    sw     ra,CONFIGFRM-4(sp)# save return address
    sw     s0,4*4(sp)    # save s0 in first regsave slot
    mfc0   s0,C0_SR      # save SR
    mtc0   zero,C0_SR    # disable interrupts
    .set    reorder
    jal    _size_cache
    sw     v0,dcache_size
    li     v0,SR_SWC     # swap caches
    .set    noreorder
    mtc0   v0,C0_SR
    jal    _size_cache
    nop
    sw     v0,icache_size
    mtc0   zero,C0_SR    # swap back caches
    and    s0,~SR_PE     # do not inadvertently clear PE
    mtc0   s0,C0_SR      # restore SR
    .set    reorder
    lw     s0,4*4(sp)    # restore s0
    lw     ra,CONFIGFRM-4(sp)# restore ra
    addu   sp,CONFIGFRM # pop stack
    j      ra
ENDFRAME(config_cache)

/*
** _size_cache()
** return size of current data cache
*/
FRAME(_size_cache,sp,0,ra)
    .set    noreorder
    mfc0   t0,C0_SR      # save current sr
    and    t0,~SR_PE     # do not inadvertently clear PE
    or     v0,t0,SR_ISC  # isolate cache
    mtc0   v0,C0_SR
    /*
    * First check if there is a cache there at all
    */
    move   v0,zero
    li     v1,0xa5a5a5a5 # distinctive pattern

```

```

        sw    v1,KOBASE    # try to write into cache
        lw    t1,KOBASE    # try to read from cache
        nop
        mfc0  t2,C0_SR
        nop
        .set  reorder
        and   t2,SR_CM
        bne   t2,zero,3f    # cache miss, must be no cache
        bne   v1,t1,3f     # data not equal -> no cache
        /*
        * Clear cache size boundries to known state.
        */
1:      li    v0,MINCACHE

        sw    zero,KOBASE(v0)
        sll   v0,1
        ble   v0,MAXCACHE,1b

        li    v0,-1
        sw    v0,KOBASE(zero)# store marker in cache
        li    v0,MINCACHE  # MIN cache size

2:      lw    v1,KOBASE(v0) # Look for marker
        bne   v1,zero,3f    # found marker
        sll   v0,1          # cache size * 2
        ble   v0,MAXCACHE,2b# keep looking
        move  v0,zero       # must be no cache
        .set  noreorder

3:      mtc0  t0,C0_SR     # restore sr
        j     ra
        nop
        ENDFRAME(_size_cache)
        .set  reorder

```

In a properly initialized cache, every cache entry is either invalid or correctly corresponds to a memory location, and also contains correct parity. Again, the sample code shown is from IDT/sim. The code works as follows:

- Check that SR bit PZ is cleared to zero (1 disables parity; the R3071 and R3081 contain parity bits, and thus PZ=1 could cause the caches to be initialized improperly).
- Isolate the D-cache, swap to access the I-cache.
- For each word of the cache: first write a word value (writing correct tag, data and parity), then write a byte (invalidating the line).

Note that for an I-cache with 4 words per line this is inefficient; it would be enough to write just one byte in the line to invalidate the entry. Unless the system uses the invalidate routine often it doesn't seem worth the trouble.

```

FRAME(flush_cache,sp,0,ra)
        lw    t1,icache_size
        lw    t2,dcache_size
        .set  noreorder
        mfc0  t3,C0_SR     # save SR
        nop
        and   t3,~SR_PE   # dont inadvertently clear PE
        beq   t1,zero,_check_dcachesh if no i-cache check d-cache
        nop
        li    v0,SR_ISC|SR_SWC# disable intr, isolate and swap
        mtc0  v0,C0_SR
        li    t0,KOBASE
        .set  reorder
        or    t1,t0,t1

1:      sb    zero,0(t0)

```

```

sb    zero,4(t0)
sb    zero,8(t0)
sb    zero,12(t0)
sb    zero,16(t0)
sb    zero,20(t0)
sb    zero,24(t0)
addu  t0,32
sb    zero,-4(t0)
bne   t0,t1,1b
/*
 * flush data cache
 */
_check_dcachel:
li    v0,SR_ISC    # isolate and swap back caches
.set  noreorder
mtc0  v0,C0_SR
nop
beq   t2,zero,_flush_done
.set  reorder
li    t0,KOBASE
or    t1,t0,t2

1:    sb    zero,0(t0)
sb    zero,4(t0)
sb    zero,8(t0)
sb    zero,12(t0)
sb    zero,16(t0)
sb    zero,20(t0)
sb    zero,24(t0)
addu  t0,32
sb    zero,-4(t0)
bne   t0,t1,1b

.set  noreorder
_flush_done:
mtc0  t3,C0_SR    # un-isolate, enable interrupts
.set  reorder
j     ra
ENDFRAME(flush_cache)

```

## Invalidation

Invalidation refers to the act of setting specified cache lines to contain no valid references to main memory, but to otherwise be consistent (e.g. valid parity). Software needs to invalidate:

- the D-cache when memory contents have been changed by something other than store operations from the CPU. Typically this is done when some DMA device is reading into memory.
- the I-cache when instructions have been either written by the CPU or obtained by DMA. The hardware does nothing to prevent the same locations being used in the I- and D-cache; and an update by the processor will not change the I-cache contents.

Note that the system could be constructed to use unmapped accesses to those variables shared with a DMA device; the only difference is in performance. In general small areas where DMA is frequent compared to CPU activity should be mapped uncached; and larger areas where CPU activity predominates should be invalidated by the driver at appropriate points. Bear in mind that invalidating a word of data in the cache is faster (probably 4-7 times faster) than an uncached load.

To invalidate the cache:

- Figure out the address range to invalidate. Invalidating a region larger than the cache size is a waste of time.

- isolate the D-cache. Once it is isolated, the system must insure at all costs against an exception (since the memory interface will be temporarily disabled). Disable interrupts and ensure that software which follows cannot cause a memory access exception;
- to work on the I-cache, swap the caches;
- write a byte value to each cache line in the range;
- (unswap and) unisolate.

The invalidate routine is normally executed with its instructions cacheable. This sounds like a lot of trouble; but in fact shouldn't require any extra steps to run cached. An invalidation routine in uncached space will run 4-10 times slower.

Again, the example code fragment shown is taken from IDT/sim:

```

/*
** clear_cache(base_addr, byte_count)
** flush portion of cache
*/
FRAME(clear_cache,sp,0,ra)

        /*
        * flush instruction cache
        */
        lw      t1,icache_size
        lw      t2,dcache_size
        .set    noreorder
        mfc0    t3,C0_SR      # save SR
        and     t3,~SR_PE    # dont inadvertently clear PE
        nop
        nop
        li      v0,SR_ISC|SR_SWC# disable intr, isolate and swap
        mtc0    v0,C0_SR
        .set    reorder
        bltu    t1,a1,1f      # cache is smaller than region
        move    t1,a1
1:      addu    t1,a0          # ending address + 1
        move    t0,a0

        sb      zero,0(t0)
        sb      zero,4(t0)
        sb      zero,8(t0)
        sb      zero,12(t0)
        sb      zero,16(t0)
        sb      zero,20(t0)
        sb      zero,24(t0)
        addu    t0,32
        sb      zero,-4(t0)
        bltu    t0,t1,1b

        /*
        * flush data cache
        */

        .set    noreorder
        nop
        li      v0,SR_ISC    # isolate and swap back caches
        mtc0    v0,C0_SR
        nop
        .set    reorder
        bltu    t2,a1,1f      # cache is smaller than region
        move    t2,a1
1:      addu    t2,a0          # ending address + 1
        move    t0,a0

1:      sb      zero,0(t0)
        sb      zero,4(t0)
        sb      zero,8(t0)
        sb      zero,12(t0)

```

```

sb    zero,16(t0)
sb    zero,20(t0)
sb    zero,24(t0)
addu  t0,32
sb    zero,-4(t0)
bltu  t0,t2,1b

.set  noreorder
mtc0  t3,C0_SR    # un-isolate, enable interrupts
.set  reorder
j     ra
ENDFRAME(clear_cache)

```

## Testing and probing

During test, debug or when profiling, it may be useful to build up a picture of the cache contents. Software cannot read the tag value directly, but, for a valid line, can determine the tag value by exhaustive search:

- isolate the cache;
- load from the cache line at each possible line start address (low order bits fixed, high order bits ranging over physical memory which exists in the system). After each load consult the CM bit in *SR*, which will be “0” only when the tag value matches.

This takes a long time by computer terms; but to fully search a 1K D-cache with 4Mbytes of cacheable physical memory on a 20Mhz processor will take only a couple of seconds, and will provide very valuable debugging information. IDT/sim provides this capability.

## Configuration (R3041/71/81 only)

The R3041, R3071, and R3081 processors allow the programmer to make choices about the cache by setting fields in the *Config* register:

- *Cache refill burst size (R3041/71/81)*: by default the R3041 refills only 1 word in the D-cache on a cache miss; but software can program it to use 4-word burst reads instead, by setting the *Config* DBR bit. The bit can be changed at any time, without needing to invalidate the cache.

The refill of R3071 and R3081 processors can be configured by hardware at reset-time, but software can override that choice.

This support is provided in the hope of enhancing performance. The proper selection for a given system will depend on both the hardware and the application. Some systems may find an advantage in “toggling” the bit for various portions of the software. In general, the proper burst size selection can be determined as follows:

Burst reads make most sense when the memory is capable of returning a burst of data significantly faster than it can return 4 individual words. Many DRAM systems are like this; most ROM and static RAM memories are not. Similarly, data accessed from narrow memory ports should rarely be configured for a multi-word burst.

If programs tend to access memory sequentially (working up or down a large array, for example) then the burst refill will offer a very useful degree of data prefetch, and performance will be enhanced. If cache access is more random, the burst refill may actually reduce performance (since it involves overwriting cached data with memory data the program may never use).

As a general rule, the bigger the D-cache, the smaller the penalty for burst refills.

- *Bigger I-cache in exchange for smaller D-cache (R3071/81)*: the R3081 cache can be organized either with both I-cache and D-cache 8Kbytes in size, or with a 16Kbyte I-cache and 4Kbyte D-cache. The configuration is programmed using the AC bit in the *Config* register.

After changing the cache configuration both caches should be re-initialized, while running uncached. This means that most systems will not dynamically reconfigure the caches.

Which configuration is best for a given system is mainly dependent on the software. Cache effects are extremely hard to predict, and it is recommended that both configurations be tried and measured, while running as much of the real system as possible.

As a general rule: with large applications (like in a big OS) the big I-cache will probably be best. If the system spends most of its time manipulating lots of data from tight program loops, the big D-cache may be better.

## WRITE BUFFER

The write-through cache common to all R30xx family CPUs can be a big performance bottleneck. In the average C program only about 10% of instructions are stores, but these accesses tend to come in bursts; for example, when a function prologue saves a few registers.

DRAM memory frequently has the characteristic that the first write of a group takes quite a long time (5-10 clocks typical on these CPUs), and subsequent ones are relatively fast so long as they follow quickly.

If the CPU simply waits for all writes to complete, the performance hit will be significant. So the R30xx provides a *write buffer*, a FIFO store which keeps a number of entries each containing both data to be written, and the address at which to write it. The 4-entry queue provided by R30xx family CPUs is efficient for well-tuned DRAM.

In general, the operation of the write buffer is completely transparent to software. Occasionally, the programmer needs to be aware of what is happening:

- *Timing relations for IO register accesses:* When software performs a store to write an IO register, the store reaches memory after a small, but indeterminate, delay. Some consequences are:
  - other communication with the IO system (e.g. interrupts) may happen more quickly – for example, the CPU may get an interrupt from a device “after” it has been programmed to generate no interrupts.
  - if the IO device needs some time to recover after a write the program must ensure that the write buffer FIFO is empty before counting out that time period.
  - at the end of interrupt service, when writing to an IO device to clear the interrupt it is asserting, software must insure that the command is actually written to the device, and that it has had to respond, before re-enabling that interrupt; otherwise, spurious interrupts may be signalled.

In these cases the programmer must ensure that the CPU waits while the write buffer empties. It is good practice to define a subroutine which does this job; it is traditionally called *wbflush()*. Hints on implementing this function are provided later in this chapter.

On CPUs outside the R30xx family, even stranger things can happen:

- *Reads overtaking writes:* a load instruction (uncached or missing in the cache) executed while the write buffer FIFO is not empty gives the CPU a choice: should it finish off the write, or use the memory interface to fetch data for the load?

The R3041, R3051, R3052 and R3081 all have the same rule, which avoids potential problems: the write buffer is emptied before the load occurs.

Although it seems tempting to instead implement a scheme which checks for conflicts, and allows the read to progress if no write buffer entry matches the read target address, such a scheme does not avoid the possible system problems. Specifically, writes to locations which

may have side effects (e.g. semaphores, IO registers, etc.), are not detected under such a scheme, and can cause great headaches to the programmer.

- *Byte gathering*: some write buffers watch for partial-word writes within the same memory word, and will combine those partial writes into a single operation. This is not done by any current R30xx family CPU, because such operation would pose problems with IO register writes.

### Implementing *wbflush()*

IDT R30xx family CPUs enforce strict write priority (all pending writes retired to memory before main memory is read). Thus, implementing *wbflush()* is as simple as implementing an uncached load (e.g. from the boot PROM vector). This will stall the CPU until the writes have finished, and the load finished too. Alternately, the overhead can be minimized by performing an uncached load from the fastest memory available in the system.

The code fragment below shows an implementation of *WbFlush*, taken from IDT/sim:

```

/*
** wbflush() flush the write buffer - this is specific for each
hardware
** configuration.
*/
FRAME(wbflush,sp,0,ra)
    .set noreorder

    lw    t0,wbflush#read an uncached memory location
    j     ra
    nop
    .set reorder
ENDFRAME(wbflush)

```

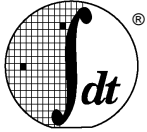

Integrated Device Technology, Inc.

**MEMORY MANAGEMENT AND THE TLB**

Some R30xx family processors (“E” versions) have on-chip memory management hardware. This provides a mechanism for dynamically translating program addresses in the *kuseg* and *kseg2* regions. The key piece of hardware is the “TLB†”.

The memory management is *paged*: with a fixed page size of 4Kbytes. The low-order 12 bit of the program address are used directly as the low order bits of the physical address, so address translation operates in 4K chunks.

The TLB is a 64-entry *associative memory*. Each entry in an associative memory consists of a key field and a data field; when presented with a key, the memory returns the data of any entry where the key matches.

In the R30xx family, the TLB is referred to as “fully-associative”; this emphasizes that all keys are really compared with the input value in parallel.

The TLB’s key field contains two sections:

- *Virtual page number*: (VPN) this is just a program address with the low 12 bits cut off, since the low-order bits don’t participate in the translation process.
- *Address Space Identifier*. (ASID): this is a magic number used to stamp translations, and (optionally) is compared with an extended part of the key. Why?

In multi-tasking systems it is common to have all user-level tasks executing at the same sort of program addresses (though of course they are using different physical addresses); they are said to be using different *address spaces*. So translation records for different tasks will often share the same value of “VPN”. If the TLB mechanism was not supported with an ASID, when the OS switches from one task to another, it would have to find and invalidate all TLB translations relating to the old task’s address space, to prevent them from being erroneously used for the new one. This would be desperately inefficient.

Instead, the OS assigns a 6-bit unique code to each task’s distinct address space. During normal running this code is kept in the ASID field of the *EntryHi* register, and is used together with the program address to form the lookup key; so a translation with an ASID code which doesn’t match is quietly ignored.

Since the ASID is only 6 bits long, OS software does have to lend a hand if there are ever more than 64 address spaces in concurrent use; but it probably won’t happen too often. In such a system, new tasks are assigned new ASIDs until all 64 are assigned; at that time, all tasks are flushed of their ASIDs “de-assigned” and the TLB flushed; as each task is re-entered, a new ASID is given. Thus, ASID flushing is relatively infrequent.

The TLB data field includes:

- *Physical frame number* (PFN): the physical address with the low 12 bits cut off. In an address translation, the VPN bits are replaced by the corresponding PFN bits to form the true physical address.
- *Cache control bit* (N): set 1 to make the page uncacheable.

---

† This is an acronym for “translation lookaside buffer”, which is a look-up table of virtual to physical address translations.



- *Write control bit (D)*: set 1 to allow stores to this page to happen. The “D” comes from this being called the “dirty bit”; a later section on “Simulating dirty bits” describes a typical use for these bits.
- *Valid bit (V)*: set 0 to make this entry usable. This seems pretty pointless; why have a record loaded into the TLB if the translation is not usable? But an access to an invalid page produces a different trap from a TLB refill exception, so making a page invalid means that some strange conditions can be made to take a different trap, which does not have to be handled by the superfast refill code.
- *Global bit (G)*: set to disable the ASID-matching scheme, allowing an OS to map some program addresses to the same physical address for all tasks; it can be useful to have some corner of each address space mapped to the same physical locations. Sharp-eyed or experienced readers will notice that this means that the global bit is really more like part of the key than part of the data; the distinction tends to get blurred in associative memories.

Translating an address is now simple, and goes like this:

- *CPU generates a program address*: either for an instruction fetch, a load or a store, in one of the translated address regions. The low 12 bits are separated off, and the resulting VPN together with the current value of the ASID field in *EntryHi* used as the key to the TLB.
- *TLB matches key*: selecting the matching entry. The PFN is glued to the low-order bits of the program address to form a complete physical address.
- *Valid?*: the V and D bits are consulted. If it isn’t valid, or a store is being attempted with D cleared, the CPU takes a trap. As with all translation traps, the *BadVaddr* register will be filled with the offending program address and TLB registers *Context* and *EntryHi* pre-filled with relevant information. The system software can use these registers to obtain data for exception service.
- *Cached?*: if the N bit is set the CPU looks in the cache for a copy of the physical location’s data; if it isn’t there it will be fetched from memory and a copy left in the cache. Where the C bit is clear the CPU neither looks in nor refills the cache.

Of course, there are only 64 entries in the TLB, which can hold translations for a maximum of 256 Kbytes of program addresses. This is far short of enough for most systems. The TLB is almost always going to be used as a software-maintained “cache” for a much larger set of translations.

When a program address lookup in the TLB fails, a *TLB refill* trap is taken. System software has the job of:

- figuring out whether there is a correct translation; if not the trap will be dispatched to the software which handles address errors.
- if there is a correct translation, constructing a TLB entry which will implement it;
- if the TLB is already full (and it almost always is full in running systems), selecting an entry which can be discarded;
- writing the new entry into the TLB.

See below for how this can be tackled; but note here that although special CPU features help out with one particular class of implementations, the software can refill the TLB any way it likes.

Register Mnemonic	Description	CPO reg no
EntryHi	Together these registers hold a TLB entry. All reads and writes to the TLB must be staged through them. EntryHi also remembers the current ASID.	10
EntryLo		2
Index	Determines which TLB entry will be read/written by appropriate instructions	0
Random	pseudo-random value (actually a free-running counter) used by a <i>tlbwr</i> to write a new TLB entry into a “randomly” selected location.	1
Context	Convenience register provided to speed up the processing of TLB refill traps. The high-order bits are read/write; the low-order 21 bits reflect the <i>BadVaddr</i> value. (The register is designed so that, if the system uses the “favored” arrangement of memory-held copies of memory translation records, it will be setup by a TLB refill trap to point to the memory location of the record needed to map the offending address. This speeds up the process of finding the current memory mapping, and arranging EntryHi/Lo properly).	4

**Table 6.1. CPU control registers for memory management**

## MMU registers described

### EntryHi, EntryLo

31	12	11	6	5	0
VPN			ASID		0

EntryHi Register (TLB key fields)

**Figure 6.1. EntryHi and EntryLo register fields**

31	12	11	10	9	8	7	0
PFN			N	D	V	G	0

EntryLo Register (TLB data fields)

**Figure 6.2. EntryHi and EntryLo register fields**

These two registers represent a TLB entry, and are best considered as a pair. Fields in *EntryHi* are:

- *VPN*: “virtual page number”, the high-order bits of a program address. On a refill exception this field is set up automatically to match the program address which could not be translated. To write a different TLB entry, or attempt a TLB probe, software must set it up “manually”.
- *ASID*: “address space identifier”, normally left holding the OS’ value for the current address space. This is not changed by exceptions. Most software systems will deliberately write this field only to setup the current address space.

However, software must be careful when using *tlbr* to inspect TLB entries; the operation overwrites the whole of *EntryHi*, so software needs to restore the correct current ASID value afterwards.

Fields in *EntryLo* are:

- *PFN*: the high-order bits of the physical address to which values matching *EntryHi*'s VPN will be translated.
- *N*: “noncacheable”; 0 to make the access cacheable, 1 for uncacheable.
- *D*: “dirty”, but really a write-enable bit. 1 to allow writes, 0 and any store using this translation will be trapped.
- *V*: “valid”, if 0 any address matching this entry will cause an exception.
- *G*: “global”. When the G bit in a TLB entry is set, that TLB entry will match solely on the VPN field, regardless of whether the TLB entry's ASID field matches the value in *EntryHi*.
- *Fields called “0”*: these fields always return zero; but unlike many reserved fields, they do not need to be written as zero (nothing happens regardless of the data written). This is important; it means that the memory-resident data which is used to generate *EntryLo* when refilling the TLB can contain some software-interpreted data in these fields, which the TLB hardware will ignore without the need to spend precious CPU cycles masking it.

### Index

31	30		14	13		8	7		0
P	×			Index			×		

**Figure 6.3. Fields in the Index register**

The “P” field is set when a *tlbp* instruction (tlb probe, used to see if the TLB can translate a particular VPN) failed to find a valid translation; since it is the top bit it appears to make the 32-bit value negative, which is easy to test for.

### Random

31		14	13		8	7		0
×			Random				×	

**Figure 6.4. Fields in the Random register**

Most systems never have to read or write the *Random* register, shown as Figure 6.4, “Fields in the Random register”, in normal use; but it may be useful for diagnostics. The hardware initializes the *Random* field to its maximum value (63) on reset, and it decrements every clock period until it reaches 8, when it wraps back to 63 and starts again.

### Context

31		21	20		2	1	0
PTEBase			Bad VPN				0

**Figure 6.5. Fields in the Context Register**

- *PTEBase*: a location which just stores what is put in it. In the “standard” refill handler, this will be the high-order bits of the (1Mbyte aligned) starting address of a memory-resident page table.
- *Bad VPN*: following an addressing exception this holds the high-order bits of the address; exactly the same as the high-order bits of *BadVaddr*. However, if the system uses the “standard” TLB refill

exception handling code the 32-bit value formed by *Context* is directly usable as a pointer to the memory-resident page table, considerably shortening the refill exception code.

- *Fields marked 0*: can be written with any value, but they will always read zero.

### MMU control instructions

**tlbr**            -            *Read TLB entry at index*

**tlbwi**           -            *Write TLB entry at index*

The above two instructions move MMU data between the TLB entry selected by the *Index* register and the *EntryHi* and *EntryLo* registers.

**tlbwr**           -            *Write TLB entry selected by Random*

copies the contents of *EntryHi* & *EntryLo* into the TLB entry indexed by the *random* register. This saves time when using the recommended random replacement policy. In practice, *tlbwr* will be used to write a new TLB entry in a TLB refill exception handler; *tlbwi* will be used anywhere else.

**tlbp**            -            *TLB lookup*

searches (probes) the TLB for an entry whose virtual page number and ASID matches those currently in *EntryHi*, and stores the index of that entry in the *index* register (*index* is set to a negative value if nothing matches). If more than one entry matches, anything might happen. Note that *tlbp* does not fetch data from the TLB. The instruction following a *tlbp* must not be a load or store.

### Programming interface to the TLB

TLB entries are set up by writing the required fields into *EntryHi* and *EntryLo* and using a *tlbwr* or *tlbwi* instruction to copy that entry into the TLB proper.

When handling a TLB refill exception, *EntryHi* has been set up automatically, with the current ASID and the required VPN.

Be very careful not to create two entries which will match the same program address/ASID pair. If the TLB contains duplicate entries an attempt to translate such an address, or probe for it, produces a fatal “TLB shutdown” condition (indicated by the TS bit in *SR* being set). It can be cleared only by a hardware reset.

System software often won’t need to read TLB entries at all. But if necessary, software can find the TLB entry matching some particular program address using *tlbp* to setup the *Index* register. Don’t forget to save *EntryHi* and restore it afterwards because its ASID field is likely to be important.

Use a *tlbr* to read the TLB entry into *EntryHi* and *EntryLo*.

### How refill happens

When a program makes an access in *kuseg* or *kseg2* to a page for which no translation record is present, the CPU takes a TLB refill exception. The assumption is that system software is maintaining a large number of page translations and is using the TLB as a cache of recently-used translations; so the refill exception will normally be handled by finding a correct translation, installing it, and returning to user code.

In “CISC” CPUs the TLB is a cache (usually implemented by microcode), and the CPU automatically reads memory-resident “page tables” whose structure is part of the CPU architecture.

In the MIPS architecture software is fast enough, and offers greater flexibility.

To save time on user-program TLB refill exceptions (which will happen frequently in a “big” OS):

- refill exceptions on *kuseg* program addresses are vectored through a low-memory address used for no other exception;

- special exception rules permit the kuseg refill handler to risk a nested TLB refill exception on a kseg2 address.

The problem is that before an exception routine can itself suffer an exception it must first save the previous program state, represented by the *EPC* return address and some *SR* bits. This is helped out by a hardware feature and a software convention:

- a) the *KUo*, *IEo* bits in the status register act as a third level of the processor-state stack, so that the CPU state already saved as a result of the kuseg refill exception can be preserved during the nested exception.
- b) The kuseg refill handler copies *EPC* into the *k1* register; the general exception code and kseg2 refill handler are then careful to preserve its value, enabling a clean return.

Refill exceptions on kseg2 addresses are expected to be rare enough that it will not matter if they share in the overhead of the “all other exceptions” entry point. However, once software determines the type of exception the handling is similar.

### Using ASIDs

By setting up TLB entries with a particular ASID setting and with the *EntryLo G* bit zero, those entries will only ever match a program address when the CPU’s *ASID* register is set the same. This allows software to map up to 64 different address spaces simultaneously, without requiring that the OS clear out the TLB on a context change.

In typical usage, new tasks are assigned an “un-initialized” ASID. The first time the task is invoked, it will presumably miss in the TLB, allowing the assignment of an ASID. If the system does run out of new ASIDs, it will flush the TLB and mark all tasks as “new”. Thus, as each task is re-entered, it will be assigned a new ASID. This sequence is expected to happen infrequently if ever.

### The Random register and wired entries

The hardware offers no way of finding out which TLB entries have been used most recently. When the system needs to replace a mapping dynamically (using the TLB as a cache) the only practicable strategy is to replace an entry at random. The CPU makes this easy by maintaining the *Random* register, which counts (down) with every processor cycle.

However, it is often useful to have some TLB entries which are guaranteed to stay there unless explicitly removed. These may be useful to map pages which are known to be required very often; they are critical because they allow the system to map pages and *guarantee* that no refill exception will be generated on them.

The stable TLB entries are described as “wired” and on R30xx family CPUs consist of TLB entries 0 through 7. There is nothing special about these entries; the magic is in the *Random* register, which never takes values 0-7; it cycles directly from 63 down to 8 before reloading with 63. So conventional random replacement leaves TLB entries 0 through 7 unaffected, and entries written there will stay until explicitly removed.

### Memory translation - setup

The following code fragment initializes the TLB to ensure no match on any kuseg or kseg2 address. This is important, and is preferable to initializing with all “0”s (which is a kuseg address, and which would cause multiple matches if referenced):

```
LEAF(mips_init_tlb)
    mfc0    t0,C0_ENTRYHI # save asid
    mtc0    zero,C0_ENTRYLO# tlblo = !valid
    li     a1,NTLBID<<TLBIDX_SHIFT # index
    li     a0,KSEG1_BASE # tlbhi = impossible vpn

    .set noreorder
```

```

1:      subu   a1,1<<TLBIDX_SHIFT
        mtc0  a0,C0_ENTRYHI
        mtc0  a1,C0_INDEX
        bnez  a1,1b
        tlbwi                    # BDSLOT
        .set  reorder

        mtc0  t0,C0_ENTRYHI # restore asid
        j     ra
END(mips_init_tlb)

```

### TLB exception sample code

There are two examples provided. The first is written in C, and assumes that the OS provides a low-level handler which saves state, including copying the exception registers into an “xcpcontext” structure, and dispatches through programmable tables to a C routine:

#### Basic exception handler

```

/* install C exception handler for TLB miss exception */
xcption (XCPTTLBMISS, tlbmiss);

...

#define VMPGSHIFT12 /* convert address to page number */

tlbmiss (int code, struct xcptcontext *xcp)
{
    unsigned pfn = map_virt_to_phys (xcp->vaddr) >> VMPGSHIFT;
    unsigned vpn = xcp->vaddr >> VMPGSHIFT;
    unsigned asid = 0;

    /* write a random tlb (entryhi, entrylo) pair */
    /* mark it valid, global, uncached, and not writable/dirty */
    r3k_tlbwr ((vpn <<TLBHI_VPNSHIFT) | (asid <<TLBHI_PIDSHIFT),
               (pfn <<TLBLO_PFNSHIFT) | TLB_V | TLB_G | TLB_N);
    return 0;
}

```

The macro (or routine) `map_virt_to_phys()` which does the actual work, will be system dependent.

#### Fast kuseg refill from page table

This routine implements the translation mechanism which the MIPS architects had in mind for user addresses in a Unix-like OS. It relies upon building a page table in memory, for each address space. The page table consists of a linear array of one-word entries, indexed by the VPN, whose format is matched to the bitfields of the *EntryLo* register.

Such a scheme is simple, but has one problem. Since each 4Kbytes of user address space takes 4 bytes of table space, the entire 2Gbyte user space needs a 2Mbyte table, which is a large chunk of data. Moreover, most user address spaces are used at the bottom (for code and data) and at the top (for a downward growing stack) with a huge gap in between. The solution adopted is inspired by Digital’s VAX architecture, and is to locate the page table itself in virtual memory, in the kseg2 region. This neatly solves two problems at once:

- saves physical memory, since the unused gap in the middle of the page table will never be referenced.
- provides an easy mechanism for remapping a new user page table when changing context, without having to find enough virtual addresses in the OS to map all the page tables at once.

The MIPS architecture gives positive support to this mechanism in the form of the *Context* register. If the page table starts at a 1Mbyte boundary (since it is in virtual memory, any gap created won't use up physical memory space) and the *Context* PTEBase field is filled with the high-order bits of the page table starting address, then following a user refill exception the *Context* register will contain the address of the entry needed for the refill, with no further calculation.

The resulting routine looks like this:

```

        .set    noreorder
        .set    noat
xcpt_vecfastutlb:
    mfc0    k1,C0_CONTEXT
    mfc0    k0,C0_EPC    # mfc0 delay slot
    lw     k1,0(k1)    # may double fault (k0 = orig EPC)
    nop
    mtc0    k1,C0_ENTRYLO
    nop
    tlbwr
    jr     k0
    rfe
xcpt_endfastutlb:
    .set    at
    .set    reorder

```

## Simulating dirty bits

An operating system providing a page for an application program to use often wants to keep track of whether that page has been modified since the OS last obtained it (perhaps from disc or network) or saved a copy of it. Non-modified pages are cheap to discard, since they can easily be replaced if required.

In OS parlance such modified pages are called “dirty” and the OS must take care of them until the application program exits, or the dirty page saved away to backing store.

To help out with this process it is common for CISC CPUs to maintain a bit in the memory-resident page table indicating that a write operation to the page has occurred.

The MIPS CPU does not directly implement this feature, even in the TLB entries. The “D” bit of the page table (found in the *EntryLo* register) is a write-enable, and is of course used to flag read-only pages.

To simulate “dirty” bits, the OS should mark new pages (in the page table) with D clear. Since the CPU will consider that page “write-protected”, a trap will result when the page is first modified; system software can identify this as a legitimate write but use the event to set a “modified” bit in the memory resident tables (it will also want to set the D bit in the TLB entry so that the write can proceed, but since TLB entries are randomly and unpredictably replaced this would be useless as a way of remembering the modified state).

## USE OF TLB IN DEBUGGING

In systems which do not require the TLB for normal execution, it still may prove useful during initial system debug. Although its use for this purpose will be system dependent, some general ideas follow:

- To hit a “trap” when software “wanders into the weeds” (e.g. makes mysterious references or instruction fetches from strange memory locations), software can initialize the TLB with only those mappings which correspond to valid program addresses. Thus, a TLB trap will occur in the exact instruction which makes the reference, and full processor state will be visible.

- To identify which task or subroutine is modifying a particular memory location, that location can be “write-protected”, generating a trap on store.

The TLB may have one additional consequence in debugging. In a virtual memory OS, the actual physical memory location of a task (or even of portions of the OS) can move around as memory is paged. This can make low-level debugging difficult, since one cannot set a logic analyzer to trap on the right physical address.

To resolve this situation, software can utilize a system specific “NOP” instruction. Recall that updates to the zero register \$0 will be ignored; software can use this fact to generate a specific NOP instruction for the reference in question; the logic analyzer can then be used to search for this particular instruction fetch, correctly identifying the current virtual to physical mapping.

## TLB MANAGEMENT UTILITIES

The following routines implement the most common TLB management functions. These code fragments are taken from IDT/sim.

```

/* Functions dealing with the TLB.
** Use resettlb() defined here and called from excepthand.c
** to initialize tlb.
*/

/*
** idttlb.s - fetch the registers associated with and the
** contents
** of the tlb.
**
*/
#include "iregdef.h"
#include "idtcpu.h"
#include "idtmon.h"

        .text

/*
** ret_tlblo -- returns the 'entrylo' contents for the TLB
** 'c' callable - as ret_tlblo(index) - where index is the
** tlb entry to return the lo value for - if called from
** assembly
** language then index should be in register a0.
*/
FRAME(ret_tlblo,sp,0,ra)
        .set    noreorder
        mfc0   t0,C0_SR      # save sr
        nop
        and    t0,~SR_PE    # dont inadvertantly clear PE
        mtc0   zero,C0_SR   # clear interrupts
        mfc0   t1,C0_TLBHI  # save pid
        sll   a0,TLBINX_INXSHIFT# position index
        mtc0   a0,C0_INX    # write to index register
        nop
        tlbw                    # put tlb entry in entrylo and
hi
        nop
        mfc0   v0,C0_TLBLO  # get the requested entry lo
        mtc0   t1,C0_TLBHI  # restore pid
        mtc0   t0,C0_SR     # restore status register
        j     ra
        nop
ENDFRAME(ret_tlblo)

/*
** ret_tlbhi -- return the tlb entry high content for tlb entry
** index

```



```

/*
FRAME(ret_tlbhi,sp,0,ra)
    mfc0    t0,C0_SR      # save sr
    nop
    and     t0,~SR_PE
    mtc0    zero,C0_SR    # disable interrupts
    mfc0    t1,C0_TLBHI   # save current pid
    sll    a0,TLBINX_INXSHIFT# position index
    mtc0    a0,C0_INX     # drop it in C0 register
    nop
    tlbr
    nop
    mfc0    v0,C0_TLBHI   # to return value
    mtc0    t1,C0_TLBHI   # restore current pid
    mtc0    t0,C0_SR     # restore sr
    j      ra
    nop
ENDFRAME(ret_tlbhi)

/*
** ret_tlbpid() -- return tlbpid contained in the current entry hi
*/
FRAME(ret_tlbpid,sp,0,ra)
    mfc0    v0,C0_TLBHI   # fetch tlb high
    nop
    and     v0,TLBHI_PIDMASK# isolate and position
    srl    v0,TLBHI_PIDSHIFT
    j      ra
    nop
ENDFRAME(ret_tlbpid)

/*
** tlbprobe(address, pid) -- probe the tlb to see if address is
currently
**                               mapped
**    a0 = vpn - virtual page numbers are 0=0 1=0x1000,
2=0x2000...
**                               virtual page numbers for the r3000 are in
**                               entry hi bits 31-12
**    a1 = pid - this is a process id ranging from 0 to 63
**             this process id is shifted left 6 bits and or'ed
into
**             the entry hi register
**    returns an index value (0-63) if successful -1 -f not
*/
FRAME(tlbprobe,sp,0,ra)
    mfc0    t0,C0_SR      /* fetch status reg */
    and     a0,TLBHI_VPNMASK/* isolate just the vpn */
    and     t0,~SR_PE     /* don't inadvertently clear pe */
    mtc0    zero,C0_SR
    mfc0    t1,C0_TLBHI
    sll    a1,TLBHI_PIDSHIFT/* position the pid */
    and     a1,TLBHI_PIDMASK
    or     a0,a1          /* build entry hi value */
    mtc0    a0,C0_TLBHI
    nop
    tlbpr
    nop
    mfc0    v1,C0_INX
    li     v0,-1
    bltz   v1,1f
    nop
    sra    v0,v1,TLBINX_INXSHIFT/* get index positioned for
return */
1:
    mtc0    t1,C0_TLBHI   /* restore tlb hi */
    mtc0    t0,C0_SR     /* restore the status reg */
    j      ra

```

```

        nop
    ENDFRAME(tlbprobe)

/*
** resettlb(index) Invalidate the TLB entry specified by index
*/
FRAME(resettlb,sp,0,ra)
    mfc0    t0,C0_TLBHI    # fetch the current hi
    mfc0    v0,C0_SR      # fetch the status reg.
    li      t2,KOBASE&TLBHI_VPNMASK
    and     v0,~SR_PE     # dont inadvertantly clear PE
    mtc0    zero,C0_SR
    mtc0    t2,C0_TLBHI   # set up tlbhi
    mtc0    zero,C0_TLBLO
    sll     a0,TLBINX_INXSHIFT
    mtc0    a0,C0_INX
    nop
    tlbwi                                # do actual invalidate
    nop
    mtc0    t0,C0_TLBHI
    mtc0    v0,C0_SR
    j      ra
    nop
ENDFRAME(resettlb)

/*
** Setup TLB entry
**
** map_tlb(index, tlbhi, phypage)
**     a0 = TLB entry index
**     a1 = virtual page number and PID
**     a2 = physical page
**
*/
FRAME(map_tlb,sp,0,ra)

    sll     a0,TLBINX_INXSHIFT
    mfc0    v0,C0_SR      # fetch the current status
    mfc0    a3,C0_TLBHI   # save the current hi
    and     v0,~SR_PE     # dont inadvertantly clear parity

    mtc0    zero,C0_SR
    mtc0    a1,C0_TLBHI   # set the hi entry
    mtc0    a2,C0_TLBLO   # set the lo entry
    mtc0    a0,C0_INX     # load the index
    nop
    tlbwi                                # put the hi/lo in tlb entry
indexed
    nop
    mtc0    a3,C0_TLBHI   # put back the tlb hi reg
    mtc0    v0,C0_SR     # restore the status register
    j      ra
    nop
ENDFRAME(map_tlb)

/*
** Set current TLBPID. This assumes PID is positioned correctly in
reg.
**
**
*/
FRAME(set_tlbpid,sp,0,ra)

    sll     a0,TLBHI_PIDSHIFT
    mtc0    a0,C0_TLBHI
    j      ra
    nop
    .set   reorder
ENDFRAME(set_tlbpid)

```

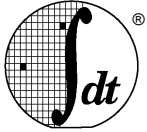

## STARTING UP

In terms of its effect on the CPU, “reset” is almost the same as an exception. Following reset, *EPC* points to the instruction being executed when reset was detected, and most registers are unchanged. However, reset disrupts normal operation and a register being loaded or a cache location being stored to or refilled at the moment reset occurred may be trashed.

It is quite possible to use the preservation of state through reset to implement some useful post-mortem debugging, but the system hardware engineer needs to help; the CPU cannot tell whether reset occurred to a running system or from power-up. This chapter will focus on starting up the system from scratch.

The CPU responds to reset with a jump to program location `0xBFC0 0000`. This is physical address `0x1FC0 0000` in the uncached *kseg1* region.

Following reset, enough state is defined so that the CPU can execute uncached instructions. Virtually nothing else is defined:

- Only a few state bits are guaranteed in *SR*; these are that the CPU is in kernel mode ( $KUc = 0$ ), interrupts are disabled ( $IEc = 0$ ), exceptions will vector through the uncached entry points ( $BEV = 1$ ); the *TS* bit is guaranteed in R30xx family CPUs (it will be cleared to 0 if the CPU has MMU hardware (“E” versions), set to 1 for base versions).
- The D-cache may or may not be isolated ( $IsC = 1$ ), so software cannot rely on data loads and stores working, even to uncached space, without first initializing this field to ‘0’.
- The cache may be in a random, undefined state; so a cached load might return uninitialized cache data without reading memory.
- For “E” versions, the TLB may be in a random state and *must not be accessed or referenced* until initialized (the hardware has only minimal protection against the possibility that there are duplicate matches in the TLB, and the result will be a TLB shutdown which can be amended only by a further reset).

The traditional start-up sequence is:

- branch to the main ROM code. Why do a branch now?
  - a) the exception vectors must start at `0xBFC0 0100`, which wouldn’t leave enough space for start-up code to get to a “natural break”;
  - b) the branch represents a very simple test that the CPU is functioning and is successfully reading instructions. If something terrible goes wrong with the hardware, the CPU is most likely to keep fetching instructions in sequence.

Test equipment which can track the addresses of CPU reads and writes will show the CPUs uncached instruction fetches from reset; if the CPU starts up and branches to the right place, then evidence is strong that the CPU is getting mostly-correct data from the ROM.

By contrast, if the ROM software plows straight in and manipulates *SR*, strange and undiagnosable consequences may be produced by simple faults.

- Set the status register to some known and sensible state. Now software can load and store reliably in uncached space.

- Software will probably have to run using registers only until it has initialized and (most likely) run a quick check on the integrity of RAM memory. This will be slow (the CPU is still running uncached from ROM), so it may be desirable to constrain the initialization and check function to the data which the ROM program itself will use.
- The system will probably have to make some contact with the outside world (a console port or diagnostic register) so it can report any problem with the initialization process.
- Software can now assign some stack space and set up enough registers to be able to call a standard C routine.
- Now the caches can be initialized, and the CPU can be used for more strenuous tasks. Some systems can run code from ROM cached, and some can't; the CPU can only cache instructions from a memory which is capable of supplying data in 4-word bursts, and the ROM subsystem may or may not oblige.

The following start-up code is taken from IDT/sim:

```

/*
** Copyright 1989 Integrated Device Technology, Inc.
**   All Rights Reserved
**
** sample initialization (reset) code
*/

#include "excepthdr.h"
#include "iregdef.h"
#include "idtcpu.h"
#include "idtmon.h"
#include "under.h"

/*-----
**   external declarations - defined in the module shown in
**                               parenthesis
**-----
*/
.externmem_start,4 /*start loc. for mem test */
.externmem_end,4 /*end loc. for mem test */
.extern parity_error,4 /* global parity error count
(idtglobals.c) */
.extern status_base,4 /* contains value to be loaded into status
*/
/* register on startup */
.extern fp_int_line,4 /* fpu external interrupt line */
.extern fp_int_num,4 /* fpu external interrupt number */

.text
FRAME(start,sp,0,ra)
.set noreorder
li v0,SR_PE|SR_CU1#enable coproc 1 clear parity error
and set
mtc0 v0,C0_SR # state unknown on reset
mtc0 zero,C0_CAUSE# clear software interrupts

# check to see if R3041
mfc0 t0, CO_PRID
nop
li t2, 0x00000700# R3041 has rev no 0x00000700
bne t0, t2,not41

# R3041 specific initialization code here

# load appropriate values in busctrl and portsize
registers.
# disable coprocessor 1
j commcod

```

```

not41:
    # check to see if R3081

    li    t3,0xaaaa5555
    mtc1  t3, $f0      #put 0xaaaa5555 in f0
    mtc1  zero, $f1# 0 in f1
    mfc1  t0, $f0
    mfc1  t4, $f1      # read registers back
    bne   t0, t3, its51# no FPA, must be 3051(52)
    bne   t4, zer0, its51 # no FPA, must be 3051(52)

    # R3081 specific initialization code here
    j     commcod

its51:
    # R3051 specific initialization here
    # disable coprocessor 1
commcod:
    # code common to all processors
    li    v0,K1BASE # verify that ram can be accessed
    li    t0,0xaaaa5555
    sw    t0,0(v0)
    sw    zero,4(v0)# put a different pattern on bus
    lw    t1,0(v0)
    nop
    beq   t1,t0,2f# is memory accessable
/* memory not accessable, hang here, no point in proceeding */
1:      nop
        b     1b
        nop

2:      li    t0,-1
        sw    t0,8(v0)
        sw    zero,4(v0)
        lw    t1,8(v0)
        nop
        bne   t0,t1,1b
        nop
        .set  reorder
        sw    zero,parity_error# clear parity error count
        jal   initmem          # initializes sp
        jal   initialize      # initialize memory and tlb
        j     yourcode
ENDFRAME(start)

/*
** initmem -- config and init cache, clear prom bss
** clears memory between PROM_STACK-0x2000 and PROM_STACK-4
inclusive
*/
#define INITMEMFRM ((4*4)+4)
FRAME(initmem,sp, INITMEMFRM, ra)
    la    v0,_fbss # clear bss
    la    v1,end    # end of bss

    .set  noreorder
1:      sw    zero,0(v0)/* clear bss */
        bltu v0,v1,1b
        add  v0,4

/*
** Initialize stack
**
add    v1,v0,P_STACKSIZE/* end of prom stack */
sw     v1,mem_start
sub    v1,v1,(4*4)

```

```

        sw    v1,fault_stack/* top of fault stack */
        subu  sp,v1,P_STACKSIZE/4/* monitor stack top */
        subu  sp,INITMEMFRM
1:      sw    zero,0(v0)
        bltu  v0,v1,1b
        add   v0,4
        sw    ra,INITMEMFRM-4(sp)
        .set  reorder

        jal   config_cache /* determine cache sizes */
        jal   flush_cache /* flush cache */
        lw    ra,INITMEMFRM-4(sp)
        addu  sp,INITMEMFRM
        j     ra
ENDFRAME(initmem)

/*
** initialize -- initializes memory and tlb
*/
#define INITFRM ((4*4)+4)
FRAME(initialize,sp, INITFRM,ra)
    subu  sp,INITFRM
    sw    ra,INITFRM-4(sp)
    jal   init_io /* initialize io */
    jal   init_memory /* initialize memory and tlb */
    lw    ra,INITFRM-4(sp)
    addu  sp,INITFRM
    j     ra
ENDFRAME(initialize)

```

## Probing and recognizing the CPU

The *PRId* register *Imp* and *Rev* fields is useful for the first check, to differentiate the R3041 from other family members. The *Imp* field will be “2” for the R3051, R3052, R3071 and R3081 (indicating that their control register sets are identical to the R3000A), but “7” for the R3041†, which has no MMU and assigns some control register numbers differently. Diagnostic software should also make the “Rev” field visible.

Software can investigate the presence of FPA hardware. The “official” technique is to set *CU1* in *SR* to enable co-processor 1 operations, and use a *cfcl* instruction from co-processor 1 register 0, which is defined to hold the revision ID. A non-zero value in bits 15-8 indicates the presence of FPA hardware; the value “3” is standard for the FPA type which partners the R3000 CPU. Don’t forget to reset *CU1* in *SR* afterwards! A skeptical programmer will probably follow this up by checking that it is possible to store and retrieve data from the FPA registers.

The size of the on-chip caches can be determined, as described in chapter 5. The programmer can NOT assume the cache sizes based on the value of the *PRId* register; instead, the cache sizes must be explicitly measured.

The test for the presence of a TLB in an R30xx family CPU is that the *TS* bit will be clear in *SR* following a hardware reset.

It is often useful to work out the system clock rate. This can be accomplished by running a loop of known length, cached, which will take a fixed large number of CPU cycles, and comparing with “before” and “after” values of a counter which increments at known speed.

Printing out the CPU type, clock rate and cache sizes as part of a sign-on message may be useful.

---

† Actually, “7” indicates an IDT specified CP0 architecture. When the *IMP* field matches ‘7’, the revision field is used to distinguish among incompatible CP0’s. In the case of the R3041, the *REV* field will match “0”.

## Bootstrap sequences

Start-up code suffers from the clash of two opposing but desirable goals:

- Make minimal assumptions about the integrity of the hardware, and attempt to check each subsystem before using it (think of climbing a ladder and trying to check each rung before putting weight on it);
- Minimize the amount of tricky assembler code. Bootstrap sequences are almost never performance-sensitive, so an early change to a high-level language is desirable. But high-level language code tends to require more subsystems to be operational.

After basic initialization (like setting up *SR* so that the CPU can at least perform loads and stores) the major question is how soon read/write memory is available to the program, which is essential for calling functions written in C.

Software has an option here. R30xx family CPUs all have data cache on chip, and it is reasonable to regard on-chip resources as the lowest rungs on the ladder. The data cache can provide enough storage for C functions during bootstrap; memory might be read or written, but provided software uses less than a cache-size chunk of memory space it will never need to read memory data back from main memory.

## Starting up an application

To be able to start a C application the system needs:

- *Stack space*: assign a large enough piece of writable memory and initialize the *sp* register to its upper limit (aligned to an 8-byte boundary). Working out how large the stack should be can be difficult, so a large guess helps.
- Many systems implement a strategy of determining the amount of system RAM available, and assigning the start of the stack to the top of physical RAM. This is the technique used by IDT/sim. With such a strategy, the stack can have as much RAM as is available in the system, after the program.
- *Initialized data*: normally the C data area is initialized by the program loader to set up any variables which have been allocated values. Some compilation systems permit read-only data (implicit strings and data items declared *const*) to be managed in a separate “segment” of object code and put into ROM memory.

Initialized writable data can be used only if the compilation system and run-time system co-operate to arrange to copy writable data initialization from ROM into RAM. IDT/sim provides code which does this for the IDT/c and MIPS compilers.

- *Zeroed data (bss)*: in C all *static* and *extern* data items which are not explicitly initialized will be set up with a zero value. The compilation system may provide a routine for use at run time which zeroes the data segments.
- *global pointer initialization*: some compilation systems use the *gp* register for more efficient access to global variables. If the system software is compiled with this option, the OS must set the register to the right value.
- *Extra effort needed*: routines which may cause non-fatal exceptions require more run-time support. In particular, software should be aware that the architecture permits the FPA to abort an instruction with the “illegal opcode” trap when confronted with legal (but unusual) operand values (see the chapter on FPA architecture, later in this manual). Many ordinary arithmetic operations will produce an exception if they overflow.

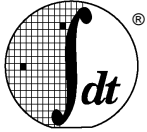

Integrated Device Technology, Inc.

## FLOATING POINT CO-PROCESSOR

## CHAPTER 8

In 1987 the MIPS FPA set a new benchmark for performance for microprocessor math performance. The FPA was a leading-edge silicon design bristling with innovation and ingenuity.

In the R30xx family, the R3081 contains this same FPA device, providing a combination of large caches, and high-performance integer and floating-point computation. This chapter describes the architecture of the FPA on-board the R3081 CPU.

### THE IEEE754 STANDARD AND ITS BACKGROUND

Floating point deals with the approximate representations of numbers (in the same way as decimals do); early computer implementations differed in the details of their behavior with very small or large numbers. This meant that numerical routines, identically coded, might behave differently. In some sense these differences shouldn't have mattered; systems would only produce different answers in circumstances where no implementation could really produce a "correct" answer.

Numerical routines are hard to prove correct. Small differences in values could accumulate and could mean, for example, that a routine relying on repeated approximation might converge to the correct result on one CPU, and fail to do so on another.

The IEEE754 standard (in full "ANSI/IEEE Std 754-1985 IEEE Standard for Binary Floating-Point Arithmetic") was introduced to bring order to this situation. The standard defines exactly what result will be produced by a small class of basic operations, even under extreme situations, ensuring that programmers can obtain identical results from identical inputs regardless of the machine used. IEEE754 has perhaps too many options, but is a huge improvement on the chaos which motivated it; since it became a real international standard in 1985, it has become the basis for all new implementations.

The operations regulated by IEEE754 include every operation which any MIPS R3000 FPA can do in hardware, plus some that must be emulated by software. IEEE754 legislates for:

- *Rounding and precision of results:* even results of the simplest operations may not be representable as finite fractions – in decimals

$$1/3 = 0.3333\dots$$

is infinitely recurring and can't be written precisely. IEEE754 allows the user to choose between four options: round up, round down, round towards zero and round to nearest. The rounded result will be that which would have been achieved by computing with infinite precision and then rounding. This would leave an ambiguity in "round to nearest" when the infinite-precision result is exactly half-way between two representable forms; the rules provide that in this case, rounding towards zero is proper.

- *When is a result exceptional?:* IEEE754 has its own meaning for the word "exception". A computation can produce a result which is:
  - a) nonsense, such as the square root of -1 ("invalid");
  - b) "division by zero" is given special treatment;
  - c) too big to represent ("overflow");
  - d) so small that its representation becomes problematic and precision is lost ("underflow");
  - e) not perfectly represented, like 1/3 ("inexact"). This is usually ignored.



All these are bundled together and described as “exceptional”.

- *Action taken on IEEE exception:* for each exception class listed above the user can opt:

- To ignore the problem, in which case the standard lays down what value will be produced. Overflows and division by zero generate “infinity” (with a positive and negative type); invalid operations generate “NaN” (for Not a Number) in two flavors called “Quiet” and “Signalling”.

The standard defines the results when operations are carried out on exceptional values (most often a NaN). A Quiet Nan as operand will not cause another exception (though the result will be a NaN too). A Signalling NaN causes an exception whenever it is used.

- To have the computation interrupted, and the user program signalled in some OS- and language-dependent manner.

Most programs leave all the IEEE exceptions off, but do rely on the system producing the right exceptional values.

## WHAT IS FLOATING POINT?

This section describes the various components of the data (always using the same bit-arrangement as does the MIPS implementation) and what they mean. Many readers will feel familiar with these concepts already; however, this section can still prove useful in providing insight to the R3081 treatment of these concepts.

Scientists wanting to write numbers which may be very large or very small are used to using exponential notation; so the distance from Earth to the Sun is:

$$93 \times 10^6 \text{ miles}$$

The number is defined by “93”, the *mantissa*†, and “6”, the *exponent*. Of course the same distance can be written:

$$9.3 \times 10^7 \text{ miles}$$

Numerical analysts like to use the second form; a decimal exponential with a mantissa between 1.0 and 9.999... is called *normalized*. The normalized form is useful for computer representation, since it doesn't require separate information about the position of the decimal point.

Floating point numbers are an exponential form, but base 2, not base 10. Not only are the mantissa and exponent held as binary fields, but the number is formed differently. The distance quoted above is:

$$1.3858079910278320312 \times 2^{26} \text{ miles}$$

The mantissa can be expressed as a binary “decimal”, which is just like a real decimal:

$$1.3858079910278320312 = 1 + 3 \times 1/10 + 8 \times 1/100 + 5 \times 1/1000 + \dots$$

is the same value as binary:

$$1.0110001011000101 = 1 + 0 \times 1/2 + 1 \times 1/4 + 1 \times 1/8 + \dots$$

However, neither the mantissa nor the exponent are stored just like this in IEEE formats.

---

† The mantissa may also be called “the fractional part” or “fraction”

### IEEE exponent field and bias

The exponent is not stored as a signed binary number, but *biased* so that the exponent field remains positive for the most negative legitimate exponent value; for the 64-bit IEEE format the exponent field is 11 bits long, so the bias is:

$$2^{10} - 1 = 1023$$

For a number

$$mantissa \times 2^{exp}$$

the exponent field will contain:

$$exponent + 1023$$

The biased exponent (together with careful ordering of the fields) has the rather useful effect of ensuring that FP comparisons (equality, greater than, less than, etc.) have the same result as would be obtained from comparing two signed integers composed of the same bits. FP compare operations can therefore be provided by cheap, fast and familiar logic.

Only exponents from 1 through 2046 represent ordinary numbers; the biggest and smallest exponent field values (all-zeroes and all ones) are reserved for special purposes, described later.

### IEEE mantissa and normalization

The IEEE format defines a single sign bit separate from the mantissa, (0 for positive, 1 for negative). So the stored mantissa only has to represent positive numbers. All properly-represented numbers in IEEE format are normalized, so

$$1 \leq mantissa < 2$$

This means that the most significant bit of the mantissa (the single binary digit before the point) is always a “1” – so it doesn’t actually need to be stored. The IEEE standard calls this the *hidden* bit.

So now the number 93,000,000, whose normalized representation has a binary mantissa of 1.01100010110001000101 and a binary exponent of 26, is represented in IEEE 64-bit format by setting the fields:

$$mantissafield = 011000101100010001010\dots$$

$$exponentfield = 1049 = 10000011001$$

Looking at it the other way; a 64-bit IEEE number with an exponent field of  $E$  and a mantissa field of  $m$  represents the number  $num$  where:

$$num = 1.m \times 2^{E-1023}$$

(“1.m” represents the binary fraction with 1 before the point and the mantissa field contents after it).

### Strange values use reserved exponent values

The smallest and biggest exponent field values are used to represent otherwise-illegal quantities:

- $E == 0$ : used to represent zero (with a zero mantissa) and “denormalized” forms, where the number is too small. The denormalized number with  $E$  zero and mantissa  $m$  represents  $num$  where:

$$num = 0.m \times 2^{-1022}$$

No R3000 series MIPS FPA is able to cope with either generating or computing with denormalized numbers, and operations creating or involving them will be punted to the software exception handler. The R4600 can be configured to replace denormalized results by zero and keep going.

- $E == 111...1$ : (i.e. the binary representation of 2047 in the 11-bit field used for an IEEE double) is used to represent:
  - a) with the mantissa zero, the “illegal” values  $+\text{inf}$ ,  $-\text{inf}$  (distinguished by the usual sign bit);
  - b) with the mantissa non-zero, it is a NaN. For MIPS, the most significant bit of the mantissa determines whether the NaN is quiet (ms bit zero) or signalling (ms bit one).

## MIPS FP Data formats

The MIPS architecture uses two FP formats recommended by IEEE754:

- *Single precision*: fitted into 32 bits of storage. Compilers for MIPS use single precision for *float* variables.
- *Double precision*: uses 64 bits of storage. C compilers use double precision for C *double* types.

The memory and register layout is shown in Table 8.1, “Floating point data formats”, with some examples of how the data works out. Note that the *float* representation can’t hold a number as big as 93,000,000 exactly.

	31	30	23	22	0
<b>single</b>	sign		exponent		mantissa
93000000	0	0001 1010		101 1000 1011 0001 0001	
0	0	0000 0000		000 0000 0000 0000 0000	
+infinity	0	1111 1111		000 0000 0000 0000 0000	
-infinity	1	1111 1111		000 0000 0000 0000 0000	
Quiet NaN	x	1111 1111		0xx xxxx xxxx xxxx xxxx	
Signalling NaN	x	1111 1111		1xx xxxx xxxx xxxx xxxx	
	high-order word			low-order word	
	31	30	20	19	0
<b>double</b>	sign		exponent		mantissa
93000000	0	000 0001 1010		1011 0001 0110 0010 0010 1000 0000 ....	
0	0	000 0000 0000		0000 0000 0000 0000 0000 0000 ....	
+infinity	0	111 1111 1111		0000 0000 0000 0000 0000 0000 ....	
-infinity	1	111 1111 1111		0000 0000 0000 0000 0000 0000 ....	
Quiet NaN	x	111 1111 1111		0xxx xxxx xxxx xxxx xxxx xxxx ....	
Signalling Nan	x	111 1111 1111		1xxx xxxx xxxx xxxx xxxx ....	

**Table 8.1. Floating point data formats**

The way that the two words making up a double are ordered in memory depends on the CPU configuration; for “big-endian” configuration the high-order word is at the lowest, 8-byte aligned location; for little endian the low-order word is at the lower location.

The following C structure types define the fields of the two FP types for a MIPS CPU.

```
#if BYTE_ORDER == BIG_ENDIAN
```

```

struct ieee754dp_konst {
    unsigned    sign:1;
    unsigned    bexp:11;
    unsigned    manthi:20; /* cannot get 52 bits into... */
    unsigned    mantlo:32; /* .. a regular C bitfield */
};

struct ieee754sp_konst {
    unsigned    sign:1;
    unsigned    bexp:8;
    unsigned    mant:23;
};

#else /* little-endian */

struct ieee754dp_konst {
    unsigned    mantlo:32;
    unsigned    manthi:20;
    unsigned    exp:11;
    unsigned    sign:1;
};

struct ieee754sp_konst {
    unsigned    mant:23;
    unsigned    bexp:8;
    unsigned    sign:1;
};

#endif

```

## MIPS IMPLEMENTATION OF IEEE754

IEEE754 is quite demanding, and sets two major problems:

- *Reporting exceptions makes pipelining harder*: If the user opts to be told when an IEEE exception happens, then to be useful this should happen synchronously<sup>†</sup>; after the trap, the user will want to see all previous instructions complete, all FP registers still in the pre-instruction state, and will want to be sure that no subsequent instruction has had any effect.

In the MIPS architecture hardware traps (as noted in an earlier chapter) are always like this. This does limit the opportunities for pipelining FP operations, because the CPU cannot commit the following instruction until the hardware can be sure that the FP operation will not produce a trap. To avoid adding to the execution time, an FP operation must decide to trap or not in the first clock phase after the operands are fetched. This is possible for most kinds of exceptional result; but if the FPA is configured to trap on the IEEE “inexact” exception all FP pipelining is inhibited, and everything slows down.

- *Denormalized numbers*: The representation of very small (“denormalized”) numbers and the exceptional values is too awkward for the FPA hardware to attempt, and they are instead passed on to the exception handler.

Note that *the MIPS architecture does not prescribe exactly what calculations will be performed without software intervention*. A complete software floating point emulator may be required for some systems.

---

<sup>†</sup> Elsewhere in this manual and the MIPS documentation this will be referred to as a “precise exception”. But since both “precise” and “exception” are used to mean different things by the IEEE standard, this chapter will describe them as a “synchronous trap”.

In practice, the FPA traps only on a very small proportion of the calculations which a program is likely to produce. Most systems are quite unlikely ever to produce anything that the hardware can't handle.

Existing R30xx family FPAs take the unimplemented trap whenever an operation should produce any IEEE exception or exceptional result other than “inexact” and “overflow”. For overflow, the hardware will generate an infinity or a largest-possible value (depending on the current rounding mode). The FPA hardware will not accept or produce denormalized numbers or NaNs.

## FLOATING POINT REGISTERS

The MIPS architecture defines 16 FP registers, usually given even numbers \$f0 - \$f30. There are also a set of 16 odd-numbered registers, each of which can take care of high-order bits of a 64-bit *double* value stored in the preceding even-numbered register†. The odd-numbered registers can be accessed by move and load/store instructions; but the assembler provides synthetic “macro” instructions for move and load/store double, so the assembly programmer may never reference the odd-numbered registers when writing code.

## FLOATING POINT EXCEPTIONS/INTERRUPTS

Floating point “exceptions” (enabled IEEE traps, or the “unimplemented operation” trap) are reported with an interrupt. In the R3081, one of the CPU interrupts will be dedicated to the FPA; the interrupt bit used is programmed in the R3081 Configuration register, defined in chapter 3. The default is to use the fifth interrupt bit in the CPU *Cause* register, corresponding to hardware interrupt 3; however, the mapping is software-configurable, enabling a variety of priority schemes.

Provided the corresponding interrupt-enable bit in the CPU status register *SR* is set, a floating point exception will happen “immediately”; no FP or integer operation following the FP instruction which caused the exception will have had any effect. At this point *epc* will point to the correct place to restart the instruction. As described earlier, *epc* will either point to the offending instruction, or to a branch instruction immediately preceding it. If it is the branch instruction, the BD bit will be set in the CPU status register *SR*.

If software performs FP operations with the FPA's interrupt disabled the system cannot guarantee IEEE754 compliance; even with all the IEEE traps disabled, the hardware will still attempt to trap on some conditions and will not produce IEEE754-approved results.

## THE FLOATING POINT CONTROL/STATUS REGISTER

The floating point control/status register (shown below) is coprocessor 1 control register 31 (mnemonic FCR31) and is accessed by *mtc1*, *mfc1* instructions.

31	24	23	22	18	17	16	12	11	7	6	2	1	0
0	C	0	UnImp	Cause	Enables	Flags	RM						

**Figure 8.1. FPA control/status register fields**

Notes on Figure 8.1, “FPA control/status register fields”

Fields marked “0” will read, and must be written, as zero.

- *C*: condition bit. This is set only by FP compare operations and tested by conditional branches.

† The role of the odd-numbered registers is not affected by the CPU's “endianness”.

- *RM*: rounding mode, as required by IEEE754. The values are:

RM Value	Description
0	“RN” (round to nearest). Round a result to the nearest representable value; if the result is exactly half way between two representable values, round to zero.
1	“RZ” (round towards zero). Round a result to the closest representable value whose absolute value is less than or equal to the infinitely accurate result.
2	“RP” (round up, or towards +infinity). Round a result to the next representable value up.
3	“RN” (round down, or towards -infinity). Round a result to the next representable value down.

**Table 8.2. Rounding modes encoded in FP control/status register**

Most systems define “RN” as the default behavior.

- *UnImp*: following an FPA trap, this bit will be set to mark an “unimplemented instruction” exception†.

This bit will be set and an interrupt raised whenever:

- there really is no instruction like this which the FPA will perform (but it is a “coprocessor 1” encoding); OR
- the FPA is not confident that it can produce IEEE754-correct result and/or exception signalling on this operation, with these operands.

For whatever reason, when “UnImp” is set the offending instruction should be re-executed by a software emulator.

If FP operations are run without the interrupt enabled, then any FPA operation which wants to take an exception will leave the destination register unaffected and the FP “Cause” bits undefined.

- *Cause/Enables/Flags*: Each of these is a 5-bit field, one bit for each IEEE exception type:

- Bit4 invalid operation.
- Bit3 division by zero.
- Bit2 overflow.
- Bit1 underflow.
- Bit0 inexact.

The three different fields work like this:

**Cause** bits are set (by hardware or emulation software) if and only if the last FP instruction executed resulted in that kind of exception.

**Flag** bits are “sticky” versions of the Cause bits, and are left set by any instruction encountering that exception. The Flag bits can only be zeroed again by writing *FPC31*.

**Enable** bits, when set, allow the corresponding “Cause” field bit to signal an interrupt.

The architecture promises that if the FPA doesn’t set the “UnImp” bit but does set a “Cause” bit, then both the “Cause” bit setting and the result produced (if the corresponding “Enable” bit is off) are in accordance with the IEEE754 standard.

The R3081 FPA will always rely on software emulation (i.e. uses the “unimplemented” trap) for some things:

---

† The MIPS documentation looks slightly different because it treats this as part of the “Cause” field.

- Any operation which is given a denormalized operand or “underflows” (produces a denormalized result) will trap to the emulator. The emulator itself must test whether the “Enable underflow” bit is set, and either cause an IEEE-compliant exception or produce the correct result.
- Operations which should produce the “invalid” trap are correctly identified; so if the trap is enabled the emulator must do nothing. But if the “invalid” bit is disabled the software emulator is invoked to generate the appropriate result (usually a Quiet NaN).  
Exactly the same is done with a Signalling NaN operand.
- FP hardware can handle overflow on arithmetic (producing either the extreme finite value or a signed infinity, depending on the rounding mode). But the software emulator is needed to implement a convert to integer operation which overflows.

The “Cause” bits are not reliable after an unimplemented exception.

A full emulator (capable of delivering IEEE-compatible arithmetic on a CPU with no FPA fitted) to back up the FPA hardware may prove necessary in certain applications.

FP Control instructions require care with the pipeline. See the appendix on pipeline hazards to see when the results are available to software.

## FLOATING POINT IMPLEMENTATION/REVISION REGISTER

This read-only register’s fields are shown in Figure 8.2, “FPA implementation/revision register”.

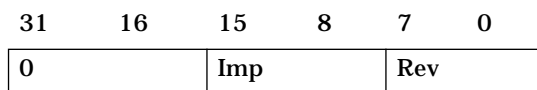

**Figure 8.2. FPA implementation/revision register**

This register is co-processor 1 control register 0 (mnemonic FCR0), and is accessed by *mtc1* and *mfc1* instructions.

Unlike the CPU’s field, the “Imp” field is useful. In the R30xx family it will contain one of two values:

- 0 No FPA is available. Reading this register is the recommended way of sensing the presence of an FPA. Note that software must enable “coprocessor 1” instructions before trying to read this register.
- 3 The FPA is compatible with that used for the R3000 CPU and its successors.

The “Rev” field contains no relevant software data.

## GUIDE TO FP INSTRUCTIONS

### Load/store

These operations load or store 32 bits of memory in or out of an FP register. General notes:

- The data is unconverted and uninspected, so no exception can occur even if the data does not represent a valid FP value.
- These operations can specify the odd-numbered FP registers.
- The load operation has a delay of one clock, and (like loading to an integer register) this is not interlocked. The compiler and/or assembler will usually take care of this; but it is invalid for an FP load to be immediately followed by an instruction using the loaded value.

- When writing in assembly, use the synthetic instructions. It is permissible to use any addressing mode which the assembler can understand (as described below).

Machine instructions (disp is signed 16-bit)

```
lwc1 fd, disp(rs)    fd <- *(rs + disp)
swc1 fs, disp(rs)    *(rs + disp) <- fs;
```

Synthesized by assembler

```
l.d fd, addr         fd = (double)*addr;
l.s fd, addr         fd = (float)*addr;
s.d fs, addr         (double)*addr = fs;
s.s fs, addr         (float)*addr = fs;
```

**Table 8.3. FP load/store instructions**

### Move between registers

No data conversion is done here (bit patterns are copied as-is) and no exception results from any value. These instructions can specify the odd-numbered FP registers.

<b>Between integer and FP registers</b>	
	<i>/* 32-bits uninterpreted */</i>
mtc1 rs, fd	fd = rs;
mfc1 rd, fs	rs = fd;
<b>Between FP registers</b>	
mov.d fd,fs	<i>/* move 64-bits between reg pairs */</i> fd = fs;
mov.s fd,fs	<i>/* 32-bits between registers */</i> fd = fs;

**Table 8.4. FP move instructions**

### 3-operand arithmetic operations

- All arithmetic operations can cause any IEEE exception type, and may result in an “unimplemented” trap if the hardware is not happy with the operands.
- All these instructions come in single-precision (32-bit, C float) and double-precision (64-bit, C double) format; the instructions are distinguished by a “.s” or “.d” on the opcode.



Software can't mix formats; both source values and the result will all be either single or double. To mix singles and doubles use explicit conversion operations.

add.d fd,fs1,fs2	fd = fs1 + fs2
add.s fd,fs1,fs2	
div.d fd,fs1,fs2	fd = fs1 / fs2
div.s fd,fs1,fs2	
mul.d fd,fs1,fs2	fd = fs1 x fs2
mul.s fd,fs1,fs2	
sub.d fd,fs1,fs2	fd = fs1 - fs2
sub.s fd,fs1,fs2	

**Table 8.5. FPA 3-operand arithmetic**

### Unary (sign-changing) operations

Although nominally arithmetic functions, these operations only change the sign bit and so can't produce most IEEE exceptions. They can produce an "invalid" trap if fed with a Signalling NaN value.

abs.d fd,fs	fd = abs(fs)
abs.s fd,fs	
neg.d fd,fs	fd = -fs
neg.s fd,fs	

**Table 8.6. FPA sign-changing operators**

### Conversion operations

Note that "convert from single to double" is written "cvt.d.s". All these use the current rounding mode, even when converting to and from integers. When converting data from CPU integer registers, the move from FP to CPU registers must be coded separately from the conversion operation.

Conversion operations can result in any IEEE exception.

cvt.d.s fd,fs	fd = (double) fs; /* float -> double */
cvt.d.w fd,fs	fd = (double) fs; /* int -> double */
cvt.s.d fd,fs	fd = (float) fs; /* double -> float */
cvt.s.w fd,fs	fd = (float) fs; /* int -> float */
cvt.w.s fd,fs	fd = (int) fs; /* float -> int */
cvt.w.s fd,fs	fd = (int) fs; /* double -> int */

**Table 8.7. FPA data conversion operations**

When converting from FP formats to 32-bit integer, the result produced depends on the current rounding mode.

### Conditional branch and test instructions

The FP test and branch instructions are separate. A test instruction compares two FP values and set the FPA condition bit accordingly (C in the FP status register); the branch instructions branch on whether the bit is set or unset.

The branch instructions are:

- `bc1f disp`     Branch if C bit ``false`` (zero)
- `bc1t disp`     Branch if C bit "true" (one)

Like the CPU's other conditional branch instructions *disp* is PC-relative, with a signed 16-bit field as a word displacement. *disp* is usually coded as the name of a label, which is unlikely to end up more than 128Kbytes away.

But before executing the branch, the condition bit must be set appropriately. The comparison operators are:

- `c.<cond>.d fs1,fs2`             Compare fs1 and fs2 and set C
- `c.<cond>.s fs1,fs2`

Where *<cond>* is any of 16 conditions called: *eq, f, le, lt, nge, ngl, ngle, ngt, ole, olt, seq, sf, ueq, ule, ult, un*. Why so many? These test for any "OR" combination of three mutually incompatible conditions:

- `fs1 < fs2`
- `fs1 == fs2`
- `unordered (fs1, fs2)`

The IEEE standard defines "unordered", and this relation is true for values such as infinities and NaN which do not compare meaningfully.

To test for conditions like "greater than" and "not equal", invert the test and then use a *bc1f* rather than a *bc1t* branch.

In addition to these combinations, each test comes in two flavors: one which takes an invalid trap if the operands are unordered, and one which never takes such a trap.

C bit is set if...	Mnemonic	
	trap	no trap
always false	f	sf
unordered(fs1,fs2)	un	ngl
fs1 == fs2	eq	seq
fs1 == fs2          unordered(fs1,fs2)	ueq	ngl
fs1 < fs2	olt	lt
fs1 < fs2          unordered(fs1,fs2)	ult	nge
fs1 < fs2          fs1 == fs2	ole	le
fs1 < fs2          fs1 == fs2          unordered(fs1,fs2)	ule	ngt

**Table 8.8. FP test instructions**

The compare instruction produces its result too late for the branch instruction to be the immediately following instruction; a delay slot is required.

For example:

```

if (f0 <= f2) goto foo;/* and don't branch if unordered */

    c.le.d  $f0, $f2
    nop                                # the assembler will do this
    bc1t   foo

if (f0 > f2) goto foo;/* and trap if unordered */
    
```

```

c.ole.d $f0, $f2
nop                # the assembler will do this...
bc1f    foo

```

Fortunately, many assemblers recognize and manage this delay slot properly.

## INSTRUCTION TIMING REQUIREMENTS

FP arithmetic instructions are interlocked (the instruction flow “stalls” automatically until results are available; the programmer does not need to be explicitly aware of execution times), and there is no need to interpose “nops” or to reorganize code for correctness. However, optimal performance will be achieved by code which lays out FP instructions to make the best use of overlapped execution of integer instructions, and the FP pipeline.

However, the compiler, assembler or (in the end) the programmer must take care about the timing of:

- *Operations on the FP control and status register:* moves between FP and integer registers complete late, and the resulting value cannot be used in the following instruction.
- *FP register loads:* like integer loads, take effect late. The value can't be used in the following instruction.
- *Test condition and branch:* the test of the FP condition bit using the **bc1t**, **bc1f** instructions must be carefully coded, because the condition bit is tested a clock earlier than might be expected. So the conditional branch cannot immediately follow a test instruction.

## INSTRUCTION TIMING FOR SPEED

The R30xx family FPA takes more than one clock for most arithmetic instructions, and so the pipelining becomes visible. The pipeline can show up in three ways:

- *Hazards:* where the software must ensure the separation of instructions to work correctly;
- *Interlocks:* where the hardware will protect the software by delaying use of an operand until it is ready, but knowledgeable re-arrangement of the code will improve performance;
- *Overlapping:* where the hardware is prepared to start one operation before another has completed, provided there are no data dependencies. This is discussed later.

Hazards and interlocks arise when instructions fail to stick to the general MIPS rule of taking exactly one clock period between needing operands and making results ready. Some instructions either need operands earlier (branches, particularly, do this), or produce results late (e.g. loads). All R30xx family instructions which can cause trouble are tabulated in an appendix of this manual.

## INITIALIZATION AND ENABLE ON DEMAND

Reset processing will normally initialize the CPU's *SR* register to disable all optional co-processors, which includes the FPA (alias coprocessor 1). The *SR* bit CU1 has to be set for the FPA to work.

To determine availability of a hardware FPA, software should read the FPA implementation register; if it reads zero, no FP is fitted and software should run the system with CU1 off†. Once CU1 is enabled, software should setup the control/status register *FCR31* with the system choice of rounding modes and trap enables.

Once the FPA is operating, the FP registers should be saved and restored during interrupts and context switches. Since this is (relatively) time-consuming, software can optimize this:

- Leave the FPA disabled by default when running a new task. Since the task cannot now access the FPA, the OS doesn't have to save and restore registers.
- On a FP instruction trap, mark the task as an FP user and enable the FP before returning to it.
- Disable FP operations while in the kernel, or in any software called directly or indirectly from an interrupt routine. This avoids saving FP registers on an interrupt; instead FP registers need be saved only when context-switching to or from an FP using task.

## FLOATING POINT EMULATION

The low-cost members of the R30xx family do not have a hardware FPA. Floating point functions for these processors are provided by software, and are slower than the hardware. Software FP is useful for systems where floating point is employed in some rarely-used routines.

There are two approaches:

- *Soft-float*: Some compilers can be requested to implement floating point operations with software. In such a system, the instruction stream does not contain actual floating point operations; instead, when the software requests floating point from the compiler, the compiler inserts a call to a dedicated floating point library. This eliminates the overhead of emulating a floating point register file, and also the overhead of decoding the requested operation.
- *Run-time emulation*: The compiler can produce the regular FP instruction set. The CPU will then take a trap on each FP instruction, which is caught by the FP emulator. The emulator decodes the instruction and performs the requested operation in software.

Part of the emulator's job will be emulating the FP register set in memory.

This technique is much slower than the soft-float technique; however, the binaries generated will automatically gain significant performance when executed by an R3081, simplifying system upgrades.

As described above, a run-time emulator may also be required to back up FP hardware for very small operands or obscure operations; and, for maximal flexibility that emulator is usually complete. However, it will be written to ensure exact IEEE compatibility and is only expected to be called occasionally, so it will probably be coded for correctness rather than speed.

Compiled-in floating point (soft-float) is much more efficient on integer only chips; the emulator has a high overhead on each instruction from the trap handler, instruction decoder, and emulated register file.

---

† Some systems may still enable CP1, to use the BrCond(1) input pin as an input port. The software must then insure that no FPA operations are actually required, since the CPU will presume that they are actually executed.

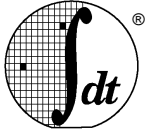

Integrated Device Technology, Inc.

## ASSEMBLER LANGUAGE PROGRAMMING

## CHAPTER 9

This chapter details the techniques and conventions associated with writing and reading MIPS assembler code. This is different from just looking at the list of machine instructions because:

- 1) MIPS assemblers provide a large number of extra “macro” instructions which provide a richer instruction set than in fact exists at the machine level.
- 2) Programmers need to know the exact syntax of directives to start and end functions, define data, control instruction ordering and optimization, etc.

Before reading much further, it may be a good idea to go back and review Chapter 2 (MIPS Architecture). It describes the low-level machine instruction set, data types, addressing modes, and conventional register usage.

### SYNTAX OVERVIEW

Appendix C of this manual contains the formal syntax for the original MIPS Corp. assembler; most assemblers from other vendors follow this closely, although they may differ in their support of certain directives. These directives and conventions are similar to those found in other assemblers, especially a UNIX† assembler.

### Key points to note

- The assembler allows more than one statement on each line, as long as they are separated by semi-colons.
- "White space" (tabs and spaces) is permitted between any symbols.
- All text from a '#' to the end of the line is a comment and is ignored, but do not put a '#' in column 1.
- Identifiers for labels, variables, etc. can be any combination of alpha-numeric characters plus '\$', '\_' and '.', except for the first character which cannot be numeric:

#### *Good labels:*

```
AVeryLongIdentifier # lower case is different from upper case
frog$spawn          # dollars allowed in names
frog.spawn          # '.' is also valid
__peculiar2         # leading underscores often used to
                    # avoid name clashes in C
```

#### *Bad labels:*

```
7down               # leading decimal
frog-spawn          # "-" not allowed
```

- The assembler allows the use of numbers (decimal between 1-99) as a label. These are treated as “temporary”, and are “re-usable”. In a branch instruction “1f” (forward) refers to the next “1:” label in the code, and “1b” (back) refers to the last-met “1:” label.

This eliminates the need for inventing unique but meaningless names for little branches and loops. Many programmers reserve named labels for subroutine entry points.

---

† UNIX is a trademark of Univel Inc.

- The MIPS Corp. assembler, among others, provides the conventional register names (*a0*, *t5*, etc.) as C pre-processor macros; thus, the programmer must pass the source through the C preprocessor and include the file `<regdef.h>`<sup>†</sup>.
- If the C preprocessor is indeed used, then typically it is permitted to also use C-style `/*` comments `*/` and macros.
- Hexadecimal constants are numbers preceded by “0x” or “0X”; octal constants must be preceded by “0”; be careful not to put a redundant zero on the front of a decimal constant. Constants are:

```

0           # strictly octal zero, but who cares?
0x80000000 # the biggest negative integer
0377       # 255 decimal, probably what was meant
08         # illegal (0 implies octal)
01024      # octal for 528, probably not what was meant

```

- **Pointer values** can be used; in a word context, a label or relocatable symbol stands for its address as a 32-bit integer. The identifier `.` (dot) represents the current location counter.

Many assemblers even allow some limited arithmetic.

- **Character constants and strings** can contain the following special characters, introduced by the backslash `\` escape character:

character	generated code
<code>\a</code>	alert (bell)
<code>\b</code>	backspace
<code>\e</code>	escape
<code>\f</code>	formfeed
<code>\n</code>	newline
<code>\r</code>	carriage return
<code>\t</code>	horizontal tab
<code>\v</code>	vertical tab
<code>\\</code>	backslash
<code>\'</code>	single quote
<code>\"</code>	double quote
<code>\0</code>	null (integer 0)

A character can be represented as a one-, two-, or three-digit octal number (`\` followed by octal digits), or as a one-, two-, or three-digit hexadecimal number (`\x` followed by hexadecimal digits).

- The precedence of binary and unary operations in constant expressions follows the C definition.

## REGISTER-TO-REGISTER INSTRUCTIONS

Most MIPS machine instructions are three-register operations, i.e. they are arithmetic or logical functions with two inputs and one output, for example:

---

<sup>†</sup> In IDT/c version 5.0 and later, the header files exist in the directory `/idtc`. The pre-processor is automatically invoked if the extension of the filename is anything other than `.s`. To force the pre-processor to be used with `.s` files, use the switch `-xassemble-with-cpp` in the command line.

$rd = rs + rt$

- *rd*: is the *destination* register, which receives the result of functions *op*;
- *rs*: is a *source* register (operand);
- *rt*: is a second *source* register.

In MIPS assembly language these type of instructions are written:  
 opcode rd, rs, rt

For example :

addu \$2, \$4, \$5 # \$2 = \$4 + \$5

Of course any or all of the register operands may be identical. To produce a CISC-style, two-operand instruction just use the destination register as a source operands; the assembler will do this automatically if *rs* is omitted.

addu \$4, \$5 → addu \$4, \$4, \$5 # \$4 = \$4 + \$5

Unary operations (e.g. **neg**, **not**) are always synthesized from one or more of the three-register instructions. The assembler expects maximum of two operands for these instructions (*dst* and *src*):

neg \$2, \$4 → sub \$2, \$0, \$4 # \$2 = -\$4  
 not \$3 → nor \$3, \$0, \$3 # \$3 = ~\$3

Probably the most common register-to-register operation is **move**. This ubiquitous instruction is in fact implemented by an **addu** with the always zero-valued register *\$0*:

move \$3, \$5 → addu \$3, \$5, \$0 # \$3 = \$5

## IMMEDIATE (CONSTANT) OPERANDS

An immediate operand is the traditional term for a constant value found in a field of the instruction. Many of the MIPS arithmetic and logical operations have an alternative form which use a 16-bit immediate in place of *rt*. The immediate value is first sign-extended or zero-extended to 32-bits, for arithmetic or logical operations respectively.

Although an immediate operand implies different low-level machine instruction from its three-register version (e.g. **addi** instead of **add**), there is no need for the programmer to write this explicitly. The assembler will spot the case when the final operand is an immediate, and use the correct machine instruction. For example:

add \$2, \$4, 64 → addi \$2, \$4, 64

If an immediate value is too large to fit into the 16-bit field in the machine instruction, then the assembler helps out again. It automatically loads the constant into the *assembler temporary register \$at/\$1* and then performs the operation using that.

add \$4, 0x12345 → li \$at, 0x12345  
 add \$4, \$4, \$at

Note the **li** (*load immediate*) instruction, which again isn't found in the machine's instruction set; **li** is a heavily-used macro instruction which loads a 32-bit integer value into a register, without the programmer having to worry about how it gets there:

- When the 32-bit value lies between  $\pm 32K$  it can use a single **addiu** with **\$0**; when bits 31-16 are all zero it can use **ori**; when the bits 15-0 are all zero it will be **lui**; and when none of these is possible it will be a an **lui/ori** pair:

```

li    $3, -5      →    addiu $3, $0, -5
li    $4, 0x8000  →    ori   $4, $0, 0x8000
li    $5, 0x120000→lui   $5, 0x12
li    $6, 0x12345→lui   $6, 0x1
                                ori   $6, $6, 0x2345

```

## MULTIPLY/DIVIDE

The multiply and divide machine instructions are unusual:

- they do not accept immediate operands;
- they do not perform overflow or divide-by-zero tests;
- they operate asynchronously – so other instructions can be executed while they do their work;
- they store their results in two separate result registers (*hi* and *lo*), which can only be read with the two special instructions **mghi** and **mflo**;
- the result registers are interlocked – they can be read at any time after the operation is started, and the processor will stall until the result is ready.

However the conventional assembler multiply/divide instructions will hide this: they are complex macro instructions which simulate a three-operand instruction and perform overflow checking. A signed divide may generate about 13 instructions, but they execute in parallel with the hardware divider so that no time is wasted (the divide itself takes 35 cycles).

Instruction	Description
mul	simple unsigned multiply, no checking
mulo	signed multiply, checks for overflow above 32-bits
mulou	unsigned multiply, checks for overflow above 32-bits
div	signed divide, checks for zero divisor or divisor of -1 with most negative dividend.
divu	unsigned divide, checks for zero divisor
rem	signed remainder, checks for zero divisor or divisor of -1 with most negative dividend.
remu	unsigned remainder, checks for zero divisor

Some MIPS assemblers will convert constant multiplication, and division/remainder by constant powers of two, into the appropriate shifts, masks, etc. Don't rely on this though, as most toolchains expect the compiler or assembly-language programmer to spot this sort of optimization.

To explicitly control the multiplication, specify a *dst* of *\$0*. The assembler will issue the raw machine instruction to start the operation; it is then up to the programmer to fetch the result from *hi* and/or *lo* and, if required, perform overflow checking.



## LOAD/STORE INSTRUCTIONS

The following table lists all the assembler's load/store instructions. The signed load instructions sign-extend the memory data to 32-bits; the unsigned instructions zero-extend.

Load		Store	Description
Signed	Unsigned		
lw		sw	word
lh	lhu	sh	halfword
lb	lbu	sb	byte
ulw		usw	unaligned word
ulh	ulhu	ush	unaligned halfword
lwl		swl	word left
lwr		swr	word right
l.d		s.d	double precision floating-point
l.s		s.s	single precision floating-point (i.e., coprocessor 1 register)
lwc1		swc1	

Don't forget the architectural constraints of load/store instructions:

- *Strict alignment*: addresses must be aligned correctly (i.e. a multiple of 4 for words, and 2 for halfwords), except for the special *left*, *right* and *unaligned* variants (described below), or else they will cause an exception.
- *Load delay*: all load instructions require at least one other instruction between them and the instruction which uses their result – but most assemblers should guarantee this by inserting a **nop** if necessary. There is a special exception to this rule for **lwl** followed immediately by **lwr** to the same register, or *vice versa* (the last instruction of the pair will still have the delay slot, but no delay slot is required between the instructions in the pair).

### Unaligned loads and store

As noted above, normal load and store instructions must have a correctly aligned address. This can occasionally cause problems when porting software from CISC architectures which allow unaligned addresses.

All data structures that are declared as part of a standard C program will be aligned correctly. But addresses computed at run-time, or data structures declared using a non-standard language extension, may require that software copes with unaligned addresses. While this can be done by a combination of byte loads, shifts and adds, the MIPS architecture provides the special purpose **lwl**, **lwr**, **swl** and **swr** instructions. An unaligned word can be accessed using just two of these special instructions as a pair, however they are not usually used directly, but are generated by the **ulw** (unaligned load word) and **usw** (unaligned store word) macro instructions.

The **ulh**, **ulhu**, and **ush** unaligned halfword macro instructions do not use the special instructions. Unaligned halfwords loads generate two **lb**'s, a **shl** and an **or** (4 instructions); stores generate two **sb**'s and a **shr** (3 instructions).

## ADDRESSING MODES

As discussed above, the hardware supports only one addressing mode:  $base\_reg+offset$ , where  $offset$  is in the range  $-32768$  to  $32767$ . However the assembler simulates *direct* and *direct-index-reg* addressing modes by using two or three machine instructions, and the assembler-temporary register.

```

lw    $2, ($3)    →    lw    $2, 0($3)

lw    $2, 8+4($3) →    lw    $2, 12($3)

lw    $2, addr    →    lui    $at, %hi_addr
                    lw    $2, %lo_addr($at)

sw    $2, addr($3) →    lui    $at, %hi_addr
                    addu   $at, $at, $3
                    sw    $2, %lo_addr($at)

```

The store instruction is written with the source register first and the address second, to look like a load; for other operations the destination is first.

The symbol *addr* in the above examples can be any of these things:

- a *relocatable symbol* – the name of a label or variable (whether in this module or elsewhere);
- a relocatable symbol  $\pm$  a constant expression;
- a 32-bit constant expression (e.g. the absolute address of a device register).

The constructs “%hi\_” and “%lo\_” do not actually exist in the assembler, but represent the high and low 16-bits of the address. This is not quite the straightforward division into low and high words that it looks, because the 16-bit offset field of a **lw** is treated as signed. So if the “addr” value is such that bit 15 is a “1”, then the %lo\_addr value will act as negative, and the assembler needs to increment %hi\_addr to compensate:

addr	%hi_addr	%lo_addr
0x12345678	0x1234	0x5678
0x10008000	0x1001	0x8000

The **la** (*load address*) macro instruction provides a similar service for addresses as the **li** instruction provides for integer constants:

```

la    $2, 4($3)    →    addiu  $2, $3, 4

la    $2, addr    →    lui    $at, %hi_addr
                    addiu  $2, $at, %lo_addr

la    $2, addr($3) →    lui    $at, %hi_addr
                    addiu  $2, $at, %lo_addr
                    addu   $2, $2, $3

```

In principle, **la** could avoid apparently-negative “%lo\_” values by using an **ori** instruction. But the linker has to be able to fix up addresses in the signed “%lo\_” format found for load/store instructions – so **la** uses the add instruction so as to use the same kind of address fixup.

## Gp-relative addressing

Loads and stores to global variables or constants usually require at least two instructions, e.g.:

```

lw    $2, addr    →    lui    $at, %hi_addr
                    lw    $2, %lo_addr($at)

```

```

sw    $2, addr($3) →    lui    $at, %hi_addr
                                addu   $at, $at, $3
                                sw     $2, %lo_addr($at)

```

A common low-level optimization supported by many toolchains is to use *gp-relative addressing*. This technique requires the cooperation of the compiler, assembler, linker and run-time start-up code to pool all of the “small” variables and constants into a single region of maximum size 64Kb, and then set register \$28 (known as the *global pointer* or *gp* register) to point to the middle of this region†. With this knowledge the assembler can reduce the number of instructions used to access any of these small variables, e.g.:

```

lw    $2, addr    →    lw    $2, addr - _gp($at)
sw    $2, addr($3) →    addu   $at, $gp, $3
                                sw     $2, addr - _gp($at)

```

By default most toolchains consider objects less than or equal to 8 bytes in size to be “small”. This limit can usually be controlled by the ‘-G n’ compiler/assembler option; specifying ‘-G 0’ will switch this optimization off altogether.

While it is a useful optimization, there are some pitfalls to beware of:

- The programmer must take special care when writing assembler code to declare global data items correctly:

- a) Writable, initialized data of 8 bytes or less must be put explicitly into the `.sdata` section.
- b) Global *common* data must be declared with the correct size, e.g:

```

.comm  smallobj, 4
.comm  bigobj, 100

```

- c) Small external variables should also be explicitly declared, e.g:

```

.externsmalltext, 4

```

- d) Most assemblers are effectively one-pass, so make sure that the program declares data before using it in the code, to get the most out of the optimization.

- In C, global variables must be declared correctly in all modules which use them. For external arrays either omit the size (e.g. `extern int extarray[]`), or give the correct size (e.g. `int cmnarray[NARRAY]`). Don’t just give a dummy size of 1.
- A very large number of small data items or constants may cause the 64Kb limit to be exceeded, causing strange relocation errors when linking. The simplest solution here is to completely disable *gp*-relative addressing (i.e. use `-G 0`).
- Some real-time operating systems, and many PROM monitors, can be entered by direct subroutine calls, rather than via a single “system call” interface. This makes it impossible (or at least very difficult) to switch back and forth between the two different values of *gp* that will be used by the application, and by the o/s or monitor. In this case either the applications or the o/s (but not necessarily both) must be built with `-G 0`.
- When the `-G 0` option has been used for compilation of any set of modules, then it is usually essential that all libraries should also be compiled that way, to avoid relocation errors.

---

† The actual handling may be toolchain dependent; this is the most common technique.

## JUMPS, SUBROUTINE CALLS AND BRANCHES

The MIPS architecture follows Motorola nomenclature:

- PC-relative instructions are called “branch”, and absolute-addressed instructions “jump”; the operation mnemonics begin with a **b** or **j**.
- A subroutine call is “jump and link” or “branch and link”, and the mnemonics end **.al**.
- All the branch instructions, even branch-and-link, are conditional, testing one or two registers. They are therefore described in the next section. However, unconditional versions can be readily synthesized, e.g.: **beq \$0, \$0, label**.

Jump instructions are:

- **j**: this instruction (*jump*) transfers control unconditionally to an absolute address. Actually, **j** doesn’t quite manage a 32-bit address; the top 4 address bits of the target are not defined by the instruction and the top 4 bits of the current “PC” value is used instead.

Most of the time this doesn’t matter: 28-bits still gives a maximum code size of 256 Mb. It can be argued that it is useful in system software, because it avoids changing the top 3 address bits which select the address segment (described earlier in this manual).

To reach a really long way away, use the **jr** (*jump to register*) instruction; which is also used for computed jumps.

- **jal, jalr**: these instructions implement a direct and indirect subroutine call. As well as jumping to the specified address, they store the current  $pc + 8$  in register  $\$31$  (*ra*). Why add 8 to the program counter? Remember that jump instructions, like branches, always execute the following instruction (at  $pc + 4$ ), so the return address is the instruction *after* the branch delay slot. Subroutine return is normally done with **jr \$31**.

Position independent subroutine calls can use the **bal**, **bgezal** and **bltzal** instructions.

## CONDITIONAL BRANCHES

The MIPS architecture does not include a condition code register. Conditional branch machine instructions test one or two registers; and, together with a small group of compare-and-set instructions, are used to synthesize a complete set of arithmetic conditional branches.

Conditional branches are always PC-relative.

Branch instructions are listed below. Again there are architectural considerations:

- *Limited branch offset for PC-relative branches*: the maximum branch displacement is  $\pm 32768$  instructions ( $\pm 128K$  bytes), because a 16-bit field is used for the offset.
- *Branch delay slot*: the instruction immediately after a branch (or a jump) is always executed, whether or not the branch is taken. Many assemblers will normally hide this from the programmer, and will try to fill the branch delay slot with a useful instruction, or a **nop** if this is not possible.
- *No carry flag*: due to the lack of condition codes; if software need to check for carry, then compare the operands and results to work out when it occurs (typically, this requires only one **slt** instruction).
- *No overflow flag*: though the add and subtract instructions are available in an optional form which causes a trap if the result overflows into the sign bit. C compilers typically won’t generate those instructions, but Fortran might.

### Co-processor conditional branches

There are four pairs of branches, testing true/false on four “coprocessor condition” values CPCOND0-3. In the R3081, CPCOND1 is an internal flag which tests the floating point condition set by the FP compare instructions. Note that the coprocessor must be enabled for the branch instruction to be executed.

### COMPARE AND SET

The compare-and-set instructions conform to the C standard; they set their destination to 1 if the condition is true, and zero otherwise. Their mnemonics start with an “s”: so **seq rd, rs, rt** sets **rd** to a 1 or zero depending on whether **rs** is equal to **rt**. These instructions operate just like any 3-operand MIPS instruction.

Floating point comparisons are done quite differently, and are described in the Floating-Point Accelerator chapter.

### COPROCESSOR TRANSFERS

CPU control functions are provided by a set of registers, which the instruction set accesses as “co-processor 0” data registers. These registers deal with catching exceptions and interrupts, and accessing the memory management unit and caches. A R3051 family CPU has at least 12 registers; some have more. There’s much more about this in earlier chapters.

The floating point accelerator is “co-processor 1”, and is described in an earlier chapter. It has 16 64-bit registers to hold single- or double-precision FP values, which come apart into 32 32-bit registers when doing loads, stores and transfers to/from the integer registers. There are also two floating point control registers accessed with **ctc1**, **cfc1** instructions.

“Co-processor” instructions are encoded in a standard way, and the assembler doesn’t have to know much about what they do.

There are a range of instructions for moving data to and from the coprocessor data and control registers. The assembler expects numbers specified with “\$” in front (except for floating point registers, which are called \$f0 to \$f31); but most toolchains provide a header file for the C pre-processor which provides meaningful names for the CPU control and FP control registers.

The assembler syntax makes no special provisions for “co-processor” registers; so if the program contains “obvious” mistakes (like reversing the CPU and special register names) the assembler will just silently do the wrong thing.

Instruction	Description
mfc0 dst, dr	move from CPU control register (to integer register)
mtc0 src, dr	move to CPU control register (from integer register)
cfc1 dst, cr	move from fpa control register (to integer register)
ctc1 src, cr	move to fpa control register (from integer register)
mfc1 dst, dr	move from FP register to integer register
mtc1 src, dr	move to FP register from integer register
swc1 dr, offs(base)	store FP register (to memory)
lwc1 dr, offs(base)	load FP register (from memory)

Like conventional load instructions, there must always be one instruction after the move before the result can be used (the load-delay slot), whichever direction data is being moved.

## Coprocessor Hazards

A pipeline hazard occurs when the architecture definition allows the internal pipelining to “show through” and affect the software: examples being the load and branch delay slots. Most MIPS assemblers will usually shield the programmer from hazards by moving instructions around or inserting **NOP**'s, to ensure that the code executes as written.

However some CPU control register writes have side-effects which require pipeline-aware programming; since most assemblers don't understand anything about what these instructions are doing, they may not help.

One outstanding example is the use of interrupt control fields in the *Status* and *Cause* registers. In these cases the programmer must account for any side-effects, and the fact that they are delayed for up to three instructions. For example, after an **mtc0** to the *Status* register which changes an interrupt mask bit, it will be two further instructions before the interrupt is actually enabled or disabled. The same is also true when enabling or disabling floating-point coprocessor instructions (i.e. changing the CU1 bit).

To cope with these situations usually requires the programmer to take explicit action to prevent the assembler from scheduling inappropriate instructions after a dangerous **mtc0**. This is done by using the **.set noreorder** directive, discussed below.

A comprehensive summary of pipeline hazards can be found later in this chapter.

## ASSEMBLER DIRECTIVES

### Sections

The names of, and support for different code and data sections is likely to differ from one toolchain to another. Most will at least support the original MIPS conventions, which are illustrated (for ROMable programs) by Figure 9.1, “Program segments in memory”.

Within an assembler program the sections are selected as shown in Figure 9.1, “Program segments in memory”.

#### **.text, .rdata, .data**

Simply put the appropriate section name before the data or instructions, for example:

```

        .rdata
msg:    .asciiz"Hello world!\n"

        .data
table:  .word  1
        .word  2
        .word  3

        .text
func:   sub    sp, 64
        ...

```

#### **.lit4, .lit8**

These sections cannot be selected explicitly by the programmer. They are read-only data sections used implicitly by the assembler to hold floating-point constants which are given as arguments to the **li.s** or **li.d** macro instructions. Some assemblers and linkers will save space by combining identical constants.

	ROM	
		etext
	<b>.rdata</b>	
	<i>read-only data</i>	
	<b>.text</b>	
1fc0000	<i>program code</i>	_ftext
	RAM	
????????		
	<i>stack</i>	
	<i>grows down from top of memory</i>	
	<i>heap</i>	
	<i>grows up towards stack</i>	
		end
	<b>.bss</b>	
	<i>uninitialized writable data</i>	
	<b>.sbss</b>	
	<i>uninitialized writable small data</i>	_fbss
		edata
	<b>.lit8</b>	
	<i>64-bit floating point constants</i>	
	<b>.lit4</b>	
	<i>32-bit floating point constants</i>	
	<b>.sdata</b>	
	<i>writable small data</i>	
	<b>.data</b>	
00000200	<i>writable data</i>	_fdata
	<i>exception vectors</i>	
00000000		

Figure 9.1: Program segments in memory

**.bss**

This section is used to collect *uninitialized* data, the equivalent of C and Fortran's *common* data. An uninitialized object is declared, together with its size. The linker then allocates space for it in the **.bss** section, using the maximum size from all those modules which declare it. If any module declares it in a real, *initialized* data section, then all the sizes are ignored and that definition is used.

```
.comm dbgflag, 4    # global common variable, 4 bytes
.lcomm sum, 4      # local common variable, 8 bytes
.lcomm array, 100  # local common variable, 100 bytes
```

“Uninitialized” is actually a misnomer: although these sections occupy no space in the object file, the run-time start-up code or operating-system must clear the **.bss** area to zero before entering the program; most C programs will rely on this behavior. Many tool chains will accommodate this need through the start up file provided with the tool, to be linked with the user program<sup>†</sup>.

**.sdata, .sbss**

These sections are equivalent to the **.data** and **.bss** sections above, but are used in some toolchains to hold *small*<sup>‡</sup> data objects. This was described earlier in this chapter, when the use of the *gp* was discussed.

**Stack and heap**

The *stack* and *heap* are not real sections that are recognized by the assembler or linker. Typically they are initialized and maintained by the run-time system by setting the *sp* register to the top of physical memory (aligned to an 8-byte boundary), and setting the initial *heap* pointer (used by the *malloc* functions) to the address of the **end** symbol.

**Special symbols**

Figure 9.1, “Program segments in memory” also shows a number of special symbols which are automatically defined by the linker to allow programs to discover the start and end of their various sections. Some of these are part of the normal UNIX<sup>††</sup> environment expected by many programs; others are specific to the MIPS environment.

Symbol	Standard?	Value
_ftext		start of text (code) segment
etext	✓	end of text (code) segment
_fdata		start of initialized data segment
edata	✓	end of initialized data segment
_fbss		start of uninitialized data segment
end	✓	end of uninitialized data segment

**Data definition and alignment**

Having selected the correct section, the data objects themselves are specified using the directives described in this section.

<sup>†</sup> IDT/c provides this code in the file “/idtc/idt\_csu.S”.

<sup>‡</sup> The default for “small” is 8 bytes. This number can be changed with the “-G” compiler/assembler switch.

<sup>††</sup> UNIX is a trademark of Univel Inc.



**.byte, .half, .word**

These directives output integers which are 1, 2, or 4 bytes long, respectively. A list of values may be given, separated by commas. Each value may be repeated a number of times by following it with a colon and a repeat count. For example.

```
.byte 3           # 1 byte:3
.half 1, 2, 3     # 3 halfwords:1 2 3
.word 5 : 3, 6, 7 # 5 words:5 5 5 6 7
```

Note that the section's location counter is automatically aligned to the appropriate boundary before the data is emitted. To actually emit unaligned data, explicit action must be taken using the **.align** directive described below.

**.float, .double**

These output single or double precision floating-point values, respectively. Multiple values and repeat counts may be used in the same way as the integer directives.

```
.float 1.4142175 # 1 single-precision value
.double 1e+10, 3.1415 # 2 double-precision values
```

**.ascii, .asciiz**

These directives output ASCII strings, either without or with a terminating null character respectively. The following example outputs two identical strings:

```
.ascii "Hello\0"
.asciiz "Hello"
```

**.align**

This directive allows the programmer to specify an alignment greater than that which would normally be required for the next data directive. The alignment is specified as a power of two, for example:

```
.align 4 # align to 16-byte boundary (24)
var: .word 0
```

If a label (*var* in this case) comes immediately before the **.align**, then the label will still be aligned correctly. For example, the following is exactly equivalent to the above:

```
var: .align 4 # align to 16-byte boundary (24)
     .word 0
```

For “packed” data structures this directive allows the programmer to override the automatic alignment feature of **.half**, **.word**, etc., by specifying a zero alignment. This will stay in effect until the next section change. For example:

```
.half 3 # correctly aligned halfword
.align 0 # switch off auto-alignment
.word 100 # word aligned on halfword boundary
```

**.comm, .lcomm**

These directives declare a *common*, or *uninitialized* data object by specifying the object's name and size.

An object declared with **.comm** is shared between all modules which declare it: it is allocated space by the linker, which uses the largest declared size. If any module declares it in one of the initialized **.data**, **.sdata** or **.rdata** sections, then all the sizes are ignored and the initialized definition is used instead<sup>†</sup>.

An object declared with **.lcomm** is local to the current module, and is allocated space in the “uninitialized” **.bss** (or **.sbss**) section by the assembler.

```
.comm dbgflag, 4    # global common variable, 4 bytes
.lcomm array, 100  # local uninitialized object, 100 bytes
```

### **.space**

The **.space** directive increments the current section’s location counter by a number of bytes, for example:

```
struc: .word 3
      .space 120    # 120 byte gap
      .word -1
```

For normal data and text sections it just emits that many zero bytes, but in assemblers which allow the programmer to declare new sections with labels but no real content (like **.bss**), it will just increment the location counter without emitting any data.

## **Symbol binding attributes**

Symbols (i.e. labels in one of the code or data segments) can be made visible and used by the linker which joins separate modules into a single program. The linker *binds* a symbol to an address and substitutes the address for assembler-language references to the symbol.

Symbols can have three levels of visibility:

- *Local*: invisible outside the module they are declared in, and unused by the linker. The programmer does not need to worry about whether the same local symbol name is used in another module.
- *Global*: made public for use by the linker. Programs can refer to a global symbol in another module without defining any local space for it, using the **.extern** directive.
- *Weak global*: obscure feature provided by some toolchains. This allows the programmer to arrange that a symbol nominally referring to a locally-defined space will actually refer to a global symbol, if the linker finds one. If the linked program has no global symbol with that name, the local version is used instead.

The preferred programming practice is to use the **.comm** directive whenever possible.

### **.globl**

Unlike C, where module-level data and functions are automatically *global* unless declared with the `static` keyword, all assembler labels have *local* binding unless explicitly modified by the **.globl** directive.

To define a label as having *global* binding that is visible to other modules, use the directive as follows:

```
.data
.globl status          # global variable
status: .word 0

.text
.globl set_status# global function
```

<sup>†</sup> The actual handling may be toolchain dependent; this is the most common technique.

```

set_status:
    subu    sp,24
    ...

```

Note that **.globl** is not required for objects declared with the **.comm** directive; these automatically have global binding.

### **.extern**

All references to labels which are not defined within the current module are automatically assumed to be references to globally-bound symbols in another module (i.e. *external* symbols). In some cases the assembler can generate better code if it knows how big the referenced object is (e.g. the global pointer, described earlier). An external object's size is specified using the **.extern** directive, as follows:

```

.externindex, 4
.externarray, 100
lw    $3, index    # load a 4 byte (1 word) external
lw    $2, array($3) # load part of a 100 byte external
sw    $2, value    # store in an unknown size external

```

### **.weakext**

Some assemblers and toolchains support the concept of *weak* global binding. This allows the program to specify a provisional binding for a symbol, which may be overridden if a normal, or *strong* global definition is encountered. For example:

```

.data
.weakext errno
errno: .word 0

.text
lw    $2,errno    # may use local or external
                    # definition

```

This module, and others which access *errno*, will use this local definition of *errno*, unless some other module also defines it with a **.globl**.

It is also possible to declare a local variable with one name, but make it weakly global with a different name:

```

.data
myerrno: .word0
.weakext errno, myerrno

.text
lw    $2,myerrno  # always use local definition
lw    $2,errno    # may use local definition, or
                    # other

```

## **Function directives**

Some MIPS assemblers expect the programmer to mark the start and end of each function, and describe the stack frame which it uses. In some toolchains this information is used by the debugger to perform stack backtraces and the like.

### **.ent, .end**

These directives mark the start and end of a function. A trivial *leaf* function might look like this:

```

.text
.ent    localfunc
localfunc:
    addu    v0,a1,a2    # return (arg1 + arg2)

```

```

j    ra
.end  localfunc

```

The label name may be omitted from the **.end** directive, which then defaults to the name used in the last **.ent**. Specifying the name explicitly allows the assembler to check that the programmer did not miss earlier **.ent** or **.end** directives.

### **.aent**

Some functions may provide multiple, alternative entry-points. The **.aent** directive identifies labels as such. For example:

```

.text
.globl memcpy
.ent  memcpy
memcpy:move  t0,a0          # swap first two arguments
      move  a0,a1
      move  a1,t0

      .globl bcopy
      .aent bcopy
bcopy: lb   t0,0(a0)      # very slow byte copy
      sb   t0,0(a1)
      addu a0,1
      addu a1,1
      subu a2,1
      bne  a2,zero,bcopy
      j   ra
      .end  memcpy

```

### **.frame, .mask, .fmask**

Most functions need to allocate a stack frame in which to:

- save the return address register (*\$31*);
- save any of the registers *s0 - s9* and *\$f20 - \$f31* which they modify (known as the *callee-saves* registers);
- store local variables and temporaries;
- pass arguments to other functions.

In some CISC architectures the stack frame allocation, and possibly register saving, is done by special purpose *enter* and *leave* instructions, but in the MIPS architecture it is coded by the compiler or assembly-language programmer. However debuggers need to know the layout of each stack frame to do stack backtraces and the like, and in the original MIPS Corp. toolchain these directives provided this information; in other toolchains they may be quietly ignored, and the stack layout determined at run-time by disassembling the function prologue. Putting them in the code is therefore not always essential, but does no harm and may make the code more portable. Many toolchains supply a header file *<asm.h>*, which provides C-style macros to generate the appropriate directives, as required (the procedure call protocol, and stack usage, is described in a later chapter).

The **.frame** directive takes 3 operands:

- *framereg*: the register used to access the local stack frame - usually *\$sp*.
- *returnreg*: the register which holds the return address. Usually this is *\$0*, which indicates that the return address is stored in the stack frame, or *\$31* if this is a *leaf* function (i.e. it doesn't call any other functions) and the return address is not saved.
- *framesize*: the total size of stack frame allocated by this function; it should always be the case that  $Sp + framesize = \text{previous } Sp$ .

```
.frame framereg, framesize, returnreg
```

The **.mask** directive indicates where the function saves general registers in the stack frame; **.fmask** does the same for floating-point registers. Their first argument is *regmask*, a bitmap of which registers are being saved (i.e. bit 1 set = \$1, bit 2 set = \$2, etc.); the second argument is *regoffset*, the distance from *framereg* + *framesize* to the start of the register save area.

```
.mask regmask, regoffset
.fmask fregmask, fregoffs
```

How these directives relate to the stack frame layout, and examples of their use, can be found in the next chapter. Remember that the directives do not create the stack frame, they just describe its layout; that code still has to be written explicitly by the compiler or assembly-language programmer.

### Assembler control (.set)

The original MIPS Corp. assembler is an ambitious program which performs intelligent macro expansion of synthetic instructions, delay-slot filling, peephole optimization, and sophisticated instruction reordering, or scheduling, to minimize pipeline stalls. Many assemblers will be less complex: modern optimizing compilers usually prefer to do these sort of optimizations themselves. However in the interests of source code compatibility, and to make the programmer's life easier, most MIPS assemblers perform macro expansion, insert extra **nops** as required to hide branch and load delay-slots, and prevent pipeline hazards in normal code (pipeline hazards are described in detail later).

With a reordering assembler it is sometimes necessary to restrict the reordering, to guarantee correct timing, or to account for side-effects of instructions which the assembler cannot know about (e.g. enabling and disabling interrupts). The **.set** directives provide this control.

#### **.set noreorder/reorder**

By default most assemblers are in *reorder* mode, which allow them to reorder instructions to avoid pipeline hazards and (perhaps) to achieve better performance; in this mode it will not allow the programmer to insert **nops**. Conversely, code that is in a *noreorder* region will not be optimized or changed in any way. This means that the programmer can completely control the instruction order, but the downside is that the code must now be scheduled manually, and delay slots filled with useful instructions or **nops**. For example:

```
.set noreorder
lw    t0, 0(a0)
nop                    # LDSLOT
subu  t0, 1
bne   t0, zero, loop
nop                    # BDSLOT
.set  reorder
```

#### **.set volatile/novolatile**

Any load or store instruction within a *volatile* region will not be moved with respect to other loads and stores. This can be important for accesses to memory mapped device registers, where the order of reads and writes is important. For example, if the following code fragment did not use **.set volatile**, then the assembler might decide to move the second **lw** before the **sw**, to fill the first load delay-slot. Hazard avoidance and other optimizations are not affected by this option.

```
.set volatile
lw    t0,0(a0)
sw    t0,0(a1)
lw    t1,4(a0)
.set novolatile
```

**.set noat/at**

The assembler reserves register *\$1* (known as the *assembler temporary*, or *\$at* register) to hold intermediate values when performing macro expansions; if code attempts to use the register, a warning or error message will be sent. It is not always obvious when the assembler will use *\$at*, and there are certain circumstances when the programmer may need to ensure that it does not (for example in exception handlers before *\$1* has been saved). Switching on **noat** will make the assembler generate an error message if it needs to use *\$1* in a macro instruction, and allows the programmer to use it explicitly without receiving warnings. For example:

```
xcptgen:
    .set noat
    subu k0,sp,XCP_SIZE
    sw   $at,XCP_AT(k0)
    .set at
```

**.set nomacro/macro**

Most of the time the programmer will not care whether an assembler statement generates more than one real machine instruction, but of course there are exceptions. For instance when manually filling a branch delay-slot in a *noreorder* region, it would almost certainly be wrong to use a complex macro instruction; if the branch was taken, only the first instruction of the macro would be executed. Switching on **nomacro** will cause a warning if any statement expands to more than one machine instruction. For example, compare the following two code fragments:

```
.set noreorder
blt  a1,a2,loop
.set nomacro
li   a0,0x1234    # BDSLOT
.set macro
.set reorder

.set noreorder
blt  a1,a2,loop
.set nomacro
li   a0,0x12345   # BDSLOT
.set macro
.set reorder
```

The first will assemble successfully, but the second will generate an assembler error message, because its **li** is expanded into two machine instructions (**lui** and **ori**). Some assemblers will catch this mistake automatically.

**.set nobopt/bopt**

Setting the **nobopt** control prevents the assembler from carrying out certain types of branch optimization. It is usually used only by compilers.

**THE COMPLETE GUIDE TO ASSEMBLER INSTRUCTIONS**

Table 9.2, “Assembler instructions” below shows, for every mnemonic defined by the MIPS assemblers for the R3000 (MIPS 1) instruction set, how it is likely to be implemented, and what it does.

Some naming conventions in the assembler may appear confusing:

- *Unsigned versions:* a “u” suffix on the assembler mnemonic is usually to be read as “unsigned”. Usually this follows the conventional meaning; but the most common u-suffix instructions are **addu** and **subu**: and here the u means that overflow into the sign bit will not cause a trap. Regular **add** is never generated by C compilers.

Many compilers, not expecting there to be a run-time system to handle overflow traps, will always use the “u” variant.

However, because the integer multiply instructions **mult** and **multu** generate 64-bit results the signed and unsigned versions are really different – and neither of the machine instructions produce a trap under any circumstances.

- *Immediate operands:* as mentioned above, the programmer can use immediate operands with most instructions (e.g. **add rd, rs, 1**); quite a few arithmetic/logic instructions really do have “immediate” versions (called **addi** etc.). Most assemblers do not require the programmer to explicitly know which machine instructions support immediate variants.
- *Building addresses, %lo\_ and %hi\_:* synthesis of addressing modes was described earlier. The table typically will list only one address-mode variant for each instruction in the table.
- *What it does:* the function of each instruction is described using “C” expression syntax; it is easy to get a rough idea, but a thorough knowledge of C allows the exact behavior to be understood.

The assembler descriptions use the following conventions:

Word	Used for
rs,rt	CPU registers used as operands
rd	CPU register which receives the result
fs,ft	floating point register operands
fd	floating point register which receives the result
imm	16-bit “immediate” constant
label	the name of an entry point in the instruction stream
addr	one of a number of different address expressions
%hi_addr	where addr is a symbol defined in the data segment, “%hi_addr” and “%lo_addr” are as described above; that is, they are the high and low parts of the value which can be used in an <b>lui/addui</b> sequence.
%lo_addr	
%gpoff_addr	the offset in the “small data” segment of an address
\$at	register \$1, the “assembler temporary” register
\$zero	register \$0, which always contains a zero value
\$ra	the “return address” register <b>\$31</b>
RETURN	the point to where control returns to after a subroutine call; this is the next instruction but one after the branch/jump to subroutine, and is normally loaded into \$ra by the “.. and link” instructions.
trap(CAUSE, code)	Take a CPU trap; “CAUSE” determines the setting of the Cause register, and “code” is a value not interpreted by the hardware, but which system software can obtain by looking at the trap instruction. CAUSE values can be BREAK; FPINT (for floating point exception); SYSCALL.

**Table 9.1: Assembler register and identifier conventions**

Word	Used for
unordered(fs,ft)	some exceptional floating point values cannot be sensibly compared; it is not sensible to ask whether one NaN is bigger than another (NaN, “not a number”, is produced when the result of an operation is not defined). The IEEE754 standard requires that for such a pair that “fs <ft”, “fs == ft” and “fs > ft” shall all be false. “unordered(fs,ft)” returns true for an unordered pair, false otherwise.
fpcond	the floating point “condition bit” found in the FP control/status register, and tested by the <b>bc1f</b> and <b>bc0t</b> instructions.

**Table 9.1: Assembler register and identifier conventions**

Assembler	Expands To	What it does
move rd,rs	addu rd,rs,\$zero	rd = rs;
Branch (PC-relative, all conditional)		
b label	beq \$zero,\$zero,label	goto label;
beq rs,rt,label		if (rs == rt) goto label;
bge rs,rt,label	slt \$at,rs,rt beq \$at,\$zero,label	if ((signed) rs >= (signed) rt) goto label;
bgeu rs,rt,label	sltu \$at,rs,rt beq \$at,\$zero,label	if ((unsigned) rs >= (unsigned) rt) goto label;
bgt rs,rt,label	slt \$at,rt,rs bne \$at,\$zero,label	if ((signed) rs > (signed) rt) goto label;
bgtu rs,rt,label	slt \$at,rt,rs beq \$at,\$zero,label	if ((unsigned) rs > (unsigned) rt) goto label;
ble rs,rt,label	sltu \$at,rt,rs beq \$at,\$zero,label	if ((signed) rs <= (signed) rt) goto label;
bleu rs,rt,label	sltu \$at,rt,rs beq \$at,\$zero,label	if ((unsigned) rs <= (unsigned) rt) goto label;
blt rs,rt,label	slt \$at,rs,rt bne \$at,\$zero,label	if ((signed) rs <(signed) rt) goto label;
bltu rs,rt,label	sltu \$at,rs,rt bne \$at,\$zero,label	if ((unsigned) rs <(unsigned) rt) goto label;
bne rs,rt,label		if (rs != rt) goto label;
beqz rs,label	beq rs,\$zero,label	if (rs == 0) goto label;
bgez rs,label		if ((signed) rs >= 0) goto label;
bgtz rs,label		if ((signed) rs > 0) goto label;
blez rs,label		if ((signed) rs <= 0) goto label;

**Table 9.2: Assembler instructions**



Assembler	Expands To	What it does
bltz rs,label		if ((signed) rs <0) goto label;
bnez rs,label	bne rs,\$zero,label	if (rs != 0) goto label;
bal label	bgezal \$zero,label	ra = RETURN; goto label;
bgezal rs,label		if ((signed) rs >= 0) { ra = RETURN; goto label; }
bltzal rs,label		if ((signed) rs <0) { ra = RETURN; goto label; }
Unary arithmetic/logic instructions		
abs rd,rs	sra \$at,rs,31 xor rd,rs,\$at sub rd,rd,\$at	rd = rs <0 ? -rs: rs;
abs rd	sra \$at,rd,31 xor rd,rd,\$at sub rd,rd,\$at	rd = rd <0 ? -rd: rd;
neg rd,rs	sub rd,\$zero,rs	rd = -rs; /* trap on overflow */
neg rd	sub rd,\$zero,rd	rd = -rd; /* trap on overflow */
negu rd,rs	subu rd,\$zero,rs	rd = -rs; /* no trap */
negu rd	subu rd,\$zero,rd	rd = -rd; /* no trap */
not rd,rs	nor rd,rs,\$zero	rd = ~rs;
not rd	nor rd,rd,\$zero	rd = ~rd;
Binary arithmetic/logical operations		
add rd,rs,rt		rd = rs + rt; /* trap on overflow */
add rd,rs	add rd,rd,rs	rd += rs; /* trap on overflow */
addu rd,rs,rt		rd = rs + rt; /* no trap on overflow */
addu rd,rs		rd += rs; /* no trap on overflow */
and rd,rs,rt		rd = rs & rt;
and rd,rs	and rd,rd,rs	rd &= rs;

Table 9.2: Assembler instructions

Assembler	Expands To	What it does
div rd,rs,rt	div rs,rt bne rt,\$zero,1f nop break 7 1: li \$at,-1 bne rt,\$at,2f nop lui \$at,0x8000 bne rs,\$at,2f nop break 6 2: mflo rd	rd = rs/rt;  /* trap divide by zero */    /* trap overflow conditions */
div rd,rs	as above	rd = rd/rt; /* trap on errors */
divu rd,rs,rt	divu rs,rt bne rt,\$zero,1f nop break 7 1: mflo rd	rd = rs/rt;  /* trap on divide by zero */  /* no check for overflow */
or rd,rs,rt		rd = rs   rt;
mul rd,rs,rt	multu rs,rt mflo rd	rd = rs*rt; /* no checks */
mulo rd,rs,rt	mult rs,rt mfhi rd sra rd,rd,31 mflo \$at beq rd,\$at,1f nop break 6 1: mflo rd	rd = rs * rt; /* signed */    /* trap on overflow */
mulou rd,rs,rt	multu rs,rt mfhi \$at mflo rd beq \$at,\$zero,1f nop break 6 1:	rd = (unsigned) rs * rt;   /* trap on overflow */
nor rd,rs,rt		rd = ~(rs   rt);

Table 9.2: Assembler instructions

Assembler	Expands To	What it does
rem rd,rs,rt	div rs,rt bne rt,\$zero,1f nop break 7 1: li \$at,-1 bne rt,\$at,2f nop lui \$at,0x8000 bne rs,\$at,2f nop break 6 2: mfhi rd	rd = rs%rt;  /* trap if rt == 0 */      /* trap if it will overflow */
remu rd,rs,rt	divu rs,rt bne rt,\$zero,1f nop break 7 1: mfhi rd	/* unsigned operation, ignore overflow */ rd = rs%rt;  /* trap if rt == 0 */
rol rd,rs,rt	negu \$at,rt srlv \$at,rs,\$at sllv rd,rs,rt or rd,rd,\$at	/* rd = rs rotated left by rt */
ror rd,rs,rt	negu \$at,rt sllv \$at,rs,\$at srlv rd,rs,rt or rd,rd,\$at	/* rd = rs rotated right by rt */
seq rd,rs,rt	xor rd,rs,rt sltiu rd,rd,1	rd = (rs == rt) ? 1: 0;
sge rd,rs,rt	slt rd,rs,rt xori rd,rd,1	rd = ((signed)rs >= (signed)rt) ? 1: 0;
sgeu rd,rs,rt	sltu rd,rs,rt xori rd,rd,1	rd = ((unsigned)rs >= (unsigned)rt) ? 1: 0;
sgt rd,rs,rt	slt rd,rt,rs	rd = ((signed)rs > (signed)rt) ? 1: 0;
sgtu rd,rs,rt	sltu rd,rt,rs	rd = ((unsigned)rs > (unsigned)rt) ? 1: 0;
sle rd,rs,rt	slt rd,rt,rs xori rd,rd,1	rd = ((signed)rs <= (signed)rt) ? 1: 0;
sleu rd,rs,rt	sltu rd,rt,rs xori rd,rd,1	rd = ((unsigned)rs <= (unsigned)rt) ? 1: 0;
slt rd,rs,rt		rd = ((signed)rs < (signed)rt) ? 1: 0;
sltu rd,rs,rt	sltu rd,rs,rt xor rd,rs,rt	rd = ((unsigned)rs < (unsigned)rt) ? 1: 0;
sne rd,rs,rt	sltu rd,\$zero,rd	rd = (rs == rt) ? 1: 0;

Table 9.2: Assembler instructions

Assembler	Expands To	What it does
sll rd,rs,rt	sllv rd,rs,rt	rd = rs <<rt;
sra rd,rs,rt	srav rd,rs,rt	rd = ((signed) rs) >> rt;
srl rd,rs,rt	srlv rd,rs,rt	rd = ((unsigned) rs) >> rt;
sub rd,rs,rt	sub rd,rs,rt	rd = rs - rt; /* trap on overflow */
subu rd,rs,rt	subu rd,rs,rt	rd = rs - rt; /* no trap on overflow */
xor rd,rs,rt	xor rd,rs,rt	rd = rs ^ rt;
Binary instructions with one constant operand ("immediate") <b>addi</b> opcode is legal but unnecessary		
add rd,rs,imm	addi rd,rs,imm	/* "add" traps on overflow */ /* when -32768 <= imm <32768 */ rd = rs + (signed) imm;
	lui rd,hi_imm ori rd,rd,lo_imm add rd,rs,rd	/* for big values add and ALL signed ops * expand like this */ rd = imm & 0xFFFF0000; rd  = imm & 0xFFFF; rd = rs + rd;
addu rd,rs,imm	addiu rd,rs,imm	/* "addu" won't trap on overflow */ /* will expand if imm bigger than 16 bit */ rd = rs + (signed) imm;
sub rd,rs,imm	addi rd,rs,-imm	/* trap on overflow */ /* will expand if imm bigger than 16 bit */ rd = rs - (signed) imm;
subu rd,rs,imm	addiu rd,rs,-imm	/* no trap on overflow */ /* will expand if imm bigger than 16 bit */ rd = rs - (signed) imm;
and rd,rs,imm	andi rd,rs,imm	rd = rs & imm; /* 0 <= imm <65535 */
	lui rd,hi_imm ori rd,rd,lo_imm and rd,rs,rd	/* for big values add and ALL unsigned ops * expand like this */ rd = imm & 0xFFFF0000; rd  = imm & 0xFFFF; rd = rs & rd;
or rd,rs,imm	ori rd,rs,imm	rd = rs   imm; /* 0 <= imm <65535 */
slt rd,rs,imm	slti rd,rs,imm	/* -32768 <= imm <32768 */ rd = ((signed) rs <(signed) imm) ? 1: 0; /* expanded as for add if imm big */
sltu rd,rs,imm	sltiu rd,rs,imm	rd = ((unsigned) rs <(unsigned) imm) ? 1: 0; /* expanded as for "and" if imm big */
xor rd,rs,imm	xori rd,rs,imm	rd = rs ^ imm;
li rd,imm	ori rd,\$zero,imm	rd = (unsigned) imm; /* imm <= 65335 */
	lui rd,hi_imm ori rd,\$zero,lo_imm	/* for big imm value expand to... */ rd = imm & 0xFFFF0000; rd  = imm & 0xFFFF;
lui rd,imm		rd = imm << 32;
Multiply/divide unit machine instructions		

Table 9.2: Assembler instructions

Assembler	Expands To	What it does
mult rs,rt		/* Start signed multiply of rs and rd. * Result can be retrieved, in a while, * using mfhi/mflo */
multu rs,rt		/* start unsigned multiply of rs and rd */
divd rs,rt		/* start signed divide rs/rd */
divdu rs,rt		/* start unsigned divide rs/rd */
mfhi rd		/* retrieve remainder from divide or high- * order word of result of multiply */
mflo rd		/* retrieve result of divide or low-order * word of result of multiply */
mthi rs		/* load multiply unit "hi" register */
mtlo rs		/* load multiply unit "lo" register */
Unconditional (absolute) branch and call		
jal label		ra = RETURN; goto label;
jalr rd,rs		rd = RETURN; goto *rs;
jalr rs	jalr rs,\$ra	ra = RETURN; goto *rs;
jal rd,addr	lui \$at,%hi_addr addiu \$at,\$at,%lo_addr jalr rd,\$at	rs = RETURN; goto label; goto *at;
j label		goto label;
jr rs		goto *rs;
No-op		
nop	sll \$zero,\$zero,\$zero	/* no-op, instruction code == 0 */
Load address		
la rd,label	lui rd,%hi_label addiu rd,rd,%lo_label	rd = %hi_addr <<32 rd += (signed) %lo_label;
Address mode implementation for load/store		
lw rd,label	lui rd,%hi_label lw rd,%lo_label(rd)	/* link-time determined location */ /* note can use rd or \$at for lw */
	lw rd,%gpoff_addr(\$gp )	/* link-time location, in gp segment */
lw rd,offset(rs)	lw rd,offset(rsO)	/* single instruction if offset fits * in 16 bits */
	lui rd,%hi_offset addu rd,rd,rs lw rd,%lo_offset(rd)	/* sequence for big offset */
Load and store instructions		

Table 9.2: Assembler instructions

Assembler	Expands To	What it does
lw rd,addr		/* load word */ rd = *((int *) addr);
lh rd,addr		/* load half-word,sign-extend */ rd = *((short *) addr);
lhu rd,addr		/* load half-word,zero-extend */ rd = *((unsigned short *) addr);
lb rd,addr		/* load byte, sign-extend */ rd = *((signed char *) addr);
lbu rd,addr		/* load byte, sign-extend */ rd = *((unsigned char *) addr);
ld \$t2,addr	lui \$at,%hi_addr addiu \$at,\$at,%lo_addr lw \$t2,0(\$at) lw \$t3,4(\$at)	/* load 64-bit integer into pair of regs */
sw rs,addr		/* store word */ *((int *) addr) = rs;
sh rs,addr		/* store half-word */ *((short *) addr) = rs;
sb rs,addr		/* store byte */ *((char *) addr) = rs;
sd \$t2,addr	lui \$at,%hi_addr addiu \$at,\$at,%lo_addr sw \$t2,0(\$at) sw \$t3,4(\$at)	/* store 64-bit integer */
ulw rd,addr	lui \$at,%hi_addr addiu \$at,\$at,%lo_addr lwl rd,0(\$at) lwr rd,3(\$at)	/* load word unaligned */  /* if addr is aligned, does same load * twice */
usw rs,addr	lui \$at,%hi_addr addiu \$at,\$at,%lo_addr swl rs,0(\$at) swr rs,3(\$at)	/* store word unaligned */  /* if addr is aligned, does same store * twice */
lwl rd,addr		load/store word left/right, see "Unaligned loads and store" on page 1-5
lwr rd,addr		
swl rs,addr		
swr rs,addr		
l.s fd,addr	lui \$at,%hi_addr lwc1 fd,%lo_addr(\$at)	/* load FP single */ fd = *((float *) addr);
l.d \$f6,addr	lui \$at,%hi_addr addiu \$at,\$at,%lo_addr lwc1 \$f7,0(\$at) lwc1 \$f6,4(\$at)	/* load FP double into reg pair */ fd = *((double *) addr);
s.s fs,addr	swc1 fs,addr	/* store FP single */ *((float *) addr) = fs;

Table 9.2: Assembler instructions

Assembler	Expands To	What it does
s.d \$f2,addr	lui \$at,%hi_addr addiu \$at,\$at,%lo_addr swc1 \$f3,0(\$at) swc1 \$f2,4(\$at)	/* store FP double from reg pair */ *((double *) addr) = fs;
Co-processor “condition” tests		
bc0t label bc2t label bc3t label		/* goto label if corresponding BrCond * input is active */
bc0f label bc2f label bc3f label		/* goto label if corresponding BrCond * input is inactive */
Trap instructions		
break code		trap(BREAK, code);
syscall		trap(SYSCALL, 0)
teq rs,rt,code	bne rs,rt,1f nop break code 1:	/* R4000 compatibility instruction */ if (rs == rt) trap(BREAK, code);
tge rs,rt,code	slt \$at,rs,rt bne \$at,\$zero,1f nop break code 1:	if ((signed)rs >= (signed)rt) trap(BREAK, code);
tgeu rs,rt,code	sltu \$at,rs,rt bne \$at,\$zero,1f nop break code 1:	if ((unsigned)rs >= (unsigned)rt) trap(BREAK, code);
slt rs,rt,code	slt \$at,rs,rt beq \$at,\$zero,1f nop break code 1:	if ((signed)rs <(signed)rt) trap(BREAK, code);
sltu rs,rt,code	sltu \$at,rs,rt beq \$at,\$zero,1f nop break code 1:	if ((unsigned)rs <(unsigned)rt) trap(BREAK, code);
tne rs,rt,code	beq rs,rt,1f nop break code 1:	if (rs != rt) trap(BREAK, code);
Floating point instructions. All come in both “.d” (64-bit) and “.s” (32-bit) forms Only “.d” listed.		
Test and set condition flag instructions		
c.f.d		if (unordered(fs,ft)) trap(FPINT); fpcond = 0;
c.sf.d		fpcond = 0;

Table 9.2: Assembler instructions

Assembler	Expands To	What it does
c.un.d		if (unordered(fs,ft)) trap(FPINT); fpcond = unordered(fs,ft);
c.ngle.d		fpcond = unordered(fs,ft);
c.eq.d		if (unordered(fs,ft)) trap(FPINT); fpcond = (fs == ft);
c.seq.d		fpcond = (fs == ft);
c.ueq.d		if (unordered(fs,ft)) fpcond = (fs == ft)    unordered(fs,ft);
c.ngl.d		fpcond = (fs == ft)    unordered(fs,ft);
c.olt.d		if (unordered(fs,ft)) trap(FPINT); fpcond = (fs < ft);
c.lt.d		fpcond = (fs < ft);
c.ult.d		if (unordered(fs,ft)) trap(FPINT); fpcond = (fs < ft)    unordered(fs,ft);
c.nge.d		fpcond = (fs < ft)    unordered(fs,ft);
c.ole.d		if (unordered(fs,ft)) trap(FPINT); fpcond = (fs <= ft);
c.le.d		fpcond = (fs <= ft);
c.ule.d		if (unordered(fs,ft)) trap(FPINT); fpcond = (fs <= ft)    unordered(fs,ft);
c.ngt.d		fpcond = (fs <= ft)    unordered(fs,ft);
FP move		
mov.d fd,fs		fd = fs;
Unary arithmetic. These operations are implemented by operating only on the sign bit, so never worry about invalid values, and they never trap.		
abs.d fd,fs		fd = (fs > 0) ? fs: -fs;
abs.d fd	abs.d fd,fd	fd = (fd > 0) ? fd: -fd;
neg.d fd,fs		fd = -fs;
neg.d fd	neg.d fd,fd	fd = -fd;
Convert between formats cvt.X.Y should be read "convert TO X FROM Y"		
cvt.d.s fd,fs		fd = (double) ((float) fs);
cvt.d.s fd	cvt.d.s fd,fd	fd = (double) ((float) fd);
cvt.d.w fd,fs		fd = (double) ((int) fs);
cvt.d.w fd	cvt.d. fd,fs	fd = (double) ((int) fd);
cvt.s.d fd,fs		fd = (float) ((double) fs);
cvt.s.d fd	cvt.s.d fd,fd	fd = (float) ((double) fd);

Table 9.2: Assembler instructions



Assembler	Expands To	What it does
cvt.s.w fd,fs		fd = (float)((int) fs);
cvt.s.w fd	cvt.s.w fd,fd	fd = (float)((int) fd);
cvt.w.d fd,fs		/* note integer value is chosen * according to rounding mode */ fd = (int)((double) fs);
cvt.w.d fd	cvt.w.d fd,fd	fd = (int)((double) fd);
cvt.w.s fd,fs		fd = (int)((float) fs);
cvt.w.s fd	cvt.w.s fd,fd	fd = (int)((float) fd);
Convert from floating-point to integer using an explicit rounding mode. <i>Note: rt is used as a temporary.</i>		
ceil.w.d fd,fs,rt	cfc1 rt,\$S31 nop ori \$at,rt,3 xori \$at,\$at,1 ctc1 \$at,\$S31 nop cvt.w.d fd,fs ctc1 rt,\$S31	fd = ceil((double) fd);
floor.w.d fd,fs,rt	cfc1 rt,\$S31 nop ori \$at,rt,3 xori \$at,\$at,0 ctc1 \$at,\$S31 nop cvt.w.d fd,fs ctc1 rt,\$S31	fd = floor((double) fd);
round.w.d fd,fs,rt	cfc1 rt,\$S31 nop ori \$at,rt,3 xori \$at,\$at,2 ctc1 \$at,\$S31 nop cvt.w.d fd,fs ctc1 rt,\$S31	fd = round((double) fd);
trunc.w.d fd,fs,rt	cfc1 rt,\$S31 nop ori \$at,rt,3 xori \$at,\$at,2 ctc1 \$at,\$S31 nop cvt.w.d fd,fs ctc1 rt,\$S31	fd = (int) ((double) fd);
ceil.w.s fd,fs,rt	<b>see above</b>	fd = ceil((float) fd);
floor.w.s fd,fs,rt	<b>see above</b>	fd = floor((float) fd);
round.w.s fd,fs,rt	<b>see above</b>	fd = round((float) fd);
trunc.w.s fd,fs,rt	<b>see above</b>	fd = (int) ((float) fd);
Arithmetic operations all can trap under some circumstances		

Table 9.2: Assembler instructions

Assembler	Expands To	What it does
add.d fd,fs,ft		fd = fs + ft;
add.d fd,fs	add.d fd,fd,fs	fd += fs;
div.d fd,fs,ft		fd = fs/ft;
div.d fd,fs	div.d fd,fd,,fs	fd /= fs;
mul.d fd,fs,ft		fd = fs*ft;
mul.d fd,fs	mul.d fd,fd,fs	fd *= fs;
sub.d fd,fs,ft		fd = fs - ft;
sub.d fd,fs	sub.d fd,fd,fs	fd -= fs;
Conditional branch following test		
bc1f label		if (!fpcond) goto label;
bc1t label		if (fpcond) goto label;
Move data between FP and integer register		
mfc1 rd,fs		/* no format conversion done, just copies * bits. Can use odd-numbered fp registers */ rd = fs;
mtc1 rs,fd		/* no format conversion done, just copies * bits. Can use odd-numbered fp registers */ fd = rs;
mfc1.d \$t2,\$f2	mfc1 \$t2,\$f3 mfc1 \$t3,\$f2	/* move a double value (just bits, no * conversion) from integer register pair *to FP reg pair */
mtc1.d \$t2,\$f2	mtc1 \$t2,\$f3 mtc1 \$t3,\$f2	/* move a double value (just bits, no * conversion)from integer register pair *to FP reg pair */
CPU control instructions (privileged mode only)		
mfc0 rd, nn		rd = (contents of CPU control reg nn);
mtc0 rs, nn		(CPU control reg nn) = rs;
tlbr tlbwi tlbwr tlbpr		These instructions are used to setup the TLB (memory management hardware) and are described in Chapters 2 & 3.
rfe		Used at the end of an exception routine Restores kernel-mode and global interrupt enable bits from the 3-level "stack" in the status register SR. See chapter 3.

Table 9.2: Assembler instructions

## ALPHABETIC LIST OF ASSEMBLER INSTRUCTIONS

In this list real hardware instructions are marked with a dagger.

**abs rd,rs**: integer absolute value

**abs.d fd,fs†**: FP double precision absolute value

**abs.s fd,fs†**: FP single precision absolute value

---

```

add rd,rs,rt_imm†: add, trap on overflow
add.d fd,fs,ft†: FP double precision add
add.s fd,fs1,fs2†: FP single precision add
addi rd,rs,imm†: add immediate, trap on overflow
addiu rd,rs,imm†: add immediate, never trap
addu rd,rs,rt_imm†: add, never trap
and rd,rs,rt_imm†: logical AND
andi rd,rs,imm†: logical AND immediate
bal label: PC-relative subroutine call
bc0f offset†: branch if CPCOND input signal inactive
bc0t offset†: branch if CPCOND input signal active
bc1f label†: branch if FP condition bit clear
bc1t label†: branch if FP condition bit set
beq rs,rt,label†: branch if rs == rt
beqz rs,label: branch if rs is zero
bge rs,rt,label: branch if rs ≥ rt (signed compare)
bgeu rs,rt,label: branch if rs ≥ rt (unsigned compare)
bgez rs,label†: branch if rs ≥ 0 (signed)
bgezal rs,label†: branch to subroutine if rs == 0
bgt rs,rt,label: branch if rs > rt (signed)
bgtu rs,rt,label: branch if rs > rt (unsigned)
bgtz rs,label†: branch if rs > 0 (signed)
ble rs,rt,label: branch if rs ≤ rt (signed)
bleu rs,rt,label: branch if rs ≤ rt (unsigned)
blez rs,label†: branch if rs ≤ 0 (signed)
blt rs,rt,label: branch rs <rt (signed)
bltu rs,rt,label: branch rs <rt (unsigned)
bltz rs,label†: branch if rs <0 (signed)
bltzal rs,label†: branch to subroutine if rs <0 (signed)
bne rs,rt,label†: branch if rs not equal to rt
bnez rs,label: branch if rs not zero
break†: trap with ``breakpoint`` Cause field
c.XXX.d fs1,fs2†: FP compare, set FP condition (double).
c.XXX.s fs1,fs2†: FP compare, set FP condition (single)
cfcl rd, crs†: move FP control register ``crs`` contents to rd
ctcl rs, crd†: move rs contents to FP control register ``crs``
cvt.X.Y fd,fs†: FP convert from format Y to X. Y and X can be
``d`` for double-precision, ``s`` for single-precision, and
``w`` for 32-bit signed integer value held in an FP register.
div rd,rs,rt†: rd = rs/rt, trap division by zero or overflow
div.d fd,fs,ft†: FP double precision divide
div.s fd,fs1,fs2†: FP single precision divide
divu rd,rs,rt†: rd = rs/rt; trap divide by zero but not
overflow
j label†: jump to label
jal label†: call subroutine at label (return address in ra/
$31)
jal rd,label: call subroutine but put return address in rd
jalr rs†: call subroutine who's address is in rs (return in
ra/$31)
jalr rd,rs†: call subroutine at rs but put return address in
rd
jr rs†: indirect jump to address stored in rs
l.d fd, offset(rs): load 64 bits to FP register
l.s fd, offset(rs): load 32 bits to FP register
la rd,label: load rd with address of label
lb rd,offset(rs)†: load byte from memory and sign-extend
lbu rd,offset(rs)†: load byte from memory and zero-extend
lh rd,offset(rs)†: load half-word (16bits) from memory and
sign-extend
lhu rd,offset(rs)†: load half-word (16bits) from memory and
sign-extend

```

---

---

```

li rd,imm: load constant value ``imm`` into rd
lui rd,imm†: load ``imm`` into the high bits of rd, zeroing
low bits
lw rd,offset(rs)†: load word (32bits) into register
lwcl fd,offset(rs)†: load 32-bits from memory to FP register
lwl rd,offset(rs)†: load word left, used for unaligned loads.
lwr rd,offset(rs)†: load word right, used for unaligned loads.
mfc0 rd, crs†: move contents of CPU control register crs to rd
mfc1 rd,fs†: move contents of FP register fs to rd
mfc1.d rd,fs: move contents of FP register pair fs to rd and
next reg
mfhi rd†: put multiply result high word or divide's remainder
in rd
mflo rd†: put multiply result low word or divide result in rd
mov.d fd,fs†: move FP double from fs to fd
mov.s fd,fs†: move FP single from fs to fd
move rd,rs: move data from register rs to rd
mtc0 rs, crd†: put contents of rs into CPU control register
crd
mtc1 rs,fd†: put bits from rs into FP register
mtc1.d $t2,$f2: put 64 bits from register pair starting at rs
to FP register
mthi rs†: put contents of rs into multiply unit ``hi``
register
mtlo rs†: put contents of rs into multiply unit ``lo``
register
mul rd,rs,rt: rd = rs*rt, signed multiply, no overflow trap
mul.d fd,fs,ft†: FP double precision multiply
mul.s fd,fs1,fs2†: FP single precision multiply
mulo rd,rs,rt: rd = rs*rt, signed, will trap if overflows
mulou rd,rs,rt: rd = rs*rt unsigned, will trap if overflows
mult rs,rt†: start multiplying rs*rt as signed values
multu rs1, rs2†: start multiplying rs*rt as unsigned values
neg rd,rs: rd = -rs, trap on overflow
neg.d fd,fs†: fd = -fs, double FP, never traps
neg.s fd,fs†: fd = -fs, single FP, never traps
negu rd,rs: rd = -rs, no overflow check
nor rd,rs,rt†: rd = logical NOR of rs and rt
not rd,rs: rd = ~rs, logical NOT
or rd,rs,rt_imm†: rd = rs | rt, logical OR
ori rd,rs,imm†: logical OR, immediate form (don't need to code
this)
rem rd,rs,rt: rd = remainder of rs/rt, signed, trap divide by
zero and overflow
remu rd,rs,rt: rd = remainder of rs/rt, unsigned, trap divide
by zero
rfe†: restores CPU status register at end of exception
processing
rol rd,rs,rt: rd = rs rotated left by rt
ror rd,rs,rt: rd = rs rotated right by rt
s.d fs,offset(rs): store 64 bits from FP register
s.s fs,offset(rs): store 32 bits from FP register
sb rs2,offset(rs1)†: store byte to memory
seq rd,rs,rt: set rd to 1 if rs == rt, 0 otherwise
sge rd,rs,rt: set rd to 1 if rs ≥ rt (signed), 0 otherwise
sgeu rd,rs,rt: set rd to 1 if rs ≥ rt (unsigned), 0 otherwise
sgt rd,rs,rt: set rd to 1 if rs > rt (signed), 0 otherwise
sgtu rd,rs,rt: set rd to 1 if rs > rt (unsigned), 0 otherwise
sh rs2,offset(rs1)†: store half-word (16bits) to memory
sle rd,rs,rt: set rd to 1 if rs ≤ rt (signed), 0 otherwise
sleu rd,rs,rt: set rd to 1 if rs ≤ rt (unsigned), 0 otherwise
sll rd,rs,rt†: rd = rs shifted left (bigger) by rt (max 31)

```

---

---

**sllv rd,rs1,rs2†**: rd = rs shifted left (bigger) by rt (max 31)  
**slt rd,rs,rt\_imm†**: set rd to 1 if rs <rt\_imm (unsigned), 0 otherwise  
**slti rd,rs,imm†**: set rd to 1 if rs <imm (signed), 0 otherwise  
**sltiu rd,rs,imm†**: set rd to 1 if rs <imm (unsigned), 0 otherwise  
**sltu rd,rs,rt\_imm†**: set rd to 1 if rs <rt\_imm (unsigned), 0 otherwise  
**sne rd,rs,rt**: set rd to 1 if rs not equal to rt, 0 otherwise  
**sra rd,rs,rt†**: rd = rs shifted right by rt, sign bit propagates down  
**srav rd,rs,rt†**: rd = rs shifted right by rt, sign bit propagates down  
**srl rd,rs,rt†**: rd = rs shifted right by rt, zeroes from top  
**srlv rd,rs,rt†**: rd = rs shifted right by rt, zeroes from top  
**sub rd,rs,rt\_imm†**: rd = rs - rt\_imm, trap if overflows  
**sub.d fd,fs,ft†**: FP double precision subtract  
**sub.s fd,fs1,fs2†**: FP single precision subtract  
**subu rd,rs,rt†**: rd = rs - rt, no trap on overflow  
**sw rs2,offset(rs1)†**: store word (32 bits) to memory  
**swcl fs, offset(rs)†**: store FP register value to memory  
**swl rs2,offset(rs1)†**: store word left, used for unaligned stores  
**swr rs2,offset(rs1)†**: store word right, used for unaligned stores  
**syscall†**: trap with a ``syscall`` cause value  
**tlbp†**: TLB (memory management unit) maintenance instruction  
**tlbr†**: TLB (memory management unit) maintenance instruction  
**tlbwi†**: TLB (memory management unit) maintenance instruction  
**tlbwr†**: TLB (memory management unit) maintenance instruction  
**xor rd,rs,rt\_imm†**: rd = bitwise exclusive-OR of rs and rt\_imm  
**xori rd,rs,imm†**: explicit immediate form of ``xor``

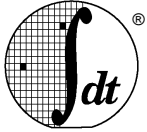

An efficient C run-time environment relies on conventions (enforced by compilers and assembly language programmers) about register usage within C-compatible functions.

## **THE STACK, SUBROUTINE LINKAGE, PARAMETER PASSING**

Many MIPS programs are written in mixed languages – for embedded systems programmers, this is most likely to be a mix of C (maybe C++) and assembler.

From the very start MIPS Corporation established a set of conventions about how to pass arguments to functions (pass parameters to subroutines'), and how to return values from functions.

These complex conventions start off quite simply: all arguments are allocated space in a data structure on the stack, but the first few arguments are placed in CPU registers and the stack contents left undefined. In practice, this optimization means that for most function calls the arguments are all passed in registers; but the stack data structure is the best starting point for understanding the process.

### **Stack Argument structure**

The MIPS hardware does not directly support a stack, but the calling convention requires one. The stack is grown downwards and the current stack bottom is kept in register *sp* (alias \$29). Any OS which is providing protection and security will make no assumptions about the user's stack, and the value of *sp* doesn't really matter except at the point where a function is called. But it is conventional to keep *sp* at or below the lowest stack location your function has used.

At the point where a function is called *sp* must be 8-byte aligned (not required by R3000 CPU hardware, but defined to simplify future compatibility and part of the rules).

So, to call a subroutine according to the MIPS standard, the caller creates a data structure on the stack to hold the arguments and sets *sp* to point to it. The first argument (left-most in the C source) is lowest in memory. Each argument is expanded to at least 1 word (32 bits); *double* (double-precision, 64-bit, floating point) values are aligned on an 8-byte boundary (as are data structures which contain a *double* field).

The argument structure really does look like a C *struct*, but there are two differences:

- There are always at least 16 bytes of the structure, even if the arguments would fit in less;
- each partial word (*char* or *short*) argument appears in the structure as what is effectively an *int* in memory. This does not apply to partial-word fields inside a *struct* argument.

### **Which arguments go in what registers**

Arguments assigned in the first 16 bytes (4 words) of the argument structure are passed in registers, and the caller can and does leave the first 16 bytes of the structure undefined. The called function can save the values back in memory if it needs to reconstruct memory-held arguments.

The four words of register argument values go in *a0* through *a3* respectively (\$4 through \$7), except where the caller can be sure that the data would be better loaded into floating point (FP) registers. The criteria for using FP registers can seem mystifying, but the rules are actually straight-forward:

- *First value must be FP*: unless the first argument takes a FP value, the FP registers are not used. This ensures that traditional functions like *printf* still work, although the number and type of arguments are variable. Moreover, it is relatively harmless: the majority of simple FP routines take only FP arguments.
- *Only two FP values may be passed in registers*: and will be in FP registers \$f12 and \$f14 (implicitly using \$f13 and \$f15 for double-precision values).

Two *doubles* occupy 16 bytes, which is all the data anyone expected to be in registers. Historically, functions with lots of single-precision arguments are not frequent enough to make another rule.

Just one more consideration: if a function returns a structure type, then the return-value convention involves the invention of a pointer as the implicit first argument before the first (visible) argument; this is described in detail below.

## Examples from the C library

```
thesame = strcmp("bear", "bearer", 4);
```

Leads to an argument structure whose fields are allocated as:

Location	Contents	In register
sp+12	<undefined>	-
sp+8	4	a2
sp+4	address of "bearer"	a1
sp+0	address of "bear"	a0

There are less than 16 bytes of arguments, so they all fit in registers.

That seems like a complex way of deciding to put three arguments into the usual registers. However, its value is clearer in the case of something a bit more tricky from the math library:

```
double ldexp (double, int);

y = ldexp(x, 23); /* y = x * (2**23) */
```

The arguments come out as

Location	Contents	In register
sp+12	<undefined>	-
sp+8	23	a2
sp+4	(double) x	\$f12/\$f13
sp+0		

## Exotic example; passing structures

C allows the programmer to use structure types as arguments (it is much more common practice to pass pointers to structures instead, but the language supports both). In MIPS the structure forms part of the "argument structure". In the following example:

```
struct thing {
    char letter;
    short count;
    int value;
} = {"z", 46, 100000};
```

```
(void) processthing (thing);
```

Location	Contents	In register
sp+4	100000	a1
sp+0	"z" <pad> 46	a0

In a big-endian CPU, the result of this is that the *char* value in the structure should end up in the most-significant 8 bits of the argument register, but packed together with the *short*.

## How printf() and varargs work

Consider this example:

```
printf ("length = %f, width = %f, num = %dn", 1.414, 1.0, 12);
```

Location	Contents	In register
sp+24	12	<value here>
sp+20	(double) 1.0	<value here>
sp+16		
sp+12	(double) 1.414	a3
sp+8		a2
sp+4	<padding>	-
sp+0	pointer to format string	a0

### Note:

- The padding at *sp + 4* is required to get correct alignment of the *double* values (the C rule is that floating point arguments are always passed as *double* unless the programmer explicitly asks otherwise with a *typedef* or function prototype).
- Because the first argument is not a floating point value, the compiler doesn't use an FP register for the second argument either. The data will instead be loaded into the two registers *a2* and *a3*.

This turns out to be very useful.

The *printf()* subroutine is defined with the "stdarg" or "varargs" macro package, which provides a portable cover for the register and stack manipulation involved. The *printf* routine picks off the arguments by taking the address of the first or second argument, and then can advance up the argument structure to find further arguments.

However, the macro package also has to persuade the C compiler to copy *a0* through *a3* into their "shadow" locations in the argument structure. Some compilers will detect the use of the address of an argument and take the hint; ANSI C compilers should react to "..." in the function definition; others may need a "pragma".

This should clarify the value of placing the *double* value into the integer registers; that way "stdarg" and the compiler can just store the registers *a0- a3* into the first 16 bytes of the argument structure, regardless of the type or number of the arguments.



## Returning value from a function

An integer or pointer return value will be in register *v0* (\$2). Register *v1* (\$3) is reserved by the MIPS ABI but many compilers don't use it. However, expect it to be used for returning 64-bit integer values in certain compilers (probably as a *long long* data type).

Any floating point result comes back in register *\$f0* (implicitly using *\$f1* if the value is double precision).

If a function is declared in C as returning a structure value, that value is not returned in registers. Instead an additional implicit argument, a pointer to a caller-supplied structure template, is prepended to the explicit arguments; and the called function copies its return value to the template. Following the normal rules for arguments the "implicit" first argument will be in register *a0* when the function is called. On return *v0* points to the returned structure, too.

## Macros for prologues and epilogues

Most assemblers seem to provide a partial prologue macro, which at least hides the pseudo-ops required to define a function and to record, in the object file, information for debuggers to use when conversing about your function.

## Stack-frame allocation

Provided that a function (written in any language) adheres to the calling conventions, it can do anything it likes with the stack. There are some additional conventions which, if adhered to, can ease the task of a debugger while doing a stack backtrace. These conventions are not described here; use of the recommended function prologue and epilogue macros enables code to support them.

Functions can be divided into three classes; three different approaches satisfy most programming needs.

### Leaf functions

Functions which contain no calls to other functions are called *leaf* functions. Because of this they don't have to worry about setting up argument structures and can safely maintain data in the non-preserved registers *t0* - *t7*, *a0* - *a3* and *v0* - *v1*, and may use the stack for storage if required. They can leave the return address in register *ra* and return directly to it.

Most functions written in assembler for tuning reasons, or as convenience functions for accessing features not visible in C, will be leaf functions. The declaration of such a function is very simple, e.g.:

```
#include <idtc/asm.h>
#include <idtc/regdef.h>

LEAF(myleaf)
    ...
    <system specific code goes here>
    ...
    j    ra
END(myleaf)
```

Most toolchains can pass assembler source code through the C macro pre-processor before assembling it. The files *<idtc/asm.h>* and *<idtc/regdef.h>* include useful macros (like `LEAF` and `END`, above) for declaring global functions and data; they also allow the use of software register names, e.g. *a0* instead of *\$4*. If using the MIPS Corp. toolchain, for example, the above fragment would be expanded to:

```
.globl myleaf
.ent    myleaf,0
...
<system specific code goes here>
```

```

...
j      $31
.end   myleaf

```

Other toolchains may have different definitions for these macros, as appropriate to their needs.

### Non-leaf functions

Non-leaf functions are those which contain calls to other functions. Normally the function starts with code (the “function prologue”) to reset *sp* to the low-water mark of argument structures for any functions which may be called, and to save the incoming values of any of the registers *s0* – *s8* which the function uses. Stack locations must also be reserved for *ra*, automatic (i.e. stack-based local) variables, and any further registers whose value this function needs preserved over its own calls (if the values of the argument registers *a0* – *a3* need to be preserved, they can be saved into their standard positions on the “argument structure”).

Note that, since *sp* is set only once (in the function prologue) all stack-held locations can be referenced by fixed offsets from *sp*.

This is illustrated in the non-leaf function listed below, in conjunction with the picture of the stackframe in Figure 10.1, “Stackframe for a non-leaf function”.

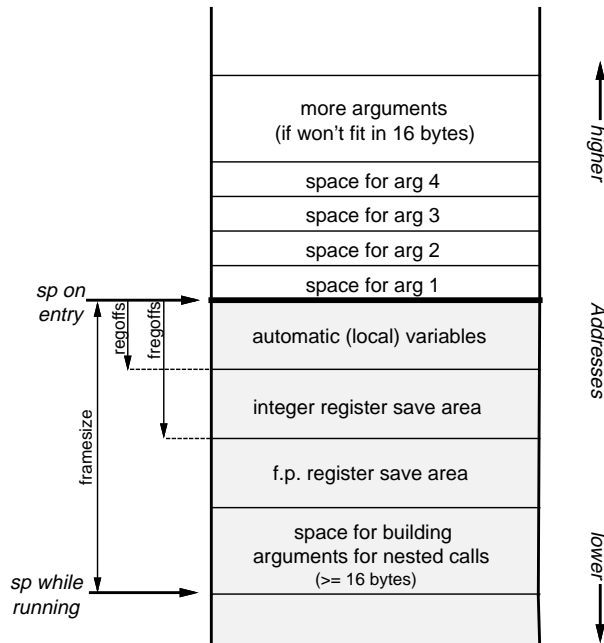

**Figure 10.1. Stackframe for a non-leaf function**

```

#include <idtc/asm.h>
#include <idtc/regdef.h>

#
# myfunc (arg1, arg2, arg3, arg4, arg5)
#

# framesize = locals + regsave (ra,s0) + pad + fregsave (f20/21)
+ args + pad
myfunc_frmsz= 4 + 8 + 4 + 8 + (5 * 4) + 4

NESTED(myfunc, myfunc_frmsz, zero)
subu sp,myfunc_frmsz
.mask 0x80010000, -4

```

```

sw ra,myfunc_frmsz-8(sp)
sw s0,myfunc_frmsz-12(sp)
.fmask 0x00300000, -16
s.d $f20,myfunc_frmsz-24(sp)
...
<your code goes here, e.g>
# local = otherfunc (arg5, arg2, arg3, arg4, arg1)
sw a0,16(sp) # arg5 (out) = arg1 (in)
lw a0,myfunc_frmsz+16(sp)# arg1 (out) = arg5 (in)
jal otherfunc
sw v0,myfunc_frmsz-4(sp)# local = result
...
l.d $f20,myfunc_frmsz-24(sp)
lw s0,myfunc_frmsz-12(sp)
lw ra,myfunc_frmsz-8(sp)
addu sp,myfunc_frmsz
jr ra
END(myfunc)

```

Analyzing the above example, one step at a time:

```

#
# myfunc (arg1, arg2, arg3, arg4, arg5)
#

```

The function `myfunc` expects five arguments: on entry the first four of these will be in registers `a0` – `a3`, and the fifth will be at `sp+16`.

```

# framesize = locals + regsave (ra,s0) + pad + fregsave (f20/21)
+ args + pad
myfunc_frmsz= 4 + 8 + 4 + 8 + 20 + 4

```

The total frame size is calculated as follows:

- *locals (4 bytes)*: keep one local variable on the stack, rather than in a register; the example may need to pass the address of the variable to another function.
- *regsave (8 bytes)*: save the return address register `ra`, because this function calls another function; this function also plans to use the *callee-saved* register `s0`.
- *pad (4 bytes)*: the rules say that double precision floating-point must be 8-byte aligned, so add one word of padding to align the stack.
- *fregsave (8 bytes)*: the function plans to use `$f20`, which is one of the *callee-saved* floating-point registers.
- *argsize (20 bytes)*: this function is going to call another function which needs five argument words; this size must never be less than 16 bytes if a nested function is called, even if it takes no arguments.
- *pad (4 bytes)*: the rules say that the stack pointer must always be 8-byte aligned, so add another word of padding to align it.

```

NESTED(myfunc, myfunc_frmsz, zero)
subu sp,myfunc_frmsz

```

In the MIPS Corp. toolchain this would be expanded to:

```

.globl myfunc
.ent myfunc,0
.frame $29,myfunc_frmsz,$0
subu $29,myfunc_frmsz

```

This declares the start of the function, and makes it globally accessible. The **.frame** function tells the debugger the size of stack frame to be created, and finally the **subu** instruction creates the stack frame itself.

```
.mask 0x80010000, -4
sw ra,myfunc_frmsz-8(sp)
sw s0,myfunc_frmsz-12(sp)
```

The function must save the return address and any *callee-saved* integer registers used, in the stack frame. The **.mask** directive tells the debugger which registers will be saved ( $\$31$  and  $\$20$ ), and the offset from the top of the stack frame to the top of the save area: this corresponds to *regoffs*. The **sw** instructions then save the registers: the higher the register number, the higher up the stack it is placed (i.e. the registers are saved in order).

```
.fmask 0x00300000, -16
s.d $f20,myfunc_frmsz-24(sp)
```

The code then does the same thing for the *callee-saved* floating-point registers  $\$f20$  and (implicitly)  $\$f21$ . The **.fmask** offset corresponds to *fregoffs*, i.e. local variable area + integer register save area + padding word.

```
# local = otherfunc (arg5, arg2, arg3, arg4, arg1)
sw a0,16(sp) # arg5 (out) = arg1 (in)
lw a0,myfunc_frmsz+16(sp)# arg1 (out) = arg5 (in)
jal otherfunc
```

This program calls the function `otherfunc`. Its arguments 2 to 4 are the same as this programs' arguments 2 to 4, so these can pass straight through without being moved. However, the code must swap argument 5 and argument 1, so it copies:

- its input `arg1` (in register `a0`) to the `arg5` position in the outgoing argument build area (new `sp + 16`).
- its input `arg5` (at old `sp + 16`) to outgoing argument 1 (register `a0`).

```
sw v0,myfunc_frmsz-4(sp)# local = result
```

The return value from `otherfunc` is stored in the local (automatic) variable, allocated the top 4 bytes of the stack frame.

```
l.d $f20,myfunc_frmsz-24(sp)
lw s0,myfunc_frmsz-12(sp)
lw ra,myfunc_frmsz-8(sp)
addu sp,myfunc_frmsz
jr ra
END(myfunc)
```

Finally the function epilogue reverses the prologue operations: restores the floating-point, integer and return address registers; pops the stack frame; and returns.

### Functions needing run-time computed stack locations

In some languages dynamic variables can be created whose size varies at run-time. Some C compilers support this, by using the useful library function `alloca`. This means that `sp` has been lowered by an amount unknown at compile time, so the compiler can't use it to reach stack locations.

In this case the function prologue grabs another register, `s8`, also known as `fp`, and points it to the post-prologue value of `sp`.

Since `fp` is one of the saved registers, the prologue must also save its old value. In the function body, all stack location references to automatic variables, and saved-register positions are made via `fp`. But when calling other functions, and putting data into the argument structure, that will be done with relation to `sp`.

Assembler buffs may enjoy the observation that, when creating space with *alloca* the address returned is actually a bit higher than *sp*, since the compiler has still reserved space for the largest argument structure required by any function call.

This example is a slightly modified version of the function used in the last section, with the addition of a “call” to *alloca*.

```
#include <idtc/asm.h>
#include <idtc/regdef.h>

#
# myfunc (arg1, arg2, arg3, arg4, arg5)
#

# framesize = locals + regsave (ra,s8,s0) + fregsave (f20/21) +
args + pad
myfunc_frmsz= 4 + 12 + 8 + (5 * 4) + 4

    .globl myfunc
    .ent  myfunc,0
    .frame fp,myfunc_frmsz,$0

    subu  sp,myfunc_frmsz
    .mask 0xc0010000, -4
    sw   ra,myfunc_frmsz-8(sp)
    sw   fp,myfunc_frmsz-12(sp)
    sw   s0,myfunc_frmsz-16(sp)
    .fmask 0x00300000, -16
    s.d  $f20,myfunc_frmsz-24(sp)
    move fp,sp # save bottom of fixed
frame
    ...
    # t6 = alloca (t5)
    addu t5,7 # make sure that size
    and  t5,~7 # is multiple of 8
    subu sp,t5 # allocate stack
    addu t6,sp,20 # leave room for args
    ...
    <your code goes here, e.g>
    # local = otherfunc (arg5, arg2, arg3, arg4, arg1)
    sw   a0,16(sp) # arg5 (out) = arg1 (in)
    lw   a0,myfunc_frmsz+16(fp)# arg1 (out) = arg5 (in)
    jal  otherfunc
    sw   v0,myfunc_frmsz-4(fp)# local = result
    ...
    move sp,fp # restore stack
pointer
    l.d  $f20,myfunc_frmsz-24(sp)
    lw   s0,myfunc_frmsz-16(sp)
    lw   fp,myfunc_frmsz-12(sp)
    lw   ra,myfunc_frmsz-8(sp)
    addu sp,myfunc_frmsz
    jr   ra
END(myfunc)
```

There are a few notable differences from the previous example:

```
.globl myfunc
.ent  myfunc,0
.frame fp,myfunc_frmsz,$0
```

The function can't use the `NESTED` macro any more, since it is using a separate frame pointer which must be explicitly declared using the `.frame` directive.

```
.mask 0xc0010000, -4
sw   ra,myfunc_frmsz-8(sp)
```

```
sw fp,myfunc_frmsz-12(sp)
sw s0,myfunc_frmsz-16(sp)
```

Since the program will modify *fp* (= *s8* = \$30), it must save it in the stackframe too.

```
# t6 = alloca (t5)
addu t5,7           # make sure that size
and t5,~7          # is multiple of 8
subu sp,t5         # allocate stack
addu t6,sp,20      # leave room for args
```

This sequence allocates a variable number of bytes on the stack, and sets a register (*t6*) to point to it. The program must make sure that the size is rounded up to a multiple of 8, so that the stack stays correctly aligned. In addition, it must add 20 to the stack pointer, to leave room for the five argument words that will be used in future calls.

```
sw a0,16(sp)        # arg5 (out) = arg1 (in)
lw a0,myfunc_frmsz+16(fp)# arg1 (out) = arg5 (in)
jal otherfunc
sw v0,myfunc_frmsz-4(fp)# local = result
```

When building another function's arguments, use the *sp* register; but when accessing input arguments or local variables the program must use the *fp* register.

```
move sp,fp         # restore stack
pointer
l.d $f20,myfunc_frmsz-24(sp)
lw s0,myfunc_frmsz-16(sp)
lw fp,myfunc_frmsz-12(sp)
```

Finally, at the start of the function epilogue, restore the stack pointer to its post-prologue position, and then restore the registers (not forgetting to restore the old value of *fp*, of course).

## SHARED AND NON-SHARED LIBRARIES

A C object library is a collection of pre-compiled modules, which are automatically linked into a program's binary when it refers to a function or variable whose name is defined in the module. Many standard C functions like `printf` are defined in libraries.

Libraries provide a simple and powerful way of extending the language; but in a multi-tasking OS every program will carry its own copy of the library function. Modern library functions may be huge; for example the graphics interface libraries to the widely-used X window system add about 300Kbytes to the size of a MIPS object, dwarfing the application code of many simpler programs.

In response to this problem most modern OS' provide some way in which library code may be shared between different applications. There are different approaches:

### Sharing code in single-address space systems

In a single address-space OS like VxWorks<sup>†</sup>, programs can be linked to library functions by deferring the link operation (which actually fixes up the program code) until the program is loaded into system memory. In this kind of system the library function becomes part of a single large program. But:

- The libraries must be written to be "re-entrant"; they may be used by different tasks, and one task may be suspended in the middle of a library function and that function re-used by another.

<sup>†</sup> VxWorks is a trademark of Wind River Systems, Inc.

For simple operations, re-entrancy is easily achieved by avoiding any use of static modifiable data (so that all computation is done on the stack and in machine registers). However, where library functions must maintain internal data life gets much more complicated; accesses to shared variables must use the programming technique of critical regions protected by semaphores.

This does mean that library programmers must respect these rules, and can't just recompile existing code into libraries without modification.

- The run-time system must maintain a symbol table for loading. System utilities such as the debugger also need access to the symbol table and relocation information.

In such a system a little extra work at load time allows a single copy of a library function to be freely used by the OS kernel, drivers and any number of application tasks. Simple functions suffer very little run-time overhead (the convenient gp-relative addressing optimization, described in the last chapter, cannot be used); the critical region overhead for shared data is unavoidable.

### Sharing code across address spaces

In a "protected" OS where separate applications run in separate virtual address spaces, the problems are quite different. This section will outline the way in which Unix-like systems conforming to the MIPS/ABI standard provide libraries which can be shared between different applications, with no restriction on how the libraries and applications can be programmed.

Every MIPS/ABI application runs in its own virtual address space. The application code is fixed to particular locations in this address space when it is linked. Library code is not built in; the application carries a table of the names of library functions and variables which are used, but not yet included. In addition, the application's symbol table defines public items which may be called from the library; under MIPS/ABI, library routines may freely refer to public data, or call public functions, in application code†.

In the MIPS/ABI model the binary application code must not be modified; it may itself be shared by multiple invocations of the application by multiple users.

It is not possible to predefine the actual virtual addresses at which a library's code and data will be located, but the offset from the start of its code to the start of its data is fixed, and this permits a number of tricks to be used.

- *Position-independent code*: the compiler and assembler (by a command line option, used for library functions) can generate fully "position independent code" (PIC). All MIPS branch instructions are PC-relative; somewhat more complex sequences must be used to load a PC-relative address into a register, but if necessary it can be done:

```
la rd, label ->    bgezal $zero, 1f
                   nop
                   1:    addu rd, $31, label - 1b
```

- *Indirection and the Global offset table*: PIC is suitable for references to code within a single module of a library (because the module's code is loaded as a single entity into consecutive virtual addresses). Data, or external functions, will be at locations which cannot be determined until the application and library are loaded, and so their addresses cannot be embedded in the program text.

---

† Though this may not be good programming practice.

Such addresses are held in a table built in the each library's per-process data space, the "global offset table" (GOT). Since the data space is not shared and is writable, the table can be built as the application and its libraries are loaded.

A library function refers to a variable or external function through the GOT at a table index fixed when the library was compiled and linked. A load of the external integer type "errno" will come out as:

```
lw rd, errno →    la gp, ThisLibsGOTBase
                  lw rd, errno_offset(gp)
                  nop
                  lw rd, 0(rd)
```

Similarly, invocation of the shared-library function `exit()` would look like this:

```
/* setup argument */
jal exit →        la gp, ThisLibsGOTBase
                  lw t9, exit_offset(gp)
                  nop
                  jalr t9
```

The register `gp` (or `$28`) is a good choice for the table base. Because of its role in providing fast access to short variables it is not modified by standard functions. As an optimization it is calculated only once per function, in the function prologue. The calculation uses the fact that the function's actual virtual address will be in `t9` (see previous example), and that the library's GOT is at a fixed offset from its code. So a position-independent function prologue might start like this:

```
func:
    la    gp, _gp_disp
    addu  gp, gp, t9
    addu  sp, sp, framesize
    sw    gp, 32(sp)
```

In the above example, `_gp_disp` is a magic symbol which is recognized by the linker when building a shared library: its value will be the offset between the instruction and the GOT. The calculated value is saved on the stack, and must be restored from there after a call to an external function, since that function may itself have modified `gp`.

There is much more that could be said about the way in which the MIPS/ABI implementation is optimized. For example, no attempt is made to link in libraries when an application is first loaded into memory; dummy GOT entries are used instead. When and if the application uses a library module, the reference is caught and fixed up in much the same way as a virtual-memory system incrementally pages-in a program image.

## AN INTRODUCTION TO OPTIMIZATION

The compiler writer's first responsibility is to ensure that the generated code does precisely what the language semantics say it should; and that is hard enough. In modern compilers, the optimizer has a secondary purpose, which is to allow the compiler's basic code generator to be simple (and therefore easier to implement correctly).

### Common optimizations

Most compilers will do all of the following. Occasionally the assembler may get in on some of them too.



- *Common sub-expression elimination (CSE)*: this detects when the code is doing the same work twice. At first sight this looks like it is just making up for dumb programming; but in fact CSE is critically important, and tends to be run many times to tidy up after other stages:

- a) It is CSE which gives the compiler the ability to optimize across the function. The basic code generator works through the program expression-by-expression; even for well-written source-code, the expansion of simple C statements into multiple MIPS instructions will lead to a lot of duplicated effort. The very first CSE pass factors out the duplication and clears the way for register allocation.
- b) Most memory-reference optimization is actually done by CSE – the code which fetches a variable from memory is itself a sub-expression.

The enemy of CSE is unpredictable flow of control: the conditional branch. Once code turns into spaghetti, the compiler finds it difficult to know what computation has run before which; with some straightforward exceptions, CSE can really only operate inside *basic blocks* (a piece of code delimited by, but not containing, either an entry point or a conditional branch). CSE markedly improves both code density and run-time performance.

Similar to CSE are the optimizations of constant folding, constant propagation and arithmetic simplification. These pre-compute arithmetic performed on constants, and modify other expressions using standard algebraic rules so as to permit further constant folding and better CSE.

- *Jump optimization*: removes redundant tests and jumps. Code produced by earlier compiler stages often contains jumps to jumps, jumps around unreachable code, redundant conditional jumps, and so on. These optimizations will remove this redundancy.
- *Strength reduction*: means the replacement of computationally expensive operations by cheaper ones. For example; multiplication by a constant value can be replaced by a series of shifts and adds. This actually tends to increase the code size while reducing run-time.
- *Loop optimization*: studies loops in the code, starting with the inner ones (which, the compiler guesses, will be where most time is spent). There are a number of useful things which can be done:
  - a) Sub-expressions which depend on variables which don't change inside the loop can be pre-computed before the loop starts.
  - b) Expressions which depend in some simple way on a loop variable can be simplified. For example, in:

```
int i, x[NX];

for (i = 0; i <NX; i++)
    x[i]++;
```

the array index (which would normally involve a multiplication and addition) can be replaced by an incrementing pointer.

This kind of optimization will usually recognize only a particular set of stylized opportunities.

- c) Loops can be “unrolled”, allowing the work of 2 to a few iterations of the loop to be performed in line. On some processors where branches are inherently slow, this is inherently effective; but this isn't true for the R30xx family.

But the unrolled loop offers much better opportunity for other optimizations (CSE and register allocation being the main beneficiaries).

Loop unrolling may significantly increase the size of the compiled program, and usually must be requested as a specific compiler option.

- *Function inlining*: the compiler may guess that some small functions can be expanded in-line, like a macro, rather than calling them. This is another optimization which increases the size of the program to give better performance, and usually requires an explicit compiler option. Some compilers may recognize the `inline` keyword used in C++ to allow the programmer to specify which functions should be “inlined”.
- *Minimize Register allocation*: by far the most important optimization stage is to make the best possible use of the 32 general purpose registers, to make code faster and smaller. The compiler identifies global variables (static and external data stored in memory); automatic variables (defined within a function, and notionally stored on the stack); and intermediate products of expression evaluation.

Any variable must eventually be assigned to a machine register, and input data copied to that register, before the CPU can do anything useful with it. The register allocator’s job is to minimize the amount of work done in shuffling data in and out of registers; it does this by maintaining some variables in registers for all or part of a function’s run-time.

Note:

- a) This process usually entirely ignores the old-fashioned “C” `register` attribute. It might be used as a hint; but most compilers figure out for themselves which variables are best kept in registers, and when.
- b) The MIPS convention provides the compiler with 9 registers `s0-s8` which can be freely used as automatic variables. Any function using one of these must save its value on entry, and restore it on exit. These registers tend to be suitable for long-term storage of user variables.

It also has a set of 10 “temporary” registers `t0-t9` which are typically used for intermediate values in expression evaluation. The “argument” registers `a0-a3` and “result” registers `v0-v1` can be freely used too. However, these values don’t survive a function call; if data is to be kept past a function call it is more efficient to use one of the “callee saved” registers `s0-s8`, because then the work of saving and restoring the value will be done only if a called function really wants to use that register.

- c) C’s semantics mean that any write through a pointer could potentially alter almost any memory location; so a compiler’s ability to maintain a user-defined variable in a register is strictly limited. It is safe to do so for any function variable (automatic variable) which is nowhere subject to the “address-of” operator “&”. It may be able to do this for a variable inside a loop where there is neither a store-through-pointer operation nor a function call.
- *Pipeline-specific code re-scheduling*: the compiler or assembler can sometimes move the logical instruction flow around so as to make good use of the branch and load “delay slots”. In practice, the delay slots are fine grain and tied to specific machine instructions; and this can only be done late in the compilation process.

The most obvious techniques are:

- a) If the instruction succeeding a load doesn’t depend on the loaded value, just leave out the `nop` which would have been placed in the delay slot.

- b) Move the logically-preceding instruction into the delay slot. The optimizer may be able to find an instruction a few positions preceding the branch or load, provided there are no intervening entry points.

The register-register architecture makes it fairly simple to pick out instructions which depend on each other and cannot be re-sequenced.

- c) For a load, the optimizer may be able to find an instruction in the code after the load which is independent of the load value and is able to be moved into the delay slot.
- d) Moving the instruction just before a branch into the branch delay slot.
- e) Duplicating the instruction at a branch target into the branch delay slot, and fixing up the branch to go one more instruction forward.

This is particularly effective with loop-closing instructions. If the branch is conditional, though, the compiler can only do it if the inserted instruction can be seen to be harmless when the branch is not taken.

### How to prevent unwanted effects from optimization

Some code may rely on system effects invisible to the compiler. Examples include software intended to poll the status register of a serial port and send a character when it's ready:

```
unsigned char *usart_sr = (unsigned char *) 0xBFF00000;
unsigned char *usart_data = (unsigned char *) 0xBFF20000;
#define TX_RDY 0x40

void putc (ch)
char ch;
{
    while ((*usart_sr & TX_RDY) == 0)
        ;

    *usart_data = ch;
}
```

A compiler, left to optimize this as for any other program, may send 2 characters and then enter an infinite loop. The compiler sees the memory reference implied by `*usart_sr` as a loop-invariant fetch; there are no stores in the "while" loop so this seems a safe optimization. The compiler has actually coded for:

```
void putc (ch)
char ch;
{
    tmp = (*usart_sr & TX_RDY);

    while (tmp)
        ;

    *usart_data = ch;
}
```

With most compilers, this particular problem is prevented by defining registers carefully:

```
volatile unsigned char
    *usart_sr = (unsigned char *) 0xBFF00000;
volatile unsigned char
    *usart_data = (unsigned char *) 0xBFF20000;
```

A similar situation can exist if software must examine a variable that is modified by an interrupt or other exception handler. Again, declaring the variable as “volatile” should fix the problem.

Although the C rules describe the operation of “volatile” as implementation dependent, most compilers which ignore the “volatile” keyword are expected to play safe.

There are other, more subtle, ways in which optimizations can break a program. For example, it may change the order in which some loads and stores occur. It may be easier to write and maintain hardware driver code in C than in assembler, but it’s the programmer’s responsibility to know exactly what the compiler did, and to make sure it’s what was wanted.

### **Optimizer-unfriendly code and how to avoid it**

Certain kinds of C programs will cause problems for a MIPS CPU and its optimizing compiler, and will cause unnecessary loss of performance. Some things to avoid are:

- *Sub-word arithmetic* : use of `short` or `char` variables in arithmetic operations is less efficient than using full word arithmetic. The MIPS CPU lacks sub-word arithmetic functions and will have to do extra work to make sure that expressions overflow and wrap around when they should. The `int` data type represents the optimum arithmetic type for the R30xx family; most of the time `short` and `char` values can be correctly manipulated by `int` automatic variables.
- *Taking the address of a local variable*: the compiler will now have to consider the possibility that any function call or write through a pointer might have changed the variable’s value; so it won’t live long in a machine register.

Perhaps the best way of seeing this is that defining a variable local to a function (and whose address is not taken) is essentially free. It will be assigned to a register, which would have been needed in any case for the intermediate result.

- *Nested Function calls*: in the MIPS architecture the direct overhead of a function call is very small (2-3 clocks). But the function call makes it difficult for the compiler to make good use of registers, so may be much more costly in terms of lost optimization opportunity. Inside a function with a fairly complex set of local variables a nested call could be as slow as a typical CISC function call, and add a lot of code.

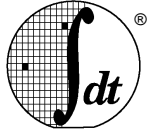

Integrated Device Technology, Inc.

## PORTABILITY CONSIDERATIONS

## CHAPTER 11

This chapter discusses three distinct facets of portability to be concerned about:

- Migrating existing software from another CPU architecture to the R30xx family.
- Writing code that can readily be used on multiple R30xx family members.
- Writing code that will be easily portable to future family members.

Techniques such as modular programming can be used to facilitate virtually all of these areas, but are beyond the scope of this manual. Instead, this manual will focus in on the architecture-specific portability issues.

Since most modern embedded programming uses the “C” programming language, this chapter will begin with a review of the portability concerns associated with this programming language.

Additionally, this chapter will review some of the historical obstacles to program portability: byte ordering conventions, word sizes, alignment constraints, and so on; and will discuss the manner in which the MIPS architecture deals with these issues. This review is intended to discuss the issues which complicate porting existing code, developed for execution on other architectures, to the R30xx family.

Finally, this chapter will discuss generating an environment to support multiple family members, both existing and possible future members, to enable the investment in porting to be applied to a wide variety of system cost-performance points.

### WRITING PORTABLE C

“C” is one of a class of languages which originally aimed to abstract the abilities of a class of simple minicomputers, to add some terse and powerful syntax for flow of control, and to provide simple but adequate mechanisms for data structuring.

A language standard such as Pascal or Ada sets out to make portability compulsory; the language attempts to make it impossible for program behavior to be dependent on what kind of CPU is being used. C lets the underlying implementation show through; it is possible to write portable C by programming discipline, but it doesn’t happen automatically.

C’s low-level origins contribute to its power and efficiency, but make it inherently prone to non-portability. Good examples are the following:

- *Basic data types*: change in their size (i.e. the number of bits of precision) between different implementations.
- *Pointers*: (inevitably implemented as real machine pointers) expose the memory layout of data, which is implementation-dependent.

Some things have got easier with time; early C implementations had to target machines with 7-, 8- and 9-bit *char* types, and with 36-bit machine words. It is now entirely reasonable to assume that targets will have an 8-bit *char* which is the smallest addressable unit of memory, and other basic types will be 16-, 32- or 64-bits in size.

### C Language Standards

C has evolved continuously since its early days. It has definitely gone up-level; most changes have tended to increase the amount of abstraction and checking. To date, there are three main “variants”, or standards, for the C language.

- *K&R*: named after the C Programming Manual by Kernighan and Richie, this reflects the standard used for the first few years of Unix life. It has little type-checking, many defaults, and the compilers rarely complain. However, it provides a useful *lingua franca*: most compilers will (sometimes unwillingly and with warnings) correctly translate programs written to K&R.

In practice the language was, during this period, defined by a single implementation: AT&T Bell Lab's Portable C compiler.

- *ANSI*: the ANSI standard collects together "improvements" made over the years and regulates them. ANSI defines syntax allowing the programmer to make far more well-defined declarations of functions, and then checks programmer usage against them. ANSI compilers tend to produce more warning messages than K&R compilers, reflecting the greater amounts of type-checking performed.

A number of compilers use "compliance test suites" to "guarantee" ANSI compliance. A common test suite is the "Plum-Hall" test suite, which includes modules to test a compiler (and its libraries) compliance to the ANSI rules. The IDT/C compiler uses this compliance suite to validate its ANSI compliance.

- *GNU*: the Free Software Foundation's GNU compiler is set to restore the dominance of a single implementation of the compiler, and thus permit the emergence of a new dialect†. Note that the GNU compiler does support ANSI compliance; it is just that, as an "experimental" toolchain, it may also support more "cutting edge" extensions to ANSI than are currently supported by the standards body.

GNU also adds a number of very valuable features; including function inlining, a robust "asm" statement, *alloca()*.

GNU provides the benefit of being available across multiple hosts and target architectures. Thus, porting applications developed using the GNU toolchain from some other architecture to the R30xx will avoid the porting problems associated with compiler PRAGMAs, compiler directives, and the like.

Similarly, porting ANSI compliant code from a different architecture should be relatively straight-forward. However, differences in supported PRAGMAs, and other environmental differences, may cause a higher level of porting activity.

### **C Library Functions and POSIX**

C supports separate compilation of modules, allowing the resulting object code files to be linked together without recourse to the source. C libraries are bunches of pre-compiled object code defining common functions. The "standard" C library of everyday functions is to all intents and purposes part of the language.

The ANSI standard addresses a subset of common library functions and lays down their function. But this deliberately steers clear of "OS-dependent" functions; and these include the simplest input/output routines.

The POSIX (IEEE1003.4) standard is probably the best candidate, defining a standard C language interface to a workable IO system. POSIX has its problems:

- it does not yet cover all OS features (and probably shouldn't);

---

† GNU C is also an extraordinary experiment; a major piece of ingenuity and intellectual work being maintained and continually developed by a large, loose-knit, worldwide community of workers, many of them volunteers. No other piece of free software has filtered quite so far into the body of the computer industry.

- its definers occasionally felt obliged to standardize an “improvement” of current practice, so POSIX compliance is still hard to find even in big OS'es.

But it is a huge improvement on earlier single-camp standards and will undoubtedly become important. Programs adhering to POSIX should be able to be rebuilt on a large range of OS, including Desktop OS'es (such as UNIX) and RTOS environments. Using POSIX compliant library functions will further enhance portability across toolchains and architectures.

## DATA REPRESENTATIONS AND ALIGNMENT

The MIPS architecture can only load multi-byte data which is “naturally” aligned – a 4-byte quantity only from a 4-byte boundary, etc. Many CISC architectures don't have this restriction (although many RISC architectures do follow this restriction, and in fact may offer less support than the MIPS machine code does for this situation). The compiler is designed to ensure that data lands up in the right place; and this requires far-reaching (and not always obvious) behaviors. These include:

- Padding between fields of data structures.
- Defensive alignment; base addresses of structures, or stack frames, are aligned to the largest unit to which the architecture is sensitive (4 or 8 bytes in the MIPS architecture).

The toolchain used for previous development, targeted to a different CPU architecture, may do this differently.

Consider the following examples:

```
struct foo {
    char small;
    short medium;
    char again;
    int big;
}
```

This will be laid out in memory as shown in Figure 11.1, “Structure layout and padding in memory”:

offset (bytes)	0	1	2	3	4	5	7	8	11
	small	×	medium	again	×	big			

**Figure 11.1. Structure layout and padding in memory**

## Notes on structure layout and padding

These notes should be taken as typical of what a good compiler will do. They are required by, for example, a MIPS/ABI compliant compiler; but beware – a compiler *could* still be fully compliant with C standards and use wholly counterintuitive data representations – so long as these were internally consistent.

- *Alignment of structure base address*: the data structure itself will always be placed on a 4-byte boundary; a structure's alignment is that of its most demanding subfield. `struct foo` contains an `int` requiring 4-byte alignment, so the structure itself will be 4-byte aligned.

Dynamic memory allocation, either on the stack or by software routines such as `malloc()` could give rise to alignment problems; so they are specified to return pointers aligned to the largest size which the architecture cares about. In the case of the R30xx family this need only be 4 bytes, but in fact is usually 8 bytes: a gesture towards compatibility with future 64-bit implementations.

- *Memory order*: fields within structures are stored into memory in the order declared.

- *Padding*: is generated whenever the next field would otherwise have the “wrong” alignment with respect to the structure’s base address.
- *Endianness*: has no effect on the picture shown by Figure 11.2, “Data representation with #pragma pack(1)”. Endianness determines how an integer value is related to the values of its constituent bytes (when they are considered separately); it does not affect the relative byte locations used for storing those values.

Endianness does have some effect on C bitfields, which are discussed below.

There’s an irrefutable, pure and correct position on data structures and portability; the memory representation of data is compiler dependent, and the programmer should not expect it to be in any way portable – even between two different compilers for the same architecture. In general, it is reasonable to expect to be able to exchange a sequence or consecutive array of *chars* (each taking a value between 0 and 255), but not more. But in the real world it would be inefficient to make sure that all data ever exchanged or published by programs was in the form of byte strings.

ANSI compilers may support an option using the “pack” PRAGMA:

```
#pragma pack(1)
struct foo {
    char small;
    short medium;
    char again;
    int big;
}
```

has the effect of causing the compiler to omit all padding, producing the layout shown in Figure 11.2, “Data representation with #pragma pack(1)”:

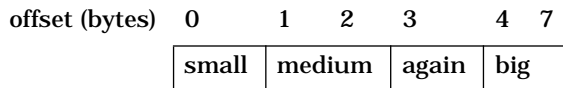

**Figure 11.2. Data representation with #pragma pack(1)**

A structure packed like this has no inherent alignment, so in addition to the lack of any padding, the structure base address may also be unaligned. The compiler will always generate load and store sequences to its fields which are alignment independent (and therefore to some extent inefficient) – even though, in this particular case, the *big* field happens to have the correct 4-byte alignment from the structure base.

Structure packing is most frequently used when storing large files of a particular structure in memory; for example, when storing the “description” of a font in the ROMs of a printer. By eliminating padding, more font structures can be saved in a smaller amount of memory; the cost of doing this occurs at run-time, when more conservative code sequences must be used to read fields from the structure.

The “1” in `pack(1)` refers to the maximum alignment which must be respected, so “pack(2)” means align only to 2-byte boundaries:

```
#pragma pack(2)
struct foo {
    char small;
    short medium;
    char again;
    int big;
}
```



The preceding code fragment has the effect of causing the compiler to pad items of 2 bytes or larger to 2-byte boundaries, producing the layout shown in Figure 11.3, “Data representation with #pragma pack(2)”:

offset (bytes)	0	1	2	3	4	5	6	9
	small	×	medium	again	×	big		

**Figure 11.3. Data representation with #pragma pack(2)**

The #pragma pack feature is not the only potential source of data representation incompatibility; endianness, discussed below, can also pose a significant portability issue. Nonetheless, used with care this feature can reduce the amount of difference between sources for two different architectures.

## ISOLATING SYSTEM DEPENDENCIES

It is unlikely that the source code to be ported is literally the complete system. Most programs depend on an environment implemented by underlying independent software (perhaps from a 3rd party); this may be bound in at run time (an operating system or system monitor), or at link time (library functions, “include” files). Quite often, sources may not be available; sometimes they will just be more trouble to port than to reproduce.

This is the point at which the programmer will appreciate the purpose of attempts to standardize a C runtime library. If only the boundary between the “application” program and its environment consisted of well-defined standard calls and include files, the job would be trivial. It isn’t, usually.

### Locating system dependencies

In general, the “core application” consists of the code which does NOT meet the following criteria:

- Supplied as part of an OS the new system won’t be using;
- A library function which is not available (with *exactly* the same semantics) in the target compilation system;
- Not licensed for use on the new target system.

There are two “concentric” boundaries which can be drawn, and in a sense they divide the original code up into three parts:

- The inner part is the application to be ported. The new system may carry this code through unchanged (except where portability problems mean the code needs to be changed); so usually, after porting, this code should still be usable on the original system.
- System dependent code, libraries, OS etc. which are clearly not going to be taken to the new system. Porting should not be an issue for these.
- Glue functions and data which join the two up. These will have to be modified, or sometimes re-implemented, to adapt the application to the new environment.

The glue probably represents 10% of the code; but requires 90% of the work. In a program which has been ported often, the glue will be neatly separated; in a program which evolved in a single system, the glue may be rather deeply mixed with the application.

### Fixing up dependencies

To remove these dependencies, the programmer must first of all, try to find the best boundaries and divide the code into application, glue and environment. Since there will be a new “environment” on the new system, the latter code is more or less irrelevant (and is likely written in assembler, to a great extent).

This is art as well as science; there is no single right way to do it. The objective will be to minimize the scope for introducing new errors, while minimizing the amount of work done.

The “application” part should be recompileable on the new system, generating a list of unresolved definitions which need to be patched up. Some of these, when investigated, will turn out to be used in code which really belonged in the “glue”; move the boundary and iterate until the list of unresolved names makes sense.

The glue now needs to be re-implemented for the new environment. The programmer has two choices for each function:

- Recompile the function, using some “underglue” definitions or functions to mimic the behavior of the old environment using the new one. In a sense, the programmer is pragmatically deciding that what was seen as glue is now application.
- Reimplement the function (using the old one for inspiration and as a source for cut-and-paste), aiming to mimic the function as a “black box”.

For each function or module, choose one of these strategies. It is nearly always a bad idea to mix strategies in the same module.

### **Isolating Non-Portable Code**

In general, it is difficult to write a “stand-alone” program entirely portably. In the desktop environment, programmers write programs to an OS standard; thus, porting a program to a new system is limited to porting that OS. This is the model for UNIX and even for many RTOS-based systems.

As examples, it is easy to write a portable routine to calculate prime numbers; it is much harder to write a portable routine to accept typed input, providing line editing and simple argument parsing (are characters 7- or 8-bit? Is the language English? What accented characters are acceptable? How does the display device implement backspace?)

The best programs hide the nonportable parts of code in modules, whose interfaces consist of stable data declarations and functions whose operation can be expressed succinctly and clearly.

### **Using assembler**

There are three reasons for using assembler:

- *Efficient implementation of critical functions*: getting the last clock cycle out of *strcpy* may well be worthwhile.
- *Access to instructions not supported by the compiler*: e.g. access to control registers. These can sometimes be replaced by using “tiny” subroutines; and sometimes by `Casm` statements. Tiny subroutines are particularly apt when, although the implementation will be completely machine dependent the desired effect is machine-independent – prefer a “disable interrupts” function to a “set status register bits” function.
- *Some critical environmental deficiency*: (most commonly) inability to provide the free use of CPU registers and the stack which the compiler relies on. Classic examples are interrupt handlers. To maximize ease of portability, the programmer can at least make it a priority, in these routines, to build an environment from which software can call C functions.

## ENDIANNESS

The word “endianness” was introduced by a famous short paper† in the Journal of the ACM, in the early 1980’s. The author observed that computer architectures had divided up into two camps, based on an “arbitrary” choice of the way in which byte and word addressing are related. In “Gulliver’s Travels” the little-endians and big-endians fought a war over the correct end at which to start eating a boiled egg; a war notable for the inability of the protagonists to comprehend the arbitrary nature of their difference. The joke was appreciated, and the name has stuck.

The problem comes up in both software and hardware fields – but slightly differently:

- *Endianness – the hardware problem*: this arises when a byte-addressed system is wired up with buses which are multiple-bytes wide. When the system transfers a multi-byte datum across the bus, each byte of that datum has its own, individual address. So:

If the lowest-addressed byte in the datum travels on the 8 bus lines (“byte lane”) with the lowest bit-numbers, the bus is *little-endian*.

If the lowest-addressed byte in the datum travels on the byte lane with the *highest* bit-numbers, the bus is *big-endian*.

Note that there is no longer any dispute in the industry as to how bit numbers relate to arithmetic significance; high bit numbers are always most significant. In particular this means that bits-within-byte have an unambiguous meaning.

All byte addressable CPUs announce themselves as either big- or little-endian every time they transfer data. Intel and DEC CPUs are in general little-endian; Motorola, Sun SPARC and most IBM CPUs are big-endian. MIPS CPUs can be either, as configured from power-up.

For a hardware engineer, endianness only matters when a system includes buses, CPUs or peripherals whose endianness doesn’t match.

The choice facing the hardware engineer is not a happy one; if two components or buses don’t match, the system designer must choose one of two undesirable situations:

- a) If the data buses are connected to preserve byte address, then bit numbering for multi-byte data moving through the system will be inconsistent; so multi-byte data is likely to require re-interpretation by software.
- b) If the data buses are connected with matching bit numbers, then the two sides will see the sequence of bytes in memory differently. This problem can be managed by keeping all data strictly word-aligned, and “byteswapping” before and after transfer.

Where a system includes a MIPS CPU which can be configured with either endianness with no external hardware provided, option (b) is what happens whenever the CPU configuration is changed to mismatch the rest of the system.

- *Endianness – software visibility*: software engineers writing in a high level language apparently have no need to number bits, so might believe themselves immune from this problem. But on closer inspection, it turns out that normal binary numbers (i.e. 2-s complement integers) bigger than 8 bits implicitly define an ordering – some bits are arithmetically more significant.

In software:

---

† “On holy wars and a plea for peace”, Danny Cohen, IEEE Computer, October 1981 pp. 48-54

An architecture where the lowest addressed byte of a multi-byte integer holds the least-significant bits is called little-endian.

An architecture where the lowest addressed byte of a multi-byte integer holds the most significant bits is called big-endian.

Software problems occur on any system afflicted by hardware incompatibility; but the software problem also emerges when a program deals with “foreign” data originating from a system using the opposite convention. The data may arrive on a communications link, on a tape or floppy disk.

- *Why is it so confusing?*: it is difficult even to describe the problem without taking a side. The origin of the two types lies in two different ways of drawing the pictures and describing the data; both natural in different contexts.

Big-endians typically draw their pictures organized around words (32 bits in a MIPS system), like Figure 11.4, “Typical big-endians picture”. What’s more, big-endians see words as a sort of number, so they put the highest bit number (most significant) on the left, like our familiar Arabic numbers. And a big endian sees memory extending up and down the page from the picture in Figure 11.4, “Typical big-endians picture”.

```
union either {
    int as_int;
    short as_short[2];
    char as_char[4];
};
```

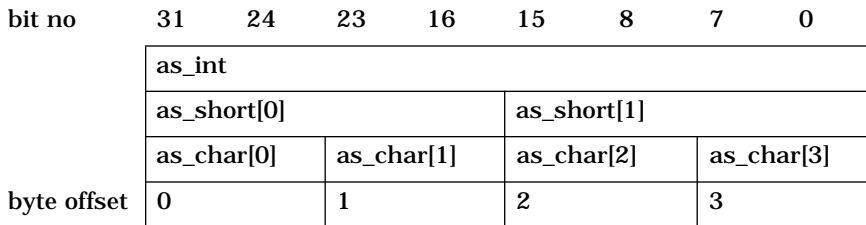

**Figure 11.4. Typical big-endians picture'**

Little-endians are little-endians because they think in bytes, so the same data structure looks like Figure 11.5, “Little endians picture”. Little-endians don’t think of computer data as primarily numeric, so they tend to put all the low numbers (bits, bytes, whatever) on the left. A little endian sees memory extending off to the left and right of the picture...

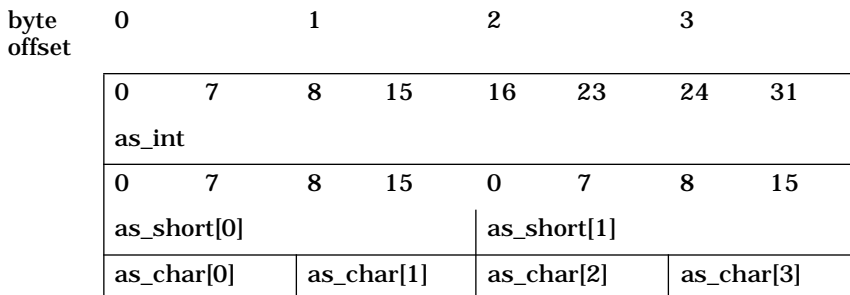

**Figure 11.5. Little endians picture'**

### What it means to the programmer

Software can very easily find out if it is executing as a big-endian, or little-endian, CPU – by a piece of deliberately non-portable code:

```

union either {
    int as_int;
    short as_short[2];
    char as_char[4];
};

either.as_int = 0x12345678;

if (sizeof(int) == 4 && either.as_char[0] == 0x78) {
    printf ("Little endian\n");
}
else if (sizeof(int) == 4 && either.as_char[0] == 0x12) {
    printf ("Big endian\n");
}
else {
    printf ("Probably not MIPS architecture\n");
}

```

In application software, so long as software doesn't carelessly access the same piece of data as two different integer types, endianness should create no problems. But as soon as the program needs to know how data is stored in memory, it is very important.

### Bitfield layout and endianness

C permits programs to define bitfields in structures; as an example, the chapter on floating point used a bitfield structure to map the fields of an IEEE floating point value stored in memory. An FP single value is multi-byte, so this definition is expected to be endianness-dependent. It looked like this:

```

struct ieee754sp_konst {
    unsigned sign:1;
    unsigned bexp:8;
    unsigned mant:23;
};

```

C bitfields are always packed, and the fields are therefore not padded out to yield any particular alignment. But bitfields may not, in fact, span "word" boundaries (usually corresponding to the size of a `long`: 32 bits for the R30xx family). The structure and mapping for a big-endian CPU is shown in Figure 11.6, "Bitfields and big-endian" (using a typical big-endian's picture); for a little-endian version it is shown in Figure 11.7, "Bitfields and little-endian".

bit no	31	30	23	22	0
	sign		bexp		mant
byte offset	0		1		2
					3

**Figure 11.6. Bitfields and big-endian**

The little-endian version of the structure defines the fields in the other direction; the C compiler insists that, even for bitfields, items declared first in the structure occupy lower addresses:

To make that work, as shown in Figure 11.7, "Bitfields and little-endian" that in little-endian mode the compiler packs bits into structures starting from low-numbered bits.

```

struct ieee754sp_konst {
    unsigned mant:23;
    unsigned bexp:8;
    unsigned sign:1;
};

```

byte offset	0	1	2	3
	0		22	0
	mant		bexp	7
				sign

**Figure 11.7. Bitfields and little-endian**

## Changing the endianness of a MIPS CPU

Programming a board which can be configured with either byte ordering is tricky, but possible.

The MIPS CPU doesn't have to do too much to change endianness. The only parts of the instruction set which recognize objects smaller than 32 bits are partial-word loads and stores. The instruction:

```
lbu $t0, 1($zero)
```

takes the byte at byte program address 1, loads it into the least-significant bits (0 through 7) of register *\$t0*, and fills the rest of the register with zero bits.

This *description* is endianness-independent; and the signals produced by the CPU are identical in the two cases – the address will be the appropriate translation of the program address “1”, and the transfer-width code will indicate 1 byte. But: *in big-endian mode the data loaded into the register will be taken from bits 23-16 of the CPU data bus; in little-endian mode the byte is loaded from bits 8-15 of the CPU data bus.*

It is exactly this shift of byte-lane associated with a particular byte address, no more or less, which implements the endianness switch.

The default effect of this switch on a system built for the other endianness is that the CPU's view of byte addressing becomes scrambled with respect to the rest of the system; *but the CPU's view of bit numbering within aligned 32-bit words continues to match the rest of the system.* This is the case described in (b) above; and it has some advantages.

Complementing the chip's ability to reconfigure itself, most MIPS compilers can produce code of either byte-ordering convention.

## Designing and specifying for configurable endianness

Some hard thinking and good advice before the design is committed, may help a great deal. To summarize:

- *Read-only instruction memory*: should be connected to the CPU with bit-number-preserving connections, regardless of configuration. Even if the ROM is less than 32 bits wide, the way in which ROM data is built into words should also be independent of the CPU configuration.
- *IO system or external world connection*: if the system makes any connection to a standard bus, or connects to a memory which gets filled by an agent other than the CPU, or uses a multibyte-wide DMA controller, then it may be appropriate to include a configurable byte-lane swapper between the CPU and IO.
- *Local writable memory*: normally it is best to let this attach in a simple bit-number-preserving way to the CPU bus. If there is a byte-lane swapper in the system, it should also swap lanes between the IO system and the local memory.

### Read-only instruction memory

All MIPS instructions are aligned 32-bit words. If a read-only program memory is attached to the CPU by bit-number-preserving connections which are unaltered between modes, then big-endian and little-endian CPUs run the same instruction set, bit for bit.

The endianness mode shows up only when the CPU attempts a partial-word operation; so a program written without partial-word operations will run the same in either mode. It is reasonably straightforward to build a PROM which could bootstrap the system in either mode.

Algorithmics have used this to build enough “bi-directional” code to at least display an error message when the rest of the PROM program discovers that it mismatches the CPU configuration:

```
.align 4
.ascii "remEcneg\000\000\000y"
```

that’s what the string "Emergency" (with its standard C terminating null and two bytes of essential padding) looks like when viewed with the wrong endianness. It would be even worse if it didn’t start on a 4-byte aligned location. Figure 11.8, “Garbled string storage when mixing modes” (drawn from the bit-orientated point of view of a confirmed big-endian) shows what is going on.

	31	24	23	16	15	8	7	0
	'r'	'e'	'm'	'E'				
byte address from BE CPU	0	1	2	3				
byte address from LE CPU	3	2	1	0				
	'c'	'n'	'e'	'g'				
byte address from BE CPU	4	5	6	7				
byte address from LE CPU	7	6	5	4				
	×	×	'\000'	'y'				
byte address from BE CPU	8	9	10	11				
byte address from LE CPU	11	10	9	8				

**Figure 11.8. Garbled string storage when mixing modes**

### Writable (volatile) memory

The above applies to any program memory; but the system may want to treat volatile program memory differently. Why?

Volatile program memory must be loaded at run-time. Most loading processes ultimately involve fetching instructions from a file, and most files are defined as byte sequences. Thus the 32-bit instruction words must be constructed (one way or the other) from byte sequences. The standard way of storing code in files *does* change between the two options: big-endian code is stored with the most significant byte of each instruction first, and little endian code with the least significant byte first.

### Byte-lane swapping

It may happen that somewhere in the system there is a bus or device whose byte-order doesn’t change when the CPU’s does. The best solution (from a software engineer’s perspective), is to persuade the hardware designer to put a programmable byte-lane swapper between the CPU and the IO system. The way this works is shown diagrammatically in Figure 11.9, “Byte-lane swapper”.

This is referred to as a byte-lane swapper, not a byte-swapper, to emphasize that it does not discriminate on a per-transfer basis, and in particular it is not switched on and off for transfers of different sizes. Such discrimination would be futile; the hardware transfer size does not

consistently reflect the way in which software is interpreting data (for example, cache-line refills may contain byte values). *There is no external hardware mechanism which can hide endianness problems.*

What a byte-lane swapper *does* achieve is to ensure that, when the CPU configuration is changed, the relationship between the CPU and the now non-matching external bus or device is one where byte sequence is preserved.

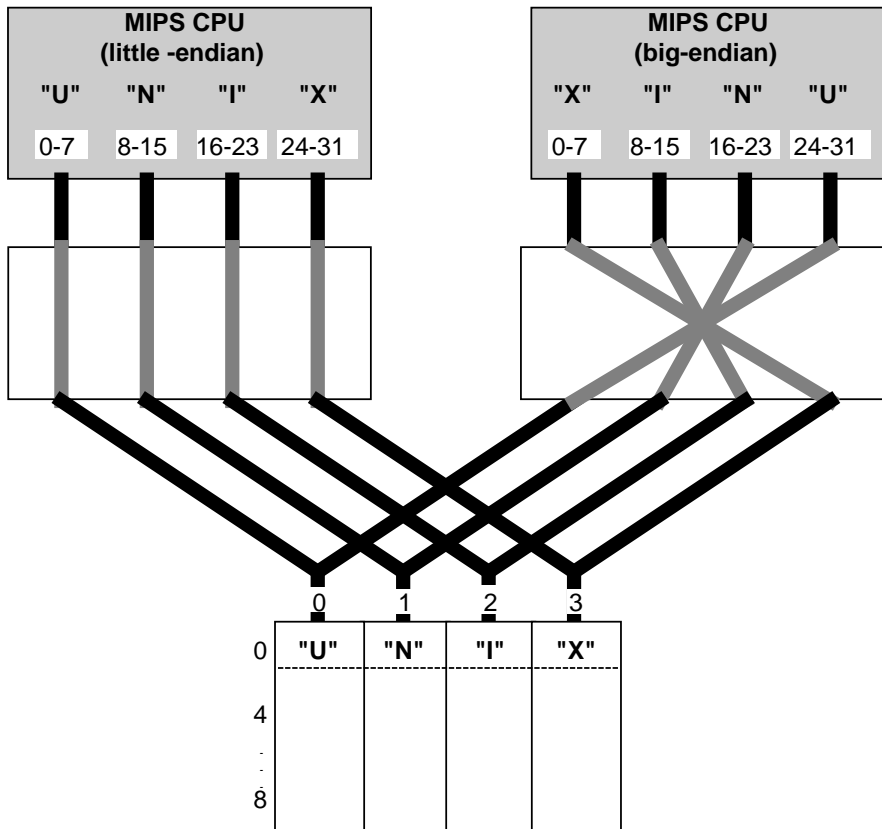

**Figure 11.9. Byte-lane swapper**

When the system includes a byte-lane swapper between the CPU and some memory, it is probably not viable to swap it when using cached memory. It really can be used only:

- a) at system configuration time;
- b) when talking to uncached, IO system locations. The system could discriminate (to swap or not to swap) based on the address regions which select various sub-buses or sub-devices.

The system doesn't normally need to put the byte-lane swapper between the CPU and its local memory; avoiding the use of one in this path is desirable, because the CPU/local memory connection is fast and wide, so the swapper will be expensive. Since the swapper configuration is determined at reset time, and the memory is then completely undefined, the system can treat the CPU/local memory as a unit; the swapper is installed between the CPU/memory unit and the rest of the system. In this case the relationship between bit number and byte order in the local memory changes with the CPU, but this fact is concealed from the rest of the world.

### Configurable IO controllers

Some newer IO controllers can themselves be configured into big-endian and little-endian modes. Use of such devices must be done carefully, particularly when using it not as a static (design-time) option but rather a jumper (reset-time) option.



It is quite common for such a feature to affect only data transfers, leaving the programmer to handle other endianness issues, such as access to bit-coded device registers.

### Portability and endianness-independent code

Any code which exposes data to two different views will be endianness-dependent (and likely to be architecture- and compiler-dependent too). Many MIPS compilers define the symbol “BYTE\_ORDER” so programmers can include endianness dependent code, such as:

```
#if BYTE_ORDER == BIG_ENDIAN
/* big-endian version... /
#else
/* little-endian version... */
#endif
```

With ingenuity and patience the programmer can probably represent the difference with common code but conditional data declarations; that should be more maintainable. However, endianness-independent code should be used wherever possible.

### Endianness-independent code

All data references which pick up data from an “external” source or device are potentially endianness-dependent. But according to how the system is wired, software may be able to work both ways:

- *If the device is byte-sequence compatible:* then it should be programmed strictly with byte operations.

If ever, for reasons of efficiency or necessity, the system must transfer more than one byte at a time, the programmer must figure out how those bytes should pack in to a machine word. This code will be explicitly endianness-dependent, and can be made conditional.

- *If the device is bit-number compatible:* then program it strictly with word (32-bit) operations. This may well mean that device data comes and goes into slightly inconvenient parts of a CPU register; 8-bit registers in system originally conceived as big-endian are commonly wired via bits 31–24. So software may need to shift them up and down appropriately.

## COMPATIBILITY WITHIN THE R30XX FAMILY

It should be relatively straightforward to make R30xx programs compatible across the entire R30xx family. The device user’s manuals detail potential areas of incompatibility, most of which can easily be accommodated by software†. The software-visible differences in these CPUs are as follows:

- *Cache size:* all CPUs have separate I- and D-caches each of between 512 bytes and 16Kbytes. All D-caches are write-through, so the only cache maintenance operation required is that of invalidating an entry. The cache management software uses the same basic code sequences for all family members (which follows the original R3000), using status-register control bits to “isolate” and “swap” the caches.

To maximize portability, system software should measure the cache size at system initialization, as described earlier. Do not rely on the CPU type and revision fields in the ID register.

---

† Perhaps the most notable exception has to do with the TLB. Software environments which utilize kuseg and/or kseg2 will probably not be able to substitute “E” and base-versions for each other.

---

To simplify porting to other MIPS devices, such as the IDT R4600, software should probably structure cache invalidation software as using a single entry point. Thus, when porting to these upscale devices, the amount of software to change is minimized.

- *Cache line size*: All caches are direct mapped. The D-cache always has a line size of one word, and all I-caches have a 4-word line size. The 4-word line size does offer the potential for a faster I-cache invalidation routine; but invalidating each word of a region still works correctly with a 4-word line.
- *Cache-hit write policy*: All of these CPU's will use a read-modify-write sequence when performing a partial-word write to a location already present in the D-cache. This can lead to some curious problems if another memory master is simultaneously accessing the same word; all software should assume that the read-modify-write sequence might occur.
- *Write buffer differences and `wbflush()`*: To make the write-through cache efficient, all R30xx CPUs have a four deep write buffer, which holds the address/data of a write while the CPU runs on. The operation of the write buffer should be invisible when writing and reading regular, side-effect free memory; but it can have effects when accessing IO buffers.

The programmer only needs an implementation of `wbflush()`; a routine defined to hold the CPU in a loop until all pending writes have been completed. In the R30xx family, `wbflush()` can be implemented by performing an uncached read (for example, to the reset exception vector location, since the programmer is assured that the system will provide uncached memory at that location).

In other devices, such as the R4600, a different `wbflush()` may be required. However, by isolating this code into a single routine, porting to the R4600 is simplified.

- *FP hardware*: Currently, only the R3081 integrates the hardware FPA on-chip. For occasional FP instruction trap-based software emulators may be appropriate; the use of the emulator can be completely software-transparent. But for any serious use the emulator will be far too slow.
- *MMU hardware*: If present, it is always the same software-refilled TLB and control set, as described above. Base versions provide consistent mappings for `kuseg` and `kseg2`; however, maximum portability is achieved when programs only use the `kseg0`, `kseg1` regions which are supported by all processors (including the R4600).
- *Integrated IO devices*: Some future CPUs may integrate timers, DRAM controllers, DMA and other memory-mapped peripherals. If the programmer isolates such code into "driver" modules for existing systems, porting to these devices will be simplified.
- *Perform device-type identification at boot-time*: The reset chapter discussed how to identify the particular CPU being used at reset time. Performing device identification allows the software to then branch to the appropriate device specific initialization code (e.g. to initialize the R3041 control registers, or CP1 usability for the R3081). Providing this basic structure as part of reset only enables software to be quickly adapted to support other family members.
- *Isolate CP0 code from applications code*. The MIPS architecture allows CP0 to vary by implementation. By writing the code modularly, so that system and exception management functions are modularized out of the application code, porting to new generations of processors is simplified (e.g. the R4600, which uses a slightly different exception state management mechanism and slightly different vectors, but is otherwise very familiar to an R30xx programmer).

## PORTING TO MIPS: FREQUENTLY ENCOUNTERED ISSUES

The following issues have come up fairly frequently:

- *Moving from 16-bit int*: a significant number of programs are being moved up from x86 or other CPUs whose standard mode is 16-bit, so that the C *int* is a 16-bit value. Such programs may rely, very subtly, on the limited size and overflow characteristics of 16-bit values. While the programmer can get correct operation by translating such types into *short*, this may be very inefficient. Take particular care with signed comparisons.
- *Negative pointers*: when running in unmapped mode on a MIPS CPU all pointers are in the *kseg0* or *kseg1* areas; and both use pointers whose 32-bit value has the top bit set. It is therefore extremely important that any implicit aliasing of integer and pointer types (quite common in C) specify an unsigned integer type (preferably an *unsigned long*).

Unmapped programs on certain other architectures deal with physical addresses, which are invariably a lot smaller than 2GB.

- *Signed vs. unsigned characters*: K&R C made the default *char* type (used for strings, and so on) signed *char*; this is consistent with the convention for larger integer values. However, as soon as programmers have to deal with character encodings using more than 7-bit values, this is dangerous when converting or comparing. So the ANSI standard determines that *char* declarations should, by default, be *unsigned char*.

If the old program may depend on the default sign-extension of *char* types, there is often a compiler option to restore the traditional convention.

- *Data alignment and memory layout*: if a program makes assumptions about memory layout (such as using C *struct* declarations to map input files, or the results of data communications) the programmer should review and check the structure declarations. It will often not be possible to interpret such data without a conversion routine (for example, to convert little-endian format integers to big-endian).

It is probably better to remove such dependencies; but it may be possible to work around them. By setting up the R30xx system to match the software's assumptions about endianness, and judicious use of the `#pragma pack(xx)` feature, the problem may be avoided.

- *Stack issues - varargs/alloca*: as pointed out above, the MIPS CPU doesn't have much in the way of a stack. The C stack is synthesized using standard register/register instructions to form a single stack containing both return addresses and local variables; but the stack frame may not be generated in functions which don't need it.

If the C code thinks it knows something about the stack, it may not work.

However, two respectable and standards-conformant macro/library operations are available:

- a) *varargs*: use this include file based macro package to implement routines with a variable number of parameters. C code should make no other assumptions about the calling stack.
- b) *alloca*: use this "library function" (it is implemented as a built-in by many compilers) to allocate memory at run-time, which is "on the stack" in the sense that it will be automatically freed when the function allocating the memory returns. Don't assume that such memory is actually at an address with some connection with the stack.

- *Argument passing – autoconversions*: arguments passed to a function, and not explicitly defined by a function prototype, are often “promoted”; typically to an *int* type, for sub-word integers. This can cause surprises, particularly when promoting data unexpectedly interpreted as signed.
- *Endianness*: the system architect may be able to configure the R30xx system to match the endianness of the existing system, to save the many trials described above.
- *Ambiguous behavior of library functions*: library functions may behave unexpectedly at the margins – a classic example is using the `memcpy()` routine (defined in many C environments) to copy bytes, and accidentally feeding it a source and destination area which overlap.
- *Include file usage*: this is closer to a system dependency; but the programmer can spend hours trying to untangle an incompatible forest of “.h” files. Moral: if a program is supposed to be largely OS-independent, try not to use the OS’ standard include files.

## CONSIDERATIONS FOR PORTABILITY TO FUTURE DEVICES

In general, it is difficult to perfectly plan for future, unknown devices. However, the techniques described above should minimize the effort required to take advantage of changing technology:

- *develop code portable across existing family members*. Future family members may continue to vary cache sizes, TLB structures, inclusion of FPA, etc. However, many of them can be expected to be compatible with the basic CPO mechanisms described in the earlier chapters. Code which is independent of cache size, resides in `kseg0` and `kseg1`, and which allows the inclusion of new/additional device drivers is likely to be readily portable to newer family members.
- *Use modular programming*. Specifically, map device specific functions such as cache invalidation, device initialization exception decoding and exception service dispatch, to independent modules (rather than intertwine these functions throughout the program). This will facilitate the porting to family members such as the R4600, which offer different CPO architectures.
- *Isolate the key algorithms to be device independent*. For example, image rasterization of routing table look-up should be implemented in code which is device independent (but may rely on underlying, independent exception or cache structures).

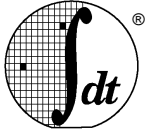

Integrated Device Technology, Inc.

## WRITING POWER-ON DIAGNOSTICS

## CHAPTER 12

Large companies with established product lines will already have guidelines for systems diagnostics; programmers may find this chapter useful for particular information about the MIPS architecture and how its features can be employed.

However, a large number of engineers will be dealing not just with a new CPU architecture, but also with a new level of system complexity. For those, this chapter is a pragmatic, hands-on guide to producing usable diagnostics. There is much academic literature about the efficiency and thoroughness of tests (particularly memory tests) which won't be addressed in this manual.

### GOLDEN RULES FOR DIAGNOSTICS PROGRAMMING

- *Test only the minimum required at each stage:* tests which run very early must be written in an environment which makes the programmers' life difficult. Whole chunks of the hardware cannot be trusted, the CPU may not be able to run at full speed, and it may be impossible to use high level languages.

The structure of the early tests is therefore pretty much unaffected by the hardware specification; they are focussed on getting enough confidence in the CPU, program memory and writable memory (and, more importantly, the interconnects between them) to make it safe to use high-level language routines.

- *Keep it simple:* diagnostic routines are particularly hard to prove, since the only way to check them is to simulate hardware faults. When the hardware really does go wrong, the diagnostics are quite likely to crash silently; a computer going wrong frequently goes so badly wrong that not even the most paranoid test will get running.

Routines so simple that they are almost certain to be correct by inspection will probably be robust when needed; and the programmer will be more confident in pointing the finger at the hardware.

- *Find some way to communicate:* the worst thing any diagnostic can do in the face of an error is to say nothing. But since most faults are near-catastrophic, this worst case happens often. The diagnostics programmer will therefore do everything possible to get diagnostic routines to do something visible with the absolute minimum of hardware.

Many hardware products are fitted with some kind of write-only output device with diagnostics in mind – perhaps an LED, a 7-segment display or (if the designer could afford its space and cost) a miniature alphanumeric LED or liquid crystal display showing 4 or more characters. This device should be wired up so that, provided the CPU and ROM memory are functional, the minimal amount of further hardware has to work for the display to show something.

Don't forget that even where software can't flash an LED, it can make software's activity visible to a simple piece of test equipment—a voltmeter, oscilloscope or logic analyzer. For example, the IDT Micromonitor will perform a software loop at an "error address"; a logic analyzer can then trigger on this address to see the sequence of events immediately prior to the error.

- *Never poll anything forever*: of course, it is common practice in simple device drivers to code a loop which is exited when some status bit changes. But when dealing with unproven subsystems, it is best to keep some track of real time so that the code can recognize that the status bit is not going to change, and report it.
- *Good diagnostics are fast*: some fault conditions are dynamic or pattern-sensitive, and careful, slow diagnostics won't ever find them.
- *Fighting past programmable hardware*: one major problem for the diagnostics programmer is the use of software-configurable hardware. For example, Algorithmics' SL-3000 single-board computer uses a VLSI component (VAC068) for the external bus address path. This component integrates a programmable address decoder and wait-state generator. This is convenient and saves a lot of random logic; BUT this means that even the simplest operations (e.g. access to a UART register) won't work until the VAC068 has been configured.

The hardware engineer should have been talking with the systems programmers about this as the system was designed, since it is quite possible to build a system which cannot be bootstrapped.

- *Work with (not for) the user*: good diagnostic tests may well be able to give quite a clear indication of where a problem lies. But never forget that diagnostics are meant to be run and watched by an intelligent, knowledgeable person. So give the user's intelligence a chance by being informative about what is happening. If a test prints out "Trying master access from Ethernet chip" and then nothing more, it is much more helpful than silently sticking in an infinite loop trying to figure out something more specific to say.

## WHAT SHOULD TESTS DO?

- *Diagnostics versus go/no-go*: a major conceptual difference; is the test intended to direct service or repair effort to a particular subsystem, or is it merely intended to come up with a "yes/no" answer?

In practice most test software seems to be expected to do both. This is not a major problem in terms of what is tested and how, but there is one big difference – time. A power-on "yes/no" test needs to be completed before it exhausts the patience of the person operating the power switch (empirically, 20 or 30 seconds seems about the limit).

A diagnostic test can run for much longer. To address both needs with one test, find some way of configuring the test so that it can be asked to be more thorough at the cost of taking longer.

- *Black boxes and internals*: in theory each subsystem can be treated as a "black box", purely in terms of its logical functions, and tested at that level without regard for its implementation. However, perfect tests usually require too long to run, and thus shortcuts are needed; knowing what shortcuts will be sensible is usually based on the internal design.

Build a simple logical block diagram of complex subsystems, working with the hardware designer, and refer to it when figuring out a test sequence.

Bear in mind that malfunctioning hardware can behave in ways which have no relation to its correct function. Note that this can cause "false positives"; for example when a write/read-back test returns correct data which has been retained by stray capacitance on a set of undriven signal wires (this is a fairly common occurrence in tests designed to determine the amount of system RAM available).

Hardware engineers will have some feel for what may happen inside a component when it is abused; for example, it is useful to know that certain kinds of timing violation will cause the loss of data in a whole "row" of cells inside a dynamic RAM chip.

- *Connections are more unreliable than components*: probably 10-50 times more unreliable. Short-circuits between signals are fairly common (very common on boards which have not been auto-tested) and can produce subtle and peculiar behavior.
- *Microcontrollers and other smart hardware*: any independently-acting programmable subsystem causes testing problems; this is probably the best reason for keeping subsystems dumb whenever possible. The same principles apply to test software executing on an intelligent subsystem, as to the whole test software. But communicating results to the user is often even more difficult.
- *Testing internals of components*: few systems really need to do this, or can do a good job of it. The diagnostics programmer can't find out how VLSI components are really built, so any tests beyond the simplest and most obvious are unlikely to be useful. What is possible is to set out to exercise components up from the most primitive operations they perform as "black boxes", with a view to proving the whole interface between the device and the rest of the system.
- *Specifying tests*: an art form, like any specification. DO agree in advance on how to signal information (LED flash codes, signal levels, logic analyzers); DON'T bother to agree in advance what algorithm to use for memory tests.

### HOW TO TEST THE DIAGNOSTIC TESTS?

Verifying the tests can be extremely difficult; the diagnostics engineer would ideally like to take the tests down all possible paths (e.g. the memory is good vs. the memory is bad). Doing so requires a method to make the test find faults in what may be an actual, good system. There are two primary techniques for doing this:

- *Software test harnesses*: these use some kind of simulator, which can be programmed to be defective.
- *Hardware test harnesses*: with this technique, hardware faults can be very tricky.

Do make sure that software is exposed to some basic tests. Many a highly-sophisticated memory test has continued running without reporting any faults despite a screwdriver shorting out RAM pins.

### OVERVIEW OF ALGORITHMICS' POWER-ON SELFTEST

This section describes the functions and construction of a set of ROM-resident test routines designed for Algorithmics' SL-3000 VMEbus single-board computer, which is based on an IDT R3081-40 CPU.

The primary purpose of the tests is as power-up confidence tests, which must run in a short period of time; but they can be configured (using information held in a small nonvolatile writable store) to run slowly and carefully. They are useful as diagnostics, particularly for units which are too faulty to load more sophisticated routines.

### Starting points

Unless a reasonable amount of logic is working correctly the SL-3000 will be unable to run test code. The minimum requirements are:

- *PROM*: is correctly readable.
- *Onboard data and address interconnects*: are fault-free, at least between the PROM and CPU (at least when all possible subunits are held in reset.)
- *CPU*: capable of executing code correctly.

The tests do not have to assume correct operation of the on-chip caches (they are tested), the FPA (the tests merely look to see whether there is one there, and the test software does not need it to work), and the TLB (memory-management hardware, described earlier.)

- *Error Reporting*: the SL-3000 has a front-panel 7-segment “hex” LED display provided mainly for this purpose. Where the console serial port is available, connected and functional it is used to provide fuller information.

In some circumstances the diagnostics will also leave warning messages and codes in the nonvolatile memory, for higher-level software to find.

Under serious failure conditions the tests make a last-ditch attempt to pass back information by a series of writes to PROM space; information is encoded in the store target addresses. The writes have no effect on the hardware†, but can be monitored with test equipment in laboratory conditions.

- *Underlying hardware*: the “minimal” functions described above implicitly require the use of other logic on the board. In particular, the VMEbus interface components (VIC068 and VAC068) integrate a variety of local bus control functions, and code will be impossible to run if these are faulty.

### Control and Environment variables

The nonvolatile RAM provides configuration and other information shared between several different levels of software. Rather than attempting to legislate for a rigid fixed-field map, the bulk of the NVRAM storage is organized as an “environment” modelled after the UNIX facility. This provides a set of key/value pairs, all of which are ASCII strings.

The environment is used both to set up options for the power-on tests (e.g. whether to spend time on thorough DRAM tests), and to return information discovered by those tests (e.g. to report the size of the caches).

The integrity of the environment store is protected by a checksum. If the power-on test detects a corrupted NVRAM, it will ignore the NVRAM contents and use a set of default values for the environment variables.

Users have to have some way of inspecting and altering the environment. Normally this will be provided as *setenv*, *getenv* commands implemented by an interactive ROM monitor. The power-on self-test code includes subroutines accessing the environment, but is designed to work with a variety of monitors.

A few NVRAM locations are predefined and strictly reserved for some other piece of software. They are ignored by the power-on tests.

### Reporting

Progress through the tests is shown as a sequence of numbers displayed on the front-panel LED. Failure is shown by a (possibly multi-digit) code flashed on the display.

Total collapse of the hardware under test is inferred by failure to keep incrementing the count, so the tests make sure that the display is changed every few seconds (exception: when the user has deliberately set an option variable to request the exhaustive version of a test, the user is expected to be patient).

Usually test progress and results are also reported to the console (always to serial port 0, always at 9600 baud); but most console output can be suppressed by setting an appropriate environment variable, in case some systems have some other equipment permanently attached to the console port. However, fatal error messages will be reported to the console regardless of the environment state.

---

† Such a methodology may not be compatible with the use of a ROM emulator; instead, it may be appropriate to define an “error reporting space” in the address map, which performs the appropriate handshake back to the CPU, but which does not decode into any actual memory devices.



### Unexpected exceptions during test sequence

If something is really wrong with the machine, the CPU will usually get some kind of exception (illegal instruction, illegal or unmapped address). These conditions are usually to be regarded as fatal. They are usually a sign of something very seriously wrong, so the priority is to make the code robust enough that something will get reported.

Exception reporting to the hex display should be done with the most pessimistic assumptions about the state of the machine; i.e. without using memory or the console. Once a minimal report has been made this way, it is permissible to assume memory is working in order to produce a better report to the console.

The boot test sequence will always use the “bootstrap exception vector”, described earlier in this manual, so that exceptions are trapped into PROM space with the instruction cache not used. Since the CPU can be reconfigured to vector exceptions through cached low memory, the test code does not have to provide any software mechanisms for intercepting its own exceptions.

### Driving test output devices

Test device software is pessimistic about the status of the hardware it talks to, to ensure that tests cannot be hung-up by malfunctioning outputs. For example, the serial port routines do not wait forever for characters to be transmitted.

### Restarting the system

System restart (as far as possible equivalent to a hardware reset) will occur if software jumps to the reset location 0xbf000000. No “warm restart” is provided for by this code; it is assumed that anyone wanting to preserve machine state will not want to run the test sequence.

### Standard test sequence

The tests are summarized in Table 12.1, “Test Sequence in brief”:

Mnemonic	Test summary
init	setup CPU and system (from a cold start)
vac-reg	register access tests on VAC068
led	display "8" then "0"
endian	check consistency of bigend jumpers and ROM, stop on error <i>can use byte variables now</i>
mem-conf	check memory size and that configuration is OK (there is a jumper which needs to match the type of DRAM chips used)
mem-min	uncached write/read address test on PROM data area <i>in C from here on...</i>
prom	checksum PROM sections and warn
nvrnm	checksum environment region, use defaults if wrong <i>can use environment variables from here on...</i>
cache	sizes caches and then performs internal write/read test (address in address)
refill	d-cache from PROM, then d-cache from main memory
vac-timer	check that programmable timers run, and that interrupt signals are reaching the VAC

**Table 12.1. Test Sequence in brief**

Mnemonic	Test summary
fpa	test for presence, interrupt wiring
nvr-am-rtc	check clock (built in with nonvolatile RAM module) for reasonable value, warn if it lost power.
vic-reg	register access tests on VIC068
vic-timeout	check local bus timeout
vic-timer	confirm timer working
vic-int	check that VIC interrupts are getting through to the CPU, and that the interrupt acknowledge mechanism works.
vic-scon	Is this system a VMEbus controller? set env variable
mem-best	fast address-based confidence check
mem-parity	check out that the parity check logic is accepting good and detecting bad parity
mem-soak	sequence of “thorough” memory tests
uart-reg	register write/read tests on 72001 (UART)
uart-init	initialize 72001 (suspiciously) and send a character
eth-reg	register access tests on SONIC
eth-read	get SONIC to read memory and check (also detects interrupt)
eth-write	get SONIC to write (or copy) memory and check
scsi-reg	register access tests on 53C710. Also check out the byte-swapper which is available for little-endian mode if required.
scsi-read	get 53C710 to read memory and check (and check its interrupt)
scsi-write	get 53C710 to write (or copy) memory and check

**Table 12.1. Test Sequence in brief**

## Notes on the test sequence

- *From Reset:* The CPU restarts at the usual PROM location, running uncached. This PROM is intended to restart in the same way regardless of whether the starting location was reached by a hardware reset or a software jump; so everything which can be is reset.

The sequence is complex and goes like this:

1. There is a branch instruction at the boot location. A failure to read the ROM correctly will lead to the CPU getting an immediate exception, failing to branch, or branching to the wrong address. All are pretty obvious to an engineer watching addresses on a logic analyzer.
2. Initialize the status register to place the CPU in a reasonable mode. Software preserves the prior-to-reset values of *ra* and *epc*. They have to be put into general purpose registers, since at this stage the memory can not be trusted.
3. The part of the ROM containing the test code is now check-summed. If this passes, ROM code should be able to be correctly read and executed. This is a reasonable piece of confidence testing, but in fact if the PROM doesn't work perfectly software would probably never have got here.  
Now perform IO system initialization.
4. Write to PROM space (required by the VAC068 chip to drop it out of “reset mode” – where ALL cycles are decoded as for ROM).

5. Initialize the VIC and VAC chips (which control onboard IO cycles) with a series of register writes. The register addresses, and the data to be written to them, are defined in a table – which, as it consists only of constant data, can be defined in a C module.
6. The SL-3000 is equipped with a board control register whose outputs hold various subsystems in reset; program it to reset everything which can be.
7. Program the serial ports. They can now be used for reporting any problem (although they cannot yet be trusted to work).
8. Wait 1 second while the user takes in the existing state of the LED (just in case it might be important).
  - *vac-reg*: a typical first test on an intelligent controller; pick a register which can be written with any 16-bit value, and read back, and which has no harmful side effects. This proves out the basic address paths in the IO system, and (half of) the data bus; and the system will shortly need to program the VAC device before many other parts of the system will work.
  - *led*: enable hex display and flash it from “0” to “8”. From now on software will go on flashing the display to demonstrate progress.
  - *endian*: check that the PROM endianness makes sense (up to this point all the code is “bi-directional”, which involves avoiding all partial-word loads and stores). If the board’s configuration jumper and the PROM type are mismatched, flash/print an error message and stop.
  - *mem-conf*: check that the board is not equipped with small DRAMs but configured for big ones (this state leaves holes in the memory).
  - *mem-min*: perform minimal memory test. In the event of any problems, report and carry on (no good can be accomplished by stopping).

These tests need only cover uncached accesses to memory made while running uncached from PROM, and can be restricted to that portion of the memory used by the PROM software. They need to be restricted too; since the system is still running uncached, a test of the whole of memory would take too long.

Once this has passed, the system is capable of supporting compiled test code.

- *prom*: compute and compare a simple 32-bit add/carry checksum on each “package” in the PROM, intended to detect single-bit dropout and mis-programming. A zero stored checksum (an impossible result with add/carry) suppresses the check for those who can’t be bothered to maintain the checksum during PROM development.
- *nvr*: verify checksum on NVRAM environment area. If it is wrong, use default environment settings. The default settings will cause tests to be more verbose and more thorough.
 

If environment does not suppress console output, print a console sign-on message.
- *cache*: figure out the size of the I- and D-caches, using the diagnostic isolate/swap cache features (see the chapter on cache management). The cache size is left in an environment variable, because system software will want to know it later.

Now do simple memory tests in the caches, using an address-in-data test to produce different patterns. The test is coded in C and run uncached, using a tiny assembler subroutine to read/write a single word in the cache; the emphasis is on making the code as obvious as possible. This module cannot be tested except by chance (since all R30xx family CPUs work and the caches are internal) – so it had better be right by design.

- *Refill from ROM*: check out cache refill from PROM. This exercises some logic which puts together ROM cycles into (slow) bursts on request, to allow ROM code to be run cached.
- *Refill from main memory*: the main memory logic provides real high-speed bursts of data. Check that at least a pattern (which is designed to cause each data bit to change as much as possible) can be read.

If all cache tests pass, further test software can be run cached where necessary. This is really needed – it is impracticable to run a thorough memory test in a reasonable period of time unless the caches are enabled.

- *vac-timer*: see whether the VAC timers will run.
- *fpa*: check for presence and consistent interrupt configuration, but do not expect to perform a functional test.
- *nvr-am-rtc*: check for a plausible value in the real time clock registers and record it.
- *vic-reg*: write/read test on VIC068 registers.
- *vic-timeout*: the VIC068 is used to timeout local bus accesses to nonexistent locations. Make sure this works and causes a bus error (involves catching the exception).
- *vic-timer*: check that the VIC068 interval timer is giving periodic interrupts.
- *vic-int*: check that VIC interrupts are getting through to the CPU, and that the interrupt acknowledge mechanism works.
- *vic-scon*: obtain whatever detail is available on the VMEbus environment without doing anything. This includes reporting on whether the board is configured as system controller, and the state of the backplane SYSRESET\* and ACFAIL\* lines.
- *mem-best*: “best-efforts” is necessarily relative to the amount of time allowed for testing memory (Algorithmics believes something around 10s is sensible). This small amount of time allows nothing more complex than an address-in-address test. Speed is probably more useful than theoretical thoroughness.

The diagnostic will report the memory size into an environment variable.

- *mem-parity*: use the diagnostic area to write bad parity to a memory location, and then test that it is detected and reported.
- *mem-soak*: optionally (enabled by an NVRAM environment entry) run a much more complete memory test. Parity checking can be used to detect errors.
- *uart-reg*: check out 72001 UART connections by write/read registers.
- *uart-init*: check out that serial ports are responding (to the extent possible without writing characters to any but the console).
- *eth-reg*: write and read-back test of register bits. Program up the controller and look for plausible status.

Note that no test is made for the presence of a transceiver or a network connection. Higher level bootstrap software should take care to report such conditions.

- *eth-read/eth-int*: persuade the SONIC to read memory as master, by issuing a “load CAM” command.

Completion of the load will cause an interrupt; track this through the VIC and to the CPU pin. Note that it is quite legitimate to do this with interrupts disabled in the CPU; the CPU can see the state of its pins.

- *eth-write*: persuade the ethernet to write something to memory and check it. This may involve an internal loopback command, but anything which writes memory will do.

After the test the ethernet controller will be reset.

- *scsi-reg*: register write/read of 53C710 controller.  
The way the SCSI controller is wired -up allows diagnostic software to check that the IO bus byte swapper is configured as expected by the PROM. This is particularly important because the byte-swapper is mainly used for network and SCSI data, and corruption to these won't be noticed until an embarrassingly long way into bootstrapping. Software records the actual CPU and IO endianness in environment variables.
- *scsi-read*: persuade the 53C710 to read memory (by persuading it to read a very simple SCRIPT) and check. This causes an interrupt, which the diagnostic checks can be delivered all the way to the CPU pins.
- *scsi-write*: get the 53C710 to write to memory and check it.  
Leave the SCSI controller reset after the test.

### Annotated examples from the test code

These examples concentrate on the first, low-level code which has to be in assembler (since writable memory is not yet trusted, and C code can't be used without some memory for a stack).

- *Starting Up*: the PROM is linked with its first module starting like this (observe that the “li” which identifies this as an absolute reset is explicitly placed in the branch delay slot of the jump):

```

        .text
        .set  noreorder
_bt_rvec:
        j  bt_bootpkg; li a0, 7
        ...
        /* a lot later is the exception vector, 0x180 bytes
        * up
        */
        ...
        j  it_bevgen; nop

```

This jumps to start off the real code, which in this case is designed for a PROM space broken up into “packages” each of which is a separately-linked program. But the first few instructions are likely to be required on pretty much any start-up PROM.

Zero is placed into *k0* because the exception routine uses this as a flag – a nonzero value in *k0* will be taken as the address of a user-installed exception routine.

```

LEAF(bt_bootpkg)

        move   k0,zero

        .set  noreorder

        li    s1,SR_BEV    /* complete SR initialization:-} */
        mtc0  s1,sr
        nop
        nop

```

After two “nop”s the new status register has taken effect and the CPU can be trusted. Software can now save the *epc* and *ra* registers, which are potentially useful in telling users what was happening before reset:

```

/*
 * save epc & ra so that they can be passed to package
 */

```

```

mfc0    s1,epc
.set    reorder
move    s2,ra

```

Now read the “package” record, which is a little bit of PROM space at a well known address (1024 bytes above the start of the PROM). Each of 8 possible records contains 4 words of information: a magic number, the start address, end address, a checksum, and a start location.

The register *a0* (conventionally used for the first argument of a subroutine) is used to pick one of 8 packages to run, and the 7th points to the start of the power-on tests:

```

        bltu    a0,NPKG,1f    # make sure package is in range
        li     a0,NPKG-1
1:
        /* get pointer to package info */
        sll    a0,PKGSHIFT+2
        la     s0,bt_pkginfo
        addu   s0,a0

        lw     t0,0MAGIC(s0) # get magic number
        li     a0,BT_BADPKG
        bne    t0,+BTMAGIC,bt_fail# must be same as us

```

Now the diagnostic will calculate a checksum for all the PROM locations for the code and constant data of the power-on test code. Note that, even without a stack, software can call a subroutine; recall that the MIPS hardware implements no stack functions, and the subroutine call instruction (“jal” for jump-and-link) puts the return address into register *ra*.

```

        lw     a0,0START(s0)
        lw     a1,0END(s0)
        jal    bt_chksum

        lw     t0,0SUM(s0)
        beq    t0,v0,1f      # good checksum?

1:
        /* jump at selected code */
        move   a0,s1
        move   a1,s2
        lw     t0,0ENTRY(s0)
        j      t0
END(bt_bootpkg)

```

Now the boot process really gets started. *it\_main* implements the test sequence. Once again it is possible to call one level of subroutine without a problem:

```

/*
 * entry point for integrated tests
 * a0,a1 contains epc,ra
 */
NESTED(it_main,0,ra)

        li     v0,SR_BEV|SR_PE
        .set   noreorder
        mtc0   v0,sr
        .set   reorder

        move   s0,a0
        move   s1,a1

```

```

/*
 * initialize the board and IO systems
 */
jal   sbd_init
jal   sbd_ioinit

/* to see LED state */
li    a0,250
jal   sbd_msdelay/* a VERY rough 250ms pause */

jal   sbd_basic/* tests before memory sizing */
move  s2,v0      /* save memory size */

li    a0,PA_TO_KVA1(0)
li    a1,0x10000
jal   sbd_memmin/* test 1 Mbyte of memory from 0 */

```

Now the software can trust the memory. After saving a few things in their assigned global locations, a stack is defined and the program is written in C:

```

/* at last put them into memory */
sw    s0,epc_at_restart
sw    s1,ra_at_restart
sw    s2,mem_size

/*
 * might have usable memory so give up on the
 * assembler and use C
 */
li    sp,PA_TO_KVA1(0xffffc)
jal   it_cmain

```

Note that it doesn't really return, just goes off and finds the next package.

```

jal   sbd_closedown

/*
 * tests have completed so execute next package
 */
move  a0,v0
j     bt_bootpkg
END(it_main)

```

This next section describes how some of the more significant subroutines are implemented.

- *sbd\_init*: The SL-3000 hardware suffers from intelligent peripheral controllers which require to be programmed in a precise sequence; until this is done many "normal" functions just don't work.

The code has to do a dummy write to ROM space first (the programmable decoder, from reset, will map every cycle onto ROM space):

```

/*
 * basic initialization
 */
LEAF(sbd_init)
/* kick VAC068 out of force eeprom mode */
sw    zero,PA_TO_KVA1(LOCAL_PROM)

```

Now the program uses a table of register addresses and values to be written to them. The table itself can be defined in a C module, making it readable and allowing the use of the same header files as for more complex device drivers:

```

        /* initialize VAC registers */
        la    a0,vicvacresettab
vicvacdefloop:
        /* v0 gets pointer to VIC/VAC register */
        lw    v0,0(a0)

        beqz  v0,vicvacdefend

        lw    v1,4(a0)
        sw    v1,0(v0)

        add   a0,8
        b     vicvacdefloop
vicvacdefend:

```

Now the board appears to work, so the code kind of starts again. The “BCRR” address is a hardware register whose outputs hold most subsystems in reset:

```

        /*
         * hold all devices in reset and disable LED
         */
        li    v0,BCRR_LBLK
        sw    v0,PA_TO_KVA1(BCRR)

        /*
         * VIC will bus error any accesses made while SYSRST
         * is active so wait until SYSRST goes away
         */
        li    v0,PA_TO_KVA1(BCRR)
1:      lw    v1,0(v0)
        and   v1,BCRR_SYSRST
        beqz  v1,1b

```

This breaks the earlier rules (this is a loop which can continue for ever) but with all local bus cycles being terminated with a bus error the system should not hang in an infinite loop.

The VMEbus power-on test convention is that each board should assert the SYSFAIL\* signal until it has passed its power-on tests. So for the moment, assert it:

```

        /* make sure that SYSFAIL is asserted with a 'reset'
         * code
         */
        li    v0,VIC_SYSFAIL|VIC_STATLRESET
        sw    v0,VIC_VSTATUS

        j     ra
END(sbd_init)

```

- *Doing without a stack*: more complex test software would like to be able to call subroutines. But without a memory-based stack, it is impossible to properly track the return address. Therefore, the early tests borrow three of the 32 registers and define a pseudo-stack and a couple of macros to use at the beginning and end of subroutines. These are for use in assembly code, but are implemented with the C preprocessor:

```

#define _t6$14
#define _t7$15
#define _gp$28

#define PUSHRA  move_gp,_t6; \

```



```

        move  _t6,_t7; \
        move  _t7,ra

#define POPRA movera,_t7; \
        move  _t7,_t6; \
        move  _t6,_gp; \
        move  _gp,zero

```

“POPRA” puts zero into the stack bottom; if the program should underrun the stack the result will be an attempt to return to address zero, which would be trapped by the memory-management hardware, if fitted.

The MIPS assembler defines the conventional register names using the C preprocessor; so to make sure these registers aren’t used, they are “undefined”:

```

/* of course this means the programmer can't use these... */
#undef gp
#undef t6
#undef t7

```

- *First test of first device:* on the SL-3000 board the VAC068 device (which connects the address lines of the VMEbus) integrates onboard device decode and control functions. Although it is initialized, unless it works nothing else will; so it must be a good place to start:

```

/*
 * The VAC has already been initialized
 * Here just try writing/reading a VAC register
 */
SLEAF(tst_vacreg)

/*
 * checkerboard test on VACPIODATO register
 * luckily this does not affect anything on the board
 */
li      t0,0xaaaa0000
sw      t0,VACPIODATAO/* store data in register */
not     t0
sw      t0,VACID/* complement to VACID (read-only) */
not     t0
lw      t1,VACPIODATAO/* reread register */
#ifdef ALLFAIL
xor     t1,0x80000000
#endif
and     t1,0xffff0000
bne     t1,t0,9f/* was it ok? */

```

Earlier, this chapter discussed the difficulty in testing the test software; the “#ifdef ALLFAIL” can be used to build in automatic failure, so at least the error reporting routines are tested.

```

/*
 * now try the other bits
 */
li      t0,0x55550000
sw      t0,VACPIODATAO/* store data in register */
not     t0
sw      t0,VACID/* complement to VACID (read-only) */
not     t0
lw      t1,VACPIODATAO/* reread register */
and     t1,0xffff0000
bne     t1,t0,9f/* was it ok? */

/* read the VAC ID register and check the contents */

```

```

lw      t0,VACID
and     t1,t0,VAC_IDENTMASK
bne     t1,VAC_IDENT,9f

/* return the revision ID */
and     t0,VAC_REVMASK
srl     t0,16
j       ra

9:      li      a0,IT_VACREG
j       _it_signal
SEND(tst_vacreg)

```

The routine `_it_signal()` attempts, by all means available, to communicate the result of a test:

- *Reporting errors without printf:*

```

/* assembler doesn't support character literals */
#define NL0x0a

/*
 * low level error report
 * trashes: a2;a0,v0,a1,v1
 */
LEAF(_it_signal)
    PUSHRA

```

Here is a use of the register-stack macro, allowing the error routines to nest to a depth of four:

```

jal     _sbd_signal

jal     sbd_displaycode

move   a2,a0 /* don't change sbd_printmsg :-) */

la     a0,errormsg
jal     sbd_printmsg

move   a0,a2
jal     sbd_printcode

li     a0,NL
jal     sbd_printc

POPRA
j      ra
END(_it_signal)

```

The constituent routines are:

- `_sbd_signal` controls one of the system's way of telling the world its troubles - in this case, by placing an error code in an 8-bit register dual-ported to the VMEbus (implemented in the VIC controller), and driving the wire-OR'ed VMEbus SYSFAIL line.
- `sbd_displaycode` uses the LED display to show the same 8-bit error value; it does this by blanking the display momentarily, then showing the byte value as two nibbles (most-significant first).
- `sbd_printmsg`, `sbd_printcode` between them report the error to the console. Used only for desperate conditions, it entirely ignores the user's expressed wishes about the serial ports - on the grounds that for a fatal error silence is always wrong. The "printcode" routine explains the error code with a message from the table `codemessages` (`tstmessages.c`).

- *Endianness-proof code and testing endianness:* the SL-3000 board can be set up (with option jumpers) to run either in big-endian or little-endian mode. Usually, software has to be built for the correct endianness, but Algorithmics wanted to ensure that the power-on test would at least tell the user if the jumpers were set wrongly for the installed ROM.

However, MIPS instructions are all 32-bit words, and are all designed as bit codes. Provided the system correctly wires up the bit numbers within each 32-bit word (which is the most “natural” way to wire up a 32-bit MIPS processor), the instruction encoding does not change between big- and little-endian. What does change is the effect of partial-word load and store instructions; but so long as the software doesn’t use partial-word operations the code will run in either mode.

A CPU can easily sense its own endianness by comparing the result of a byte load with the word-value contents of the location:

```

        .rdata
littleflag:
        .word 1
        .text
                .align 2
ycnegreme:.ascii"remEcneg 00 :y"

```

**It is quite difficult to spell in the wrong endianness...**

```

LEAF(tst_endian)
        la    v0,littleflag
        lbu   v0,0(v0)

#if BYTE_ORDER==LITTLE_ENDIAN
        beq   v0,zero,9f
#endif
#if BYTE_ORDER==BIG_ENDIAN
        bne   v0,zero,9f
#endif

        j     ra

9:
        la    a0,ycnegreme/* "Emergency" backwards */
        jal   sbd_printmsg

        li    a0,IT_ENDIAN
        /* message in code table is backwards too */
        jal   sbd_printcode

        li    a0,NL
        jal   sbd_printc

1:
        li    a0,IT_ENDIAN
        jal   sbd_displaycode
        b     1b
SEND(tst_endian)

```

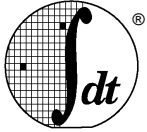

The great majority of MIPS instructions require their operands by the end of the “RD” (second) pipeline stage, and produce their result at the end of the “ALU” (third) stage. If all instructions could always stick to these rules, any instruction sequence could be correctly run at maximum speed. The great power of the MIPS architecture is that the vast majority of instructions can stick to this rule.

Where this can’t be done for some reason, an instruction taking operands from the immediately preceding instruction may not run correctly. A lot of the time, this will produce unpredictable behavior – a *pipeline hazard*, and it is up to the programmer, compiler and assembler (together) to keep those instruction pairs apart. This can sometimes be done by moving code around, but otherwise the programmer can insert a **nop**.

In other cases, the sequence will work but will result in execution pausing while the desired result is produced – an *interlock*. Compilers, assemblers and programmers would like to move code around to avoid interlocks too, to maximize performance.

Table 13.1, “Instructions with scheduling implications” lists all R30xx family (MIPS-1) instructions which either require their operands to be delivered earlier than usual, or which deliver their results late.

If one instruction delivers a result used by a subsequent instruction, and either instruction is listed in Table 13.1, “Instructions with scheduling implications”, the sum of the late-result count of the first instruction and the early-operand count of the second gives the number of **nop** or other intervening (non-dependent) instructions required to prevent a hazard or interlock.

A tick in the “hazard” column means that failure to observe these conditions will break a program – and the assembler, unless inhibited, will probably insert **nop** instructions to avoid the problem. No tick means the problem is interlocked.

### Notes and examples

- Any branch takes effect late, so the instruction following the branch is always executed. It’s often possible to move the last instruction which logically precedes the branch around; clever compilers may be able to figure out that the instruction normally at the branch target can successfully be put in the delay slot, speeding up loops; failing all else, the slot can be filled with a **nop**.
- A load from memory into any register produces its result late, so a “delay slot” is needed before the result is used:

```
lwc1    $f0, 42(t0)
nop
add.s   $f4, $f2, $f0
```

- A branch on FP condition needs the C bit early, so a gap is needed between a “set” instruction and the branch:

```
c.eq.s  $f0, $f2
nop
bc1t    thesame
```

Instruction	Early Operand	Late Result	Hazard?	Notes
Branch instructions		1	✓	where result is new "PC" value, i.e. delayed branch
Load instructions	lw, lh, lhu, lb, lbu, lwc1	1	3	load delay
lwl, lwr	0/-1	1	✓	late read of value to merge, so no delay needed between <b>lwl/lwr</b> pair
mult, multu		11		result interlocked
div, divu		35		result interlocked
Integer/control register moves: mfc0, mtc0		1	3	
FP conditional branches: bc1t, bc1f	1	1	3	
Integer/FP moves <b>mfc1, mtc1, ctc1, cfc1</b>		1	3	
FP addition unit ops <b>add.s, add.d, sub.s, sub.d</b>		+1		
mul.s		+3		interlocked
mul.d		+4		interlocked
div.s		+11		interlocked
div.d		+18		interlocked
cvt.w.s, cvt.w.d, cvt.s.d		+1		interlocked
cvt.s.w, cvt.d.w		+2		interlocked

**Table 13.1. Instructions with scheduling implications**

- The sequence below requires *two* nops (though this sequence may be highly unlikely)

```

ctc1    t0, $31
nop
nop
bc1t    somewhere

```

## ADDITIONAL HAZARDS

### Early modification of HI and LO

An interrupt or trap will abort most instructions, and the result writeback will be inhibited. But this isn't done in the integer multiply unit; changes to the multiply unit registers cannot be prevented once multiply and divide instructions start.

An exception might occur just in time to prevent an **mfhi** or **mflo** from completing its writeback, but still allow a subsequent multiply or divide instruction to start. By the time the exception completes (or equivalently,

by the time the exception routine saves the *lo* or *hi* register values) the multiply/divide could have overwritten the data and exception recovery won't happen properly.

To avoid this ensure that at least two instruction times separate an **mfi** or **mfo** instruction from a following multiply or divide instruction.

### Bitfields in CPU control registers

Some of the CPU control registers ("coprocessor 0") contain bitfield values or flags which have side effects on the operation of other instructions. Unless specifically documented below, software must assume that any such side effects will be unpredictable on the three instruction periods following the execution of an **mtc0**.

The following are specifically noted:

- *Enabling/disabling a group of co-processor instructions*: use of CP instructions in the following two instructions is unpredictable – in particular the CPU may, or may not, trap.
- *Enabling/disabling interrupts*: the enable won't allow an interrupt to affect (i.e. get in before, abort the writeback phase of) the following two instructions; it can happen before the third.

Similarly, when disabling interrupts the following two instructions may nonetheless be interrupted.

- *TLB changes and instruction fetches*: there is a 2 instruction delay between a change to the TLB and it taking any effect on instruction translation. Additionally, there is a single-entry cache used for instruction translations (called the *micro-TLB*) which is implicitly flushed by loading *EntryHi*, which can also delay the effect.

The OS should only perform TLB updates in code running in an unmapped space...

### Non-obvious Hazards

There are other device "hazards" which can't be determined by examining the processor pipeline. In general, these are due to the amount of time required for changes to CP0 registers to "propagate" to the cache, bus interface, or exception controller of the device.

The CPU hardware user's manual specifies a number of clock cycles, and whether software can operate cached, for modifications to R3041 and R3081 specific CP0 registers. The programmer is referred to those manuals for additional information.

One other common "hazard" bears particular note: modifying the IEC and IM bits of the status register in a single CP0 instruction is not recommended. The effects of these bit fields may or may not be seen in different clock cycles; thus, changing both with a single **mtc0** or **ctc0** instruction may result in side effects such as spurious interrupts (if for example the new value unmasked a previously masked interrupt but was also attempting to clear the global IEC bit).

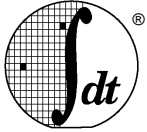

Integrated Device Technology, Inc.

## SOFTWARE TOOLS FOR BOARD BRING-UP

## CHAPTER 14

This appendix describes the software tools typically used by IDT when debugging a board for the first time.

Additional detail on the design and debug of R30xx systems is available from IDT in the forms of applications notes, evaluation boards, and design guides.

### TOOLS USED IN DEBUG

In a typical system, IDT engineers use the following tools for initial board debug:

- *Logic analyzer*: This tool is indispensable for determining why a particular memory sub-system is malfunctioning. Although other diagnostic tools are used to determine which subsystems are misbehaving, ultimately a logic analyzer is used to trace the misbehavior, so a work-around or fix can be applied.

The use of the logic analyzer may be complemented by the use of a device specific “pod”. These pods are designed to be inserted into the CPU socket, and recognize the device bus protocols. These pods typically can dis-assemble incoming instructions as well, facilitating debug of programs as well as hardware.

- *ROM emulator*: IDT frequently applies ROM emulator tools to minimize the hassle of burning new sets of EPROMs as higher levels of code is developed. A word of caution: some ROM emulators may take actions (desired or not) when the ROM space is written to; the hardware designer should review the requirements of the ROM emulator to insure system compatibility.
- *In-circuit Emulator*: In some cases, IDT will apply an in-circuit emulator to a debug task.

Many developers rely heavily on the use of in-circuit emulation for system debug; others rely exclusively on software-based debug techniques coupled with generic measurement equipment. In-circuit emulation can certainly be a useful tool, although it may prove to be outside the project development budget.

- *IDT Micromonitor*: The IDT micromonitor is a small program designed to help discover and debug problems in the system RAM.

Since the micromonitor is designed to help debug system RAM, it can not assume that RAM resources are available to it. Thus, the micromonitor is written in assembly and does not require a stack or variable storage; it uses the on-chip register file for temporary data storage.

For the Micromonitor to operate, the ROM sub-system must work, and the system console must work.

The Micromonitor contains a number of diagnostics for system RAM, designed to insure that address and data lines are correctly connected; that DRAM refresh works properly; that cached and uncached accesses function properly; etc. Successful use of the micromonitor gives the debugger confidence in the board memory system.

- *IDT/sim (system integration manager)*: This is a PROM monitor/debugger program, designed to run in a target system. IDT/sim gives the engineer the ability to set breakpoints, peek and poke memory, install new commands, examine machine state, single step, etc.

In addition, IDT/sim contains the communications interface to a number of host-resident remote target high-level language debuggers, including GDB and MIPS DBX. With IDT/sim executing on the target board, the programmer can perform high-level language debugging on the target from the development host.

## INITIAL DEBUGGING

When debugging is first begun, the engineer will not even be confident of the proper behavior of the ROM and RAM memory subsystems.

A number of techniques can be used during this initial debug. Some engineers prefer to use an in-circuit emulator with overlay memory to cause the CPU to make repetitive accesses to the memory while the engineer probes it with a logic-analyzer and/or oscilloscope. Other engineers will just “try the boot prom” and use a logic-analyzer to see the first few cycles after reset (typically to the boot prom). Again, a logic-analyzer pod may prove helpful in showing what instruction finally arrives back at the CPU data pins.

Debugging the ROM and UART subsystem are preliminary steps required for the micromonitor, SIM, and remote target debug. There is no particular “mystery” to doing this with the R30xx family; just good old-fashioned debugging.

## PORTING MICROMONITOR

Porting the micromonitor typically requires only two steps:

- *determining the UART address*: this will be system specific. In micromonitor, there is an assembler directive inside the source file used to define the UART\_BASE address. The programmer needs to modify this line to reflect the system address map.
- *provide the UART driver*: if the system uses an 8530 or compatible, or a 2681/68681 or compatible, then the programmer can use one of the drivers provided with the micromonitor. Otherwise, the programmer needs to provide a rudimentary UART driver for the system UART.

There is an advantage to patterning new drivers after UART drivers provided with the micromonitor. In general, a full device driver is probably not required--fixed baud rates, a single receive or transmit character from a CPU register, and programming in assembly are all appropriate to the goals of the micromonitor.

If selecting one of the existing UART drivers, the programmer should set the appropriate assembly file line to indicate the selected driver.

## RUNNING MICROMONITOR

The micromonitor documentation describes the proper running of the micromonitor program. In general, the micromonitor should be used until all of the diagnostic tests of system RAM can be completed successfully and repeatedly, running both cached and uncached.

At this time, the engineer is confident that the ROM and RAM systems operate correctly, and can be accessed cacheably (in four word bursts) and non-cacheably. In addition, partial word accesses to the system RAM are now verified.

The engineer is now free to move on to porting SIM, and debugging the remainder of the IO subsystems.

## INITIAL IDT/SIM ACTIVITY

The first goal for running IDT/sim is to merely get to the basic IDT/sim prompt. This should not rely on subsystems other than those already confirmed using micromonitor: the ROM, RAM, and UART. Thus, the only problems that should be expected are programming, not system, problems.

However, there is one common problem that can slow progress:



- *Improper memory sizing algorithm.* IDT/sim usually performs a RAM area sizing operation, to determine the amount of system RAM. It then places the stack pointer at the top of system RAM. If the memory sizing algorithm does not work properly, the stack could be placed in non-existent memory, or SIM could be fooled into thinking there is 0kB of memory. In either case, SIM would not boot or execute properly.

To avoid this problem many engineers “hard-wire” a memory size into SIM for initial boot and system test. For example, an evaluation board might be populated with 1MB of DRAM, and SIM hardwired for 1MB of RAM. The memory sizing algorithm could then be debugged later.

Once IDT/sim is at the system prompt, the engineer can complete the process of system debug. At this point, the ROM, RAM, and console UART subsystems are executing properly.

The engineer may choose to use “Peek” and “Poke” operations into the memory space to test accesses to peripherals, or instead may begin porting drivers and diagnostics. IDT/sim will provide a rich execution environment, including breakpoints, single step, cache and memory housekeeping, in-line assembly, download, etc.

The system engineer can also choose to apply other traditional microprocessor development tools, including ROM emulators, in-circuit emulators, and also use remote target debugging, during the actual system software port.

### **A FINAL NOTE ON IDT/KIT**

In addition to the functions found in IDT/sim, IDT offers the Kernel Integration Toolkit. IDT/kit contains many bits of “housekeeping” code for the system environment builder, including functions such as cache flushing/management software and exception decode and dispatch. IDT/kit contains the “processor specific” bits and pieces of an operating system, allowing the OS programmer to be freed from many of the details of the CPU architecture and implementation.

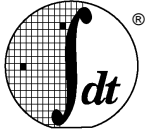
**APPLICATION SOFTWARE**

This example will use the most common first C program: “Hello World”. It will be run in RAM, by downloading it to an R30xx evaluation board using the IDT/sim PROM monitor. It is illustrative of a range of simple application programs and benchmarks which will probably work, regardless of hardware or operating system, and require no more than a ANSI C library.

```
#include <stdio.h>

main (int argc, char **argv)
{
    printf ("hello world!\n");
    return (0);
}
```

**Memory map**

A simple stand-alone program will usually have all of memory to itself, except for a small amount at the bottom (and possibly the top) which is reserved for use by the PROM monitor.

In such an environment, the programmer will not have to worry about virtual memory: the program can be linked to run in the cacheable kseg0 address region or, to see the program with a logic analyzer, in the uncacheable kseg1 region. These regions map one-to-one with physical memory.

A typical base address for the program code would be 0x80020000 (i.e. at offset 0x20000 in the KSEG0 region). This leaves 128 Kbytes free for the PROM monitor’s own data and stack, which is enough for IDT/sim. Above this will come the program’s initialized data, then BSS (uninitialized data), followed by its “heap” (free memory for use by *malloc et al*). The PROM monitor will usually put the stack pointer near the top of memory, and the stack and heap will grow towards each other.

**Starting up**

Having downloaded the program to the evaluation board and told the PROM monitor to start the program, it will set the stack pointer to the top of memory and jump to the program’s *entrypoint*, often defined by a label with a standard name (e.g. *\_start*), or simply by jumping to the first address in the program.

The code following the entrypoint has to ensure that the run-time environment required for a C program and library is set up. For a downloaded program this is usually a simple matter of zeroing the BSS segment, and initializing the *\$gp* register and stack. It should then call the program’s *main* function, after ensuring that its *argc*, *argv* and *envp* arguments are initialized. If *main* returns, then its return value is passed to the *exit* function, which will close open files and in turn call *\_exit*. The *\_exit* function should transfer control back to the PROM monitor (the exact manner this is done is system or tool dependent)†.

The following code fragment shows how a start-up module might be implemented; it is commonly provided as part of the development system.

---

† The above functionality is provided by the “*idt\_csu.S*” program provided with IDT/c.

```

        .comm environ,4

        .data
#defineARGC 1
argv0: .asciiz"prog"
argvec:.word argv0, 0
envvec:.word 0

        .text
LEAF(_start)
        /* initialize $gp */
        la    gp,_gp

        /* clear the BSS */
        la    t0,_fbss
        la    t1,end
1:      sw    zero,0(t0)
        addu  t0,4
        bltu  t0,t1,1b

        /* make sure stack is in same KSEG as .data */
        and   t0,sp,0x1fffffff # get stack physical
                                # address
        and   t1,~0x1fffffff # get KSEG of "end"
        or    sp,t0,t1        # put sp in same KSEG

        /* align to 8 byte boundary and allocate an argsave
        area */
        and   sp,~7
        subu  sp,16

        /* initialize argc, argv, and environ (IDT/sim zeroes
        a0-a2) */
        li    a0,ARGC          # dummy argc
        la    a1,argvec        # dummy argv
        la    a2,envvec        # dummy envp
        sw    a2,environ

        /* exit (main (argc, argv, environ)) */
        jal   main
        move  a0,v0
        jal   exit

        /* in case exit returns */
1:      break 1
        b    1b
END(_start)

LEAF(_exit)
        li    ra,0xbfc00000+(17*8)# IDT/sim prom return
                                # vector
        j     ra
END(_exit)

```

## C Library functions

Many C application programs will expect to have access to a C library which conforms to the ANSI definition, as described in [reference K&R]. Most development systems will supply a library that conforms to at least some parts of this standard. The rest of this section follows Appendix B of [reference K&R] to warn the programmer about those areas where some cross-development system libraries may deviate from the standard – refer to the toolchain documentation for specific information.

### Input and output

The `<stdio.h>` header file is almost certain to be present, but the library will often provide only a small subset of the expected standard i/o facilities. In particular it will usually provide access to only a single console device via `stdin` and `stdout`, with no file i/o. Some systems may provide remote file access facilities, but this is often via a distinct set of non-standard function calls†.

- *File operations*: are unlikely to be present, and if they are will usually support only the system console device.
- *Formatted output* : the `printf` functions will usually be present, but may omit some of the newer ANSI formatting options, and may not support floating-point formats.
- *Formatted input* : the `scanf` functions are often absent.
- *Character input and output*: usually provided, but often only to the system console.
- *Direct input and output*: sometimes provided, but often only to the system console. or serial I/O ports.
- *File positioning*: probably absent.
- *Error handling*: probably absent.

### Character class tests

The `<ctype.h>` header file and its associated functions and/or macros are usually provided. The `isxdigit` function is sometimes absent or has a different name.

### String functions

The older string functions are usually present, although often not very optimized. Some of the newer string functions such as `strspn`, `strcspn`, `strpbrk`, `strstr`, `strerror` and `strtok` may be absent.

The `mem...` functions are sometimes absent, and in their place the older `bcopy`, `bcmp` and `bzero` functions may be provided.

### Mathematical functions

The mathematical functions, if provided at all, will often be in a separate maths library. If this library is supplied, it will probably implement all of the required functions. Note that it may be impossible, or tricky, to run floating-point code on CPUs which do not have an on-chip FPA. Even if it does have one, the system may still need a trap handler for serious floating-point use). Some compilers can be instructed to implement floating-point operations by making calls to an emulation library.

### Utility functions

The `strto...` functions are sometimes absent, but the older `atoi` and `atol` will usually be available. The floating point conversions may be absent.

The following functions are often absent: `rand`, `srand`, `atexit`, `system`, `getenv`, `bsearch`, `qsort`, `labs`, `div` and `ldiv`.

The `malloc` family will probably exist in some form, although `realloc` is sometimes absent. At the lowest level they will probably call the `sbrk` function to acquire memory from the system, which the programmer may be required to implement. A simple `sbrk` will just return consecutive chunks of memory starting from `&end` (i.e. just after the program's declared data), until it reaches somewhere near the bottom of the stack, as follows:

---

† The IDT/c toolchain does provide many of these and other referenced functions. The programmer should consult the reference manuals for a particular toolchain to determine which functions are supported.

```

extern char end[];
extern int errno;
static void *curbrk = end;
static void *maxbrk = 0;

#define MAXSTACK (64 * 1024)

void *
sbrk (int n)
{
    void *p;

    /* calculate limit for curbrk on first call */
    if (!maxbrk)
        maxbrk = (void *)&n - MAXSTACK; /* &n is approx value of
                                           $sp */

    /* check that there is room for this request */
    if (curbrk + n > maxbrk) {
        /* no room */
        errno = ENOMEM;
        return (void *)-1;
    }

    /* zero the requested region */
    memset (curbrk, 0, n);

    /* advance curbrk past region and return pointer to it */
    p = curbrk;
    curbrk += n;
    return p;
}

```

### Diagnostics

The `assert` macro is often absent.

### Variable argument lists

Variable arguments are usually supported, but sometimes only via the old *vararg* mechanism rather than the newer ANSI *stdarg*.

### Non-local jumps

The `setjmp` and `longjmp` functions are usually supplied.

### Signals

It is unlikely that the signal functions will be supported, although sometimes a limited form is provided in order to support SIGINT only.

### Date and time

It is likely that none of these functions will be available. Timing benchmarks will often require a stop-watch, or some software mechanism which is very specific to the PROM monitor and/or development system<sup>†</sup>.

### Running the program

Having typed in the “hello world” program, the programmer must then compile it, link it, and convert it into a form suitable for downloading to an evaluation board. This process is very dependent on the particular

---

<sup>†</sup> IDT typically provides timer utilities as part of a utility disk provided with an evaluation board, and also with the IDT/c toolchain. These utilities are often board specific, since they rely on an underlying hardware timer mechanism.

development system, which should provide some sort of automated mechanism: many UNIX-hosted toolchains provide a set of *makefiles* which control the whole process, via the well-known *make* utility.

When the compilation has completed successfully, a down-loadable file is created (typically using S-records or other standard format). Downloading this file will require the use of a terminal emulator (in IDT/sim, use the “load” command on the board, and the “cp” command on the host), or some other special utility, to transmit the file down an RS232 line to the board. More advanced evaluation boards may provide an Ethernet or parallel interface in order to download large programs at high speed. Finally, it is then only necessary to instruct the PROM monitor to execute the program.

So a complete edit, compile, download and run cycle on a SUN platform using IDT/c might look like this:

*On development system:*

<b>C&gt; cd /idt/samples</b>	<b><i>change to source code directory</i></b>
<b>C&gt; vi hello.c</b>	<b><i>enter/edit the source file</i></b>
<b>C&gt; cp MakeBE Makefile</b>	<b><i>create the makefile from the template</i></b>
<b>C&gt; vi Makefile</b>	<b><i>change "stanford" in template to "hello"</i></b>
<b>C&gt; make</b>	<b><i>compile and link for IDT 79RS385 board ; this creates a "hellof.srec" file</i></b>

*On eval board's console:*

IDT>> **l -a tty1** ***srec download via RS232 port #1***

*On development system:*

**C> cat hellof.srec > /dev/ttyb** ***download via ttyb port***

*On eval board's console:*

IDT>> **go** ***start the program***

## Debugging the program

Hopefully not too much can go wrong with “hello world”, but larger application programs may require some debugging before they work.

Most PROM monitors, including IDT/sim, incorporate a command-line driven, machine-level debugger. This will allow the programmer to disassemble the code, examine registers and memory, set breakpoints and single-step through code one machine-instruction at a time.

Source-level debuggers allow the programmer to work in terms of the original source code and data structures instead of MIPS machine instructions. These debuggers run on the host development system – so that they can get at the source files and compiler-generated debugging information. They operate the program on the evaluation board by “remote control”, via a serial line or network connection. Many PROM monitors will incorporate a special protocol to support this feature, although some may require that the code for it be downloaded along with the program.

Source-level debuggers may themselves be command-line driven (e.g. MIPS *dbx* and IDT's/GNU's *gdb*), or may offer a multi-window, GUI interface. In all cases they are very complex programs, with many different commands and options. The development system's documentation should provide more details of how to use them with a target board.

## EMBEDDED SYSTEM SOFTWARE

Many aspects of “embedded software” are the same as “application software”, and its early development may be carried out in exactly the same way, on an evaluation board. But ultimately it is likely to be running in EPROM, on custom hardware, and require lower-level access to the processor in order to initialize it, test it, and handle machine traps and interrupts.

## Memory map

Compared to a program which is downloaded into RAM, embedded software will (at least initially) have its code and read-only data in EPROM. The EPROM, and thus the code, should be located at physical address 0x1fc00000, which corresponds to the processor's reset vector of 0xbf000000. The data area should probably be located near the bottom of RAM (DRAM or SRAM), but just above the area used for the processor's (non-boot) exception vectors: 0x400 should be safe for all existing RISController processors. Device registers should be decoded at high physical addresses, but below 512 Mb. If the hardware engineer suggests putting RAM at anywhere other than zero, or device registers anywhere outside of the bottom 512 Mb, then complain loudly: it will make software much more complicated, and performance may suffer.

## Starting up

After a hardware reset, code will be running in KSEG1 (i.e. uncached), with the caches, TLB (if present), internal registers, and RAM in an undefined state. Its first job is to initialize these resources. A detailed discussion and example of this can be found in earlier chapters of this manual.

For higher performance, code will need to be located in the cacheable KSEG0 region (i.e. at 0x9fc00000), rather than the uncached KSEG1 (0xbf000000). This has implications for start-up code. Before the caches are initialized, branches and absolute jumps (i.e. **j** and **jal**) are safe, because they do not alter the top four bits of the program counter, but any reference to data, or an attempt take the address of a function for use with **jr** or **jalr** will generate a KSEG0 address before it is valid to do so. The programmer must take care that any such references are explicitly mapped to KSEG1, by logically or-ing in the KSEG1 base address (i.e. 0xa0000000). Once the caches are initialized, switch to running cached by use of an explicit **jr** instruction, as follows:

```

/* switch to running cached, if so linked */
la t0,1f
jr t0
1:

```

Even running cached from EPROM will not give optimal performance, since cache refill cycles from EPROM will be slower than from RAM. A higher performance option is to link the code to run in RAM, and arrange for the start-up code to copy itself and the rest of the software from ROM to RAM. This is also useful when debugging the ROM, since it is not possible to set breakpoints or single-step code which is in ROM. Note, however, that this requires even more careful programming of the start-up code. Even jumps cannot be used until the code has been moved: only pc-relative branches are safe, and the **bal** instruction should be used in place of **jal** (though beware its limited +-128Kb range). Any attempt to access data or take the address of a function must be relocated by explicitly adding in the offset between the code in RAM and its temporary location in EPROM. It is sensible to calculate this offset just once, and keep it in a reserved register, such as *\$k1*.

Another complication is initialized data. Initialized data can be declared in assembler or C, e.g.

```

.data
base: .word 10

```

or

```

int base = 10;

```

The initialized data is writable, and so must be in RAM. But how does it get there?

Some cross-development toolchains are not very helpful, and require that all data must be either uninitialized, or if initialized then read-only. Other toolchains provide various different mechanisms by which to initialize this data. SDE-MIPS, for example, takes the straight-forward step, when generating a ROM image, of placing a copy of the initialized data segment (i.e. *.data*) at the next 16-byte boundary after the code. It is then easy to copy this from ROM to its final in RAM.

The following code fragment illustrates a flexible mechanism for handling these different possibilities for moving code and data to RAM.

```

_reset_vec:
    b _reset
    ...

_reset:
    move k1,zero           # assume no relocation
    bal 1f                # ra := current pc
1: la t0,1b              # t8 := linked pc
    beq t0,ra,2f          # when they match, then no reloc is
                        # correct

    /* executing at other than the linked address */
    li k1,0xbfc00000     # k1 := actual EPROM base
    la t0,_reset_vec     # t8 := linked EPROM base (may be RAM)
    subu k1,t0           # k1 := reloc factor (actual - linked)
2:

    /* initialize CPU, RAM, caches, tlb & stack
       (hardware specific) */
    ...

    /* skip code move if it is linked for ROM */
    and t0,k1,~0x20000000 # ignore simple KSEG1->KSEG0 reloc
    beqz t0,3f

    /* copy code to linked address in RAM */
    la a0,_ftext         # a0 := destination (RAM) address
    addu a1,a0,k1        # a1 := source (ROM) address
    la a2,etext          # a2 := code size (etext - _ftext)
    subu a2,a0
    bal memcpy

3:
    /* copy initialized data to RAM (SDE-MIPS specific) */
    la a0,_fdata         # a0 := destination (RAM) address
    la a1,etext          # a1 := source address (after ROM code)
    addu a1,k1
    addu a1,15           # round address up to 16-byte boundary
    and a1,~15
    la a2,edata          # a2 := data size (edata - _fdata)
    subu a2,a0
    bal memcpy

    /* jump to C start-up at linked address */
    la t0,_start
    j t0

```

### Embedded system library functions

Embedded system software written in C or C++ will still need access to the MIPS Coprocessor 0 registers and instructions in order to control interrupts, catch exceptions, handle the caches and TLB, and so on. Some cross-compiler vendors will supply a toolkit of low-level library routines to do this, and sometimes it will include full source code. At a minimum such



a kit should include assembler functions which read and write each CPU control register, initialize and update the TLB (if present), and initialize and invalidate all or part of the caches. Unfortunately there are no standard interfaces for these functions, and the programmer will have to read the cross-development system's documentation. The examples in this manual could serve as a baseline reference for programmers which choose to generate these functions themselves.†

### Trap and interrupt handling

Beyond routines to manipulate the CPU control registers and caches, the system software may need a mechanism by which to catch machine exceptions (the generic name for traps and interrupts), and cause appropriate C handler functions to be called. Vendor-supplied embedded system toolkits probably contain some code to help with this, although this is often at the very low level, and require more work to interface to C-level functions. SDE-MIPS includes some relatively high-level exception handling code that allows the programmer to route different exceptions to different C functions, and pass them a pointer to a structure which contains the complete CPU context at the time of the exception.

#### Choices about stacks

An exception handler has several choices regarding its use of stacks:

- 1) Remain on the current stack, shared with the main, or current application. This is usually adequate for simple, single-threaded applications.
- 2) Have an exception stack, which it switches to upon receiving an exception when not already at exception level. This avoids overrunning an application's stack, if it is small, and avoids problems if the exception was caused by a bad value stack pointer value.
- 3) Have several exception stacks, one per "process". This is essential in multi-processing applications.

### Simple interrupt routines

If any of the CPU's six interrupt pins or two software interrupt bits are active, and not masked by the CPU's *Status* register, the CPU takes an immediate Interrupt exception. Once the generic exception handler has routed the exception to the specific Interrupt exception function, it is the this function's responsibility to sort the interrupts into priority order and dispatch to the correct device's interrupt handler. The simplest technique is to make interrupt priorities correspond directly to interrupt pin number, allowing a simple bit-scan of the *Cause* register.

A very simple, fixed-priority interrupt handler might look something like this:

```
extern void softclock(), softnet();
extern void diskintr();
extern void netintr();
extern void ttyintr();
extern void fpuint();
extern void clkintr();
extern void dbgintr();

/* interrupt handler table */
void (*intrhand())[8] = {
    softclock,          /* [0] SInt0: clock */
    softnet,           /* [1] SInt1: network */
    diskintr,         /* [2] Intr0: disk controller */
    netintr,          /* [3] Intr1: network interface */
    /* ... */
    /* ... */
    /* ... */
    /* ... */
    /* ... */
    /* ... */
    /* ... */
    /* ... */
};
```

† Alternately, the programmer could obtain IDT/sim and/or IDT/kit from IDT, or a similar product from other 3rd party tools vendors.

```

ttyintr,          /* [4] Intr2: uart */
fpuintr,         /* [5] Intr3: fpu interrupt */
clkintr,        /* [6] Intr4: timer interrupt */
dbgintr         /* [7] Intr5: bus errors, debug
button, etc. */
};

/*
 * Interrupt exception handler.
 * 1) The xcp argument points to a structure which maps to
 *    the stack frame in which the CPU context (i.e. all
 *    registers) are saved.
 * 2) On entry all interrupts are masked (disabled).
 * 3) It calls the mips_setsr() function to modify the CPU
 *    Status register.
 */

interrupt (struct xcption *xcp)
{
    unsigned int pend, intrno;

    /* find all pending, unmasked interrupts */
    pend = xcp->cause & xcp->status & SR_IMASK;

    /* dispatch each pending interrupt, starting with
     * highest */
    for (intrno = 7; (pend & SR_IMASK) != 0;
         pend <<= 1, intrno--) {
        if (pend & SR_IBIT7) {
            /* enable only interrupts of higher priority
             * than this one. */
            unsigned int imask = SR_IMASK << (intrno + 1);
            mips_setsr (imask | SR_IEC);

            /* call interrupt handler */
            *intrhand[intrno] (xcp);
        }
    }

    /* disable all interrupts */
    mips_setsr (0);
}

```

### Floating-point traps and interrupts

The previous section shows how to recognize a floating point interrupt. Following the interrupt the *EPC* will either point at the FP instruction or (if the FP instruction is in a branch delay slot) at the immediately preceding branch.

To find out what happened, look first at the CPU *Cause* register. If it shows a “co-processor unusable” condition, then the FPA instruction set is not enabled. If it shows an interrupt at the FPA’s level, the handler can get further details of exactly what has gone wrong by consulting the floating point status register. However, there are only three cases of interest:

- The FPA is disabled ( $CU1 == 0$  in the CPU status register). If the CPU does not have an FPA, the software might want to emulate the instruction. If the FPA is available, the system might have been doing an “enable-on-demand”†. If so enable it and return to retry the instruction.

- The chip includes an FPA, and it's enabled, and the *FCR31* UnImp bit is set. The FPA has interrupted because it can't perform this particular operation, with these particular operands. The normal approach is to emulate the instruction – though in this case software will want to put the result back in the real FP registers.

In theory there are a rather restricted range of operations and operands which cause this condition: underflows, operations which should produce the “illegal” NaN value, denormalised operands, NaN operands, and infinite operands.

The system could put in special case code to handle just these conditions. But it is very hard to get assurances about exactly when the FPA may refuse an operation.

- The system has an enabled FPA, and the FP status register UnImp bit is clear. It looks as if the FPA operation has produced an IEEE-exception. Software may need to report this to the application, in some OS-dependent manner.

### Emulating floating point instructions

- *Locate the instruction*: it will either be at EPC (when the CPU status register, *SR* bit BD, is clear); or when BD is set, indicating that the exception happened in a branch delay slot, the FP instruction will be at EPC+4.
- *Decode the instruction*: The encoding of FP arithmetic instructions is very regular.
- *Fetch the operands*: the instruction encoding tells which FP registers hold the operand(s).
- *Call the emulator*: to perform the actual operation.
- *Check for exceptions*: if there are any enabled IEEE exceptions. If the system architect knows that IEEE exceptions can't usefully happen (perhaps because there is no mechanism in place for applications to catch them), skip this stage.
- *Patch the result*: back into the appropriate FP destination register.
- *Hop over the emulated instruction*: if BD was clear, just restart at EPC+4.

But if BD was set the program is going to have to decode and emulate the branch instruction (at EPC) too, and restart at the branch target location.

### Debugging

Once the developer leaves behind the relative safety of a PROM monitor and its debug support to develop the system PROM, finding out why the code is not working correctly may become much more tedious.

At the worst, the programmer will have to use judicious calls to `printf`, link the program in KSEG1 (i.e. uncached) and monitor CPU addresses with a logic analyzer. Armed with a list of function addresses (e.g. the output of the *nm* utility), and possibly a detailed disassembler listing for the suspect function, it is often possible to deduce the bug. It is seldom necessary to capture data values, although a few bits or a byte can be useful if the analyzer has enough probes.

Some vendors offer R30xx disassemblers and special pods for an analyzer to trace both instruction and data accesses.

Another technique is to include support for remote source-level debugging in the new PROM. The use of a ROM emulator device may prove helpful. This would allow the debugger to place “breakpoints” into the ROM code.

---

† Some systems do this to avoid saving FP registers at context switch if the application is not using the FPA.

## UNIX-LIKE SYSTEM S/W

It is obviously impossible, in a few pages, to give a comprehensive description of a big operating system. This section will provide some background on what a portable big system does, and how it does it on MIPS – so if the system needs to implement some fragment of this functionality the programmer won't be starting entirely from scratch. In specific examples shown, the description below relates to the freely redistributable “NetBSD” system, part of the Berkeley family.

The description is arranged as follows:

- *Terminology*: key words, often used with very particular meanings in Unix-like systems:
- *Components of a process*:
- *Protection*: how the kernel protects itself and other processes from misbehaving software;
- *Kernel services*:
- *Virtual memory*: how the MIPS architecture is used to build VM.
- *Interrupts*: how the CPU's features relate to the needs of the OS.

### Terminology

- *Task*: a thread of control, identified by a program counter and a stack. In other contexts this may be called a “process” or “thread”.
- *Address space*: the program memory context seen by an application. For MIPS this is a single, simple 32-bit space, divided into two. The lower 2Gbytes is accessible in user mode, but the upper 2Gbytes is not usable except in kernel mode. Note that the address mapping doesn't change with CPU mode. There are no segments, no separate I- and D-space.

This MIPS model fits very well onto the BSD family of Unix-like systems, and was probably conceived with BSD's requirements in mind.

- *Program*: a bunch of code and data initialization, held on disc and loaded when required.

A “process” combines all these three: it is a task in an address space running a program.

- *File*: a named sequence of bytes coming from “outside”. At its simplest it is just data which can be written out to disc and subsequently read back.
- *Device*: abstract, fairly unified interface to diverse real-world peripherals. Devices are named like files, and offer the same basic byte-stream model. Beneath this interface the kernel buffers data, handles interrupts and hardware details, and also provides an escape mechanism to keep device-specific functions tidy.

“Device drivers” are the lowest layer of kernel software which deals with hardware, and are supposed to isolate dependencies on particular controllers/peripherals.

Network interfaces are handled differently, and networking code is way beyond the scope of this chapter.

- *Page fault*: the OS maintains a mapping of program (virtual) addresses to physical addresses. But it doesn't have to keep all the process pages in memory. Access to a page for which no translation is defined causes a trap (a *page fault* which invokes a piece of software which checks that the address is legitimate, and if so brings the page into memory. When a page is touched for the first time, it will either be loaded from disc (if it is program text or initialized data) or supplied set to zero (if it is uninitialized data or stack).

## Components of a process

The above description refers to a BSD “process” as a task, address space and program all at the same time. This is a restriction, but it does keep things simpler.

“Processes” are laid out in memory as shown in Figure 11.1, “Memory layout of a BSD process”.

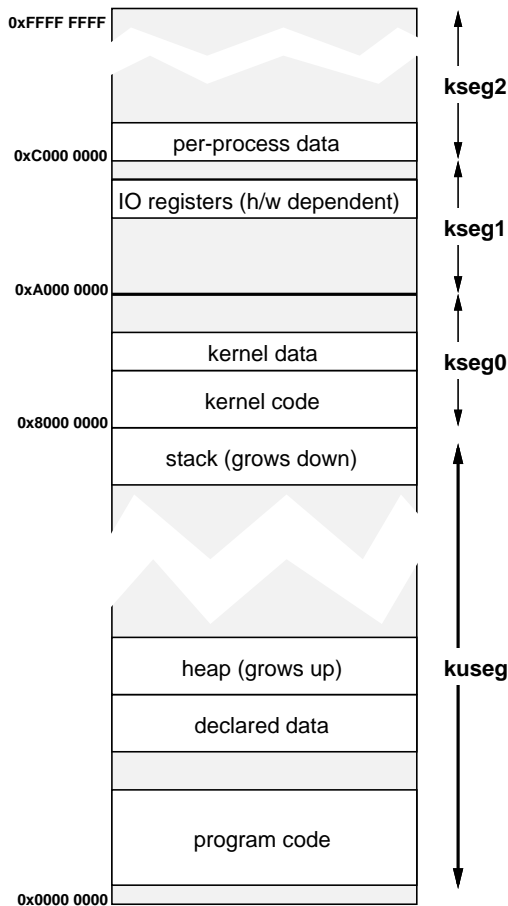

**Figure H.1. Memory layout of a BSD process**

- **Program text:** every process has a program in memory which it can run (it may be “virtual memory”, but to the process it seems to be there).
- **Stack:** every process has a stack, which grows downwards from the top of the user-accessible space. Since the MIPS architecture has no architecture-specified stack pointer, the OS is always willing to allocate pages of memory in the stack region if ever the program gets a page fault.
- **Declared data:** the data declared in a C program is noted in the object file, and explicitly accessed by compiled-in code. Initialized data is paged from the program file as needed, uninitialized data is supplied as zero-filled pages.
- **Heap:** this is the traditional name for data space allocated during program run-time. At the top of the data section the kernel maintains a boundary address (the *break*); on a page fault addresses above this are rejected as invalid. To allocate extra data the process can invoke the *sbrk()* system call; this is usually done implicitly when calling a free-space manager function such as *malloc()*.

- *Kernel data structures*: when a process in BSD makes a system call the process continues execution, but in kernel mode. Some kernel activity (such as interrupts) doesn't run on a particular process context, but most does.

So important parts of the process address space are inside the kernel, and are not accessible while the process is running in user mode. In particular, the process in kernel mode gets access to the whole kernel code and data (mapped into `kseg0`) and to all IO registers (mapped in `kseg1`).

It is a boon that, while a process is running in the kernel, all its user-mode data is accessible at exactly the same addresses as in user mode. Some architectures have to implement a special-case “copy user data to/from kernel space” instruction.

- *proc structure*: lurking in the kernel data area are the two key data structures which define the process. Why two? The smaller of these is the `proc` structure and contains information which may be required even when the process is not itself executing, and;
- *per-process data area (u area)*: this is the larger process structure, and is accessible only when the process is active. By a special trick of the MMU, the per-process data area is mapped to a constant virtual address inside the kernel, in the `kseg2` region.
- *kernel stack*: attached to the per-process area, mapped into `kseg2`, is the stack used by the process when executing in the kernel. It is this stack which is “borrowed” by interrupts.

## System calls and protection

One of the goals of BSD is protection for robustness; to ensure that a user-level program which goes wrong cannot disrupt the rest of the system. This is basically achieved by the process address space:

- In user mode, the process can only get at its user-mode virtual addresses, which are only those pages allocated by the kernel.
- To get into kernel mode, the process has to drop through a *system call* trap and can then perform only the function the system call allows. It is the duty of the system call itself to check its arguments for sanity, and to make sure that it behaves properly.

Interrupts and inadvertent traps behave much like system calls, albeit ones which don't work on behalf of the user process.

Of course, since the process has the whole kernel mapped it can at any time attempt a reference to kernel code or data; but in user mode this will be immediately trapped, and find its way to a memory reference error handler – which by default will kill the process.

R30xx security features are pretty much the minimum that will support a BSD-style OS. Many architectures offer much more; but portable OS', since they want to be portable, use only the lowest common denominator of security functions – and since all significant microprocessor OS' are now portable, the extra functionality is wasted.

## What the kernel does

In the BSD system the kernel is the essential common ground between processes, and must share out access to any resource for which processes compete (CPU time, memory, disc bandwidth etc.). It must also provide basic mechanisms so that processes which want to co-operate can communicate with each other. BSD and other Unix-like systems are traditionally rather kernel-heavy; more modern OS' try to provide only minimum functions in the kernel (which is then often called a *microkernel*), handing over other jobs to distinct “server” processes.

- *File system*: the kernel provides access to the file system, which is based on `open/read/write/close` functions. In practice this splits into two; resolving names and then implementing file I/O.

There will usually be multiple file system implementations (but each offering the same service); a file I/O system call will be redirected to the correct code according to whether the file is local, on NFS, on a DOS floppy disc, etc.

- *Scheduling*: BSD decides which process to run. Most of the time, processes will run until they need some input – and then they’ll make a system call to get the input and block until the input is ready.

But sometimes a process needs to compute for longer; in this case it will be *time-sliced*; it will be allowed to run only for a second or so and then another process will be given a go.

To prevent a compute-bound process from clogging up the CPU, processes are given priorities, and any process which uses up its time slice has its priority reduced. A priority-based scheduling decision is made often – potentially, after any interrupt.

- *Paging*: the kernel shares memory by picking pages of memory which don’t appear to have been used for a while, and throwing them out. A data page which has been written by a process since it came in must first be saved to a disc swap file.

The MIPS architecture gives no direct help in tracing what happens to pages; in many architectures the MMU hardware notes (separately) whenever a page is either referenced or written. In MIPS this must be simulated; so the kernel picks pages and marks them as (from the point of view of the hardware) “read only” or “invalid”. Then it waits; if a process references or writes the page a trap will be generated, and the trap handler will look at the page status and set a software referenced/written bit.

In this way processes which are not active slowly migrate out of memory.

- *Caching and sharing code*: it often happens, particularly in a multi-user system, that there are multiple processes all running the same program. NetBSD treats code pages (i.e. read-only pages marked as loadable from a file) as sharable; when they are kept in memory they are indexed by their disc location. During periods of relatively light load (which is most of the time in most systems) much of memory has nothing very useful in it; so code pages are allowed to stay there, forming a least-recently used cache.

This means that a program which is repeatedly re-run to completion goes much faster. Although each time a process must be created and the whole program nominally “paged in”, in practice all that is needed is to construct a set of entries referencing the already memory-resident code.

## Virtual memory implementation for MIPS

The R30xx hardware supports an arbitrary (though small) set of translations in its 64-entry TLB. When an address is encountered which doesn’t match with one of these, the CPU takes an exception (a *tlbmiss*) and software must find a new translation and load it.

“tlbmiss” events can occur very frequently when running large programs, and the trap handler must run quickly. Misses for user-mode addresses are vectored through a dedicated trap vector, to the *utlbmiss* routine; since MIPS kernels can be built to run largely in the *kseg0/kseg1* areas (which don’t require the TLB) the vast majority of TLB misses are user ones.

To speed the trap handler, most systems will keep memory-resident tables of page entries, in a format already bit-for-bit compatible with the hardware-determined TLB entries.

It would be nice to do this by keeping a simple array of TLB entries, indexed by virtual address. However, with a 2Gbyte range of user addresses and 4Kbyte pages, the array would require 512K entries,

occupying 2Mbytes of memory. Since the program address space has huge “holes” in it, most of this 2Mbytes of memory would be full of nothing – which is a lot of memory to dedicate,

Two different solutions to this problem are used. MIPS Corp’s UMIPS and RISC/os variants use a linear page table but don’t keep it all in memory; NetBSD uses a memory-held secondary cache of page table entries supporting a machine-independent data structure:

- *Linear Page table not all in memory*: the linear page table is located in the *virtual* space *kseg2*. Although the whole page table is very large, most of it is never referenced, never allocated a *kseg2* translation, and therefore costs nothing. The active parts of the page table correspond with the stack, data and code parts of the process address space; and for these the *kseg2* translation is likely to remain live.

The CPU’s *Context* register is explicitly designed to do the work of computing where the desired page table entry lies, saving a few more instructions.

This does require that the *utlbmiss* handler can safely suffer a regular trap, to cope with those occasions where the page table read falls on a *kseg2* address which is not currently translated by the TLB. This nested exception is not allowed to happen in any other circumstances; but its use here motivates another feature of the MIPS hardware, and a convention:

- a) The status register’s internal stack of processor state (2 bits for kernel/user mode and interrupt on/off) is three deep; allowing an exception to occur in an exception handler, *before* the status register gets saved.
- b) The “nested” exception overwrites the *EPC* value (return address) from the original address reference, so the *utlbmiss* handler saves *EPC* into the general-purpose register *k1*; the regular trap handler which deals with kernel TLB misses has to detect the double-exception and return to the right place.

This is why there are two registers (*k0,k1*) reserved for exception handling: most of the time only one is needed.

- *Secondary cache of page table entries*: NetBSD uses a different technique. Here the TLB miss handler consults a software cache of recently used page table entries. The software cache is implemented with a simple 2-set hashing function, with a fast path for translations which are in the same set as their predecessor. A modestly large cache gives an excellent hit rate – so those few translations which miss here can be computed by a C-language routine using architecture-independent tables.

## Interrupt handling for MIPS

Interrupt handling in Unix-like OS’ are descended from the priority-based system implemented in hardware by DEC’s PDP-11 and VAX architectures. Priorities are numbered from 0 to 7 (though not all are always used) – more recently, the numeric priorities have been getting names.

- *Priority model and spl*: kernel code is arranged so that, in general, each piece of code is accessible only at or above a particular priority level. So, for example, once a program is at level 4 the CPU will only accept interrupt requests prioritized at level 5 and above.

Most of the kernel code used by system calls runs at level 0.

Device code which needs to lock itself against asynchronously-occurring interrupt events can call a function such as *spl4()* (*spl* stands for “set processor level”): there is a separate call for each level. *spl4()* returns a value representing the priority level when it was called, so the code sequence:



```
p = spl4();
/* do something which can't be interrupted */
splx(p);
```

restores whatever is required to lower the level again.

Note that interrupt handlers can get called at two points: either as soon as the interrupt signal is activated, or (if the processor is currently at a higher spl) the handler will be called when a call to *splx()* lowers the level below the interrupt's priority.

### **How it works**

The MIPS interrupt hardware knows nothing of levels, with only an unprioritized mask for the interrupt inputs. But if an spl level can be assigned to each of the interrupt inputs, then each of the *spl.()* routines can be implemented by setting the interrupt mask to a value enabling only those interrupts allocated a higher level.



The MIPS-1 architecture found in the R30xx family is designed for high-frequency, single-cycle instruction operation. Also, as noted earlier, the MIPS architecture does not carry a status register, nor does it directly support various addressing formats. As a result, some operations that may have been found in older CISC architectures must be synthesized from multiple instructions in the MIPS architecture. The net execution time is typically improved, however, since these complex instructions were inherently multi-cycle in these older CISC architectures.

This chapter describes common programming problems and their implementation in the MIPS architecture. Many of these operations are directly supported by the synthetic instructions, described earlier.

Also note that many of these instructions require the use of \$at (the assembler temporary register) described earlier.

### **32-bit Address or Constant Values**

As noted earlier in this manual, the MIPS-1 instruction set does not have enough room in the bit encoding to directly support 32-bit constants or constant address values. Thus, programmers must use combinations of instructions to generate 32-bit values.

Again, these are commonly handled using the synthetic **la** or **li** instructions. Depending on the immediate value, the assembler will generate one or two instructions to implement the immediate load into the register:

<b>Operand</b>	<b>Instruction Sequence</b>
Upper 16 bits all zero	<i>ori rd, value<sub>15..0</sub></i>
Upper 17 bits all one	<i>addi rd, \$0, value<sub>15..0</sub></i>
Lower 16 bits all zero	<i>lui rd, value<sub>31..16</sub></i>
All other values	<i>lui rd, value<sub>15..0</sub> ori rd, value<sub>31..16</sub></i>

**Table 16.1. 32-bit immediate values**

To jump to an absolute 32-bit address, a similar construct must be used. The **la** synthetic instruction is used to load the target address into a register; a **jr** (jump register) is then used to perform the jump.

Note that **j** and **jal** may be used in many instances. However, these instructions take the high-order four bits of the current “PC” as the upper four bits of the target address, and thus limit the program space that can be reached. In practice, this limit may be larger than the address space of most typical embedded applications.

### **Use of “Set” Instructions**

The MIPS ISA provides a very powerful operation to enable the easy synthesis of complex test operations.

The “set” instructions place a value of ‘1’ (true) or ‘0’ (false) into the specified destination register to reflect the outcome of a specified comparison operation. When used with conditional branch operations, complex comparison sequences can be implemented, as well add-with-carry or subtract-with-borrow operation.

### Use of “Set” with Complex Branch Operations

The MIPS instruction set directly implements branch comparisons for the following cases:

- two registers equal
- two registers not equal
- register greater-than-or-equal to zero
- register less-than-or-equal to zero
- register greater-than zero
- register less-than zero

These branch comparisons directly implement a wide range of common test conditions directly in hardware. However, in certain situations the programmer may require a more complicated test between two non-zero registers. This is where the “set” instructions are used.

For example, if the programmer wishes to branch conditionally if one register is less than another, a two instruction sequence is used:

```
slt    $at, $a, $b
bne   $at, $0, target # branch to target if a < b
```

Using analogous instruction sequences, the programmer can synthesize virtually any comparison between two registers using the various set instructions.

Similarly, comparisons with immediate values can be implemented. For example, to compare whether a register value is less-than-or-equal to an immediate:

```
slti   $at, $a, imm+1
bne   $at, $0, target # branch to target if a <= imm
```

Of course, if the immediate value is large, then the programmer must first build it into a register as described earlier in this chapter, and then perform the comparison.

Many of these common operations are already built into the synthetic instruction set supported by a given toolchain assembler package. The programmer is advised to consult the reference manual.

### Carry, borrow, overflow, and multi-precision math

The MIPS-1 ISA does not directly support a carry bit. Instead, the effects of a carry bit can be synthesized when needed using the “set” constructs. This enables the programmer to implement tests for overflow, multi-precision math, and add-with-carry operations.

For example, these constructs enable the programmer to perform tests to determine whether an arithmetic operation resulted in a carry (or borrow).

For add sequences, there are two cases to consider:

Case	Instruction Sequence
No possible carry from previous operation	<i>addu temp, A, B</i> <i>sltu carryout, temp, B # carryout from A + B</i>
Carry-in from previous operation	<i>not temp, A</i> <i>sltu carryout, B, temp</i> <i>xor carryout, 1 # carry-out from A+B+1</i>

**Table 16.2. Add-with-carry**

Subtract with borrow works analogously:

Case	Instruction Sequence
No borrow-in	<i>sltu borrow, B, A #borrow-out from A-B</i>
Borrow-in from previous	<i>sltu borrow, B, A xor borrow, 1 #borrow out from A-B-1</i>

**Table H.3. Subtract-with-borrow operation**

Testing for overflow also uses the set instructions, coupled with two basic rules:

- An addition operation has overflowed if:
  - the sign of both operands is the same
  - the sign of the result differs from the sign of the operands
- A subtraction has overflowed if
  - the signs of the two operands are different
  - the sign of the result is different from the sign of the minuend

Testing for these conditions is a simple programming exercise. For example, testing for overflow in signed addition:

```

/* branch to Label if t1+t2 overflows                                     */
    addu      t0, t1, t2      /* result in t0*/
    xor       t3, t1, t2      /* check signs of operands*/
    bltz      t3, 1f          /* then no overflow*/

    xor       t3, t0, t1      /* check sign of result */
    bltz      t3, Label      /* overflow...*/

1f:          /* no overflow */

```

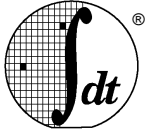

Integrated Device Technology, Inc.

## MACHINE INSTRUCTIONS REFERENCE

## APPENDIX A

### CPU Instruction Overview

This appendix provides a detailed description of the operation of each user mode CPU Instruction for the MIPS I architecture. The instructions are listed in alphabetical order.

Exceptions that may occur due to the execution of each instruction are listed after the description of each instruction. Descriptions of the immediate cause and manner of handling exceptions are omitted from the instruction descriptions in this appendix.

### Instruction Classes

CPU instructions are divided into the following classes:

- **Load and Store** instructions move data between memory and general registers. They are all I-type instructions, since the only addressing mode supported for the general registers is *base register + 16-bit immediate offset*.
- **Computational** instructions perform arithmetic, logical and shift operations on values in registers. They occur in both R-type (both operands are registers) and I-type (one operand is a 16-bit immediate) formats.
- **Jump and Branch** instructions change the control flow of a program. Jumps are always made to absolute 26-bit word addresses (J-type format), or register addresses (R-type), for returns and dispatches. Branches have 16-bit offsets relative to the program counter (I-type). **Jump and Link** instructions save their return address in register 31.
- **Coprocessor** instructions perform operations in the coprocessors. Coprocessors have up to two register sets separate from the CPU. Coprocessor loads and stores, similar to those for the general registers, are defined for the coprocessors and are I-type. Coprocessor computational instructions have coprocessor-dependent formats.
- **Special** instructions perform a variety of tasks, including movement of data between special and general registers, trap, and breakpoint. They are always R-type.

## Instruction Formats

Every CPU instruction consists of a single word (32 bits) aligned on a word boundary and the major instruction formats are shown in Figure A.1.:

I-Type (Immediate)

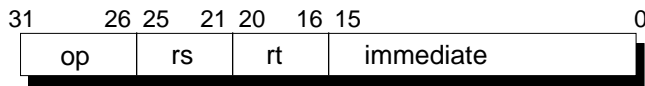

J-Type (Jump)

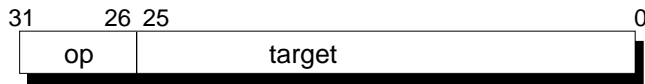

R-Type (Register)

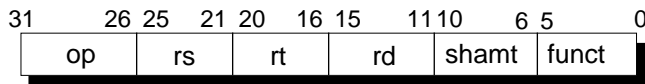

op	6-bit operation code
rs	5-bit source register specifier
rt	5-bit target (source/destination) or branch condition
immediate	16-bit immediate, branch displacement or address displacement
target	26-bit jump target address
rd	5-bit destination register specifier
shamt	5-bit shift amount
funct	6-bit function field

**Figure A.1: CPU Instruction Formats**

## Instruction Notation Conventions

In this appendix, all variable subfields in an instruction format (such as *rs*, *rt*, *immediate*, etc.) are shown in lowercase names.

For the sake of clarity, an alias is sometimes used for a variable subfield in the formats of specific instructions. For example, *rs = base* is used in the format for load and store instructions. Such an alias is always lower case, since it refers to a variable subfield.

In the instruction descriptions that follow, the *Operation* section describes the operation performed by each instruction using a high-level language notation.

Special symbols used in the notation are described below.

Symbol	Meaning
$\leftarrow$	Assignment.
$\parallel$	Bit string concatenation.
$x^y$	Replication of bit value $x$ into a $y$ -bit string. Note: $x$ is always a single-bit value.
$x_{y..z}$	Selection of bits $y$ through $z$ of bit string $x$ . Little-endian bit notation is always used. If $y$ is less than $z$ , this expression is an empty (zero length) bit string.
$+ - *$	2's complement or floating-point arithmetic: addition, subtraction, multiplication.
div	2's complement integer division.
mod	2's complement modulo.
/	Floating-point division.
<	2's complement less than comparison.
nor	Bit-wise logical NOR.
xor	Bit-wise logical XOR.
and	Bit-wise logical AND.
or	Bit-wise logical OR.
GPRlen	The length, in bits (32for MIPS-I), of the CPU General Purpose Registers)
GPR[ $x$ ]	General-Register $x$ . The content of GPR[0] is always zero. Attempts to alter the content of GPR[0] have no effect.
FCC[ $cc$ ]	Floating-Point condition code $cc$ . FCC[0] has the same value as COC[1].
CPR[ $z,x$ ]	Coprocessor unit $z$ , general register $x$ .
CCR[ $z,x$ ]	Coprocessor unit $z$ , control register $x$ .
COC[ $z$ ]	Coprocessor unit $z$ condition signal.
BigEndianMem	Big-endian mode as configured at reset (0 $\rightarrow$ Little, 1 $\rightarrow$ Big). Specifies the endianness of the memory interface (see LoadMemory and StoreMemory), and the endianness of Kernel and Supervisor mode execution.
ReverseEndian	Signal to reverse the endianness of load and store instructions. This feature is available in User mode only, and is effected by setting the <i>RE</i> bit of the <i>Status</i> register. Thus, ReverseEndian may be computed as (SR <sub>25</sub> and User mode).
BigEndianCPU	The endianness for load and store instructions (0 $\rightarrow$ Little, 1 $\rightarrow$ Big). In User mode, this endianness may be reversed by setting SR <sub>25</sub> . Thus, BigEndianCPU may be computed as BigEndianMem XOR ReverseEndian.
LLbit	Only valid for MIPS-II instructions.
T+ $i$ :	Indicates the time steps between operations. Each of the statements within a time step are defined to be executed in sequential order (as modified by conditional and loop constructs). Operations which are marked T+ $i$ : are executed at instruction cycle $i$ relative to the start of execution of the instruction. Thus, an instruction which starts at time $j$ executes operations marked T+ $i$ : at time $i + j$ . The interpretation of the order of execution between two instructions or two operations which execute at the same time should be pessimistic; the order is not defined.

Table A.4: CPU Instruction Operation Notations

### Instruction Notation Examples

The following examples illustrate the application of some of the instruction notation conventions:

Example #1:

$$\text{GPR}[rt] \leftarrow \text{immediate} \parallel 0^{16}$$

Sixteen zero bits are concatenated with an immediate value (typically 16 bits), and the 32-bit string (with the lower 16 bits set to zero) is assigned to General-Purpose Register *rt*.

Example #2:

$$(\text{immediate}_{15})^{16} \parallel \text{immediate}_{15\dots 0}$$

Bit 15 (the sign bit) of an immediate value is extended for 16 bit positions, and the result is concatenated with bits 15 through 0 of the immediate value to form a 32-bit sign extended value.

## Load and Store Instructions

In R30xx family processors all loads are implemented with a delay of one instruction. The instruction immediately following a load may not use the destination register of the load instruction; at least one instruction must come between load and use. The hardware does not enforce this restriction nor detect a failure to follow it. One exception to the load delay is that Load Word Right and Load Word Left may specify a destination register that is the same register used as the destination of an immediately preceding load. This allows a LWL, LWR pair without intervening instructions. The regular I-type load and store instructions use *base\_register+offset* addressing. In the load and store descriptions, the functions listed below are used to summarize the handling of virtual addresses and physical memory.

Function	Meaning
AddressTranslation	Determines the physical address given the virtual address. The function fails and an exception is taken if the required translation is not present in the TLB ("E" parts only).
LoadMemory	Uses the cache and main memory to find the contents of the word containing the specified physical address. The low-order two bits of the address and the <i>Access Type</i> field indicates which of each of the four bytes within the data word need to be returned. If the cache is enabled for this access, the entire word is returned and loaded into the cache.
StoreMemory	Uses the cache, write buffer, and main memory to store the word or part of word specified as data in the word containing the specified physical address. The low-order two bits of the address and the <i>Access Type</i> field indicates which of each of the four bytes within the data word should be stored.

**Table A.5: Load and Store Common Function**

As shown below, the *Access Type* field indicates the size of the data item to be loaded or stored. Regardless of access type or byte-numbering order (endianness), the address specifies the byte which has the smallest byte



address in the addressed field. For a big-endian machine, this is the leftmost byte and contains the sign for a 2's complement number; for a little-endian machine, this is the rightmost byte. Note for R30xx CPUs, the only sizes valid are word and smaller.s

Access Type Mnemonic	Value	Meaning
DOUBLEWORD	7	8 bytes (64 bits)
SEPTIBYTE	6	7 bytes (56 bits)
SEXTIBYTE	5	6 bytes (48 bits)
QUINTIBYTE	4	5 bytes (40 bits)
WORD	3	4 bytes (32 bits)
TRIPLEBYTE	2	3 bytes (24 bits)
HALFWORD	1	2 bytes (16 bits)
BYTE	0	1 byte (8 bits)

**Table A.6: Access Type Specifications for Loads/Store**

The bytes within the addressed doubleword which are used can be determined directly from the access type and the three low-order bits of the address.

### Jump and Branch Instructions

All jump and branch instructions have an architectural delay of exactly one instruction. That is, the instruction immediately following a jump or branch (that is, occupying the delay slot) is always executed while the target instruction is being fetched from storage. A delay slot may not itself be occupied by a jump or branch instruction; however, this error is not detected and the results of such an operation are undefined.

If an exception or interrupt prevents the completion of a legal instruction during a ranch delay slot, the hardware sets the *EPC* register to point at the jump or branch instruction and an indication that the exception was caused by the instruction in the delay slot. To continue the instruction stream and re-execute the instruction that faulted, both the jump or branch instruction and the instruction in the delay slot are reexecuted.

Because jump and branch instructions may be restarted after exceptions or interrupts, they must be restartable. Therefore, when a jump or branch instruction stores a return link value, register 31 (the register in which the link is stored) may not be used as a source register.

Since instructions must be word-aligned, a **Jump Register** or **Jump and Link Register** instruction must use a register containing a valid word address. If the two low-order bits are not zero, an address exception will occur when the jump target instruction is subsequently fetched.

### Coprocessor Instructions

Coprocessors are alternate execution units, which have register files separate from the CPU. The MIPS architecture provides a uniform abstraction for a few coprocessor units, some of which are implemented in any particular processor. The coprocessors may have two register spaces, each space containing up to thirty-two registers. Coprocessor computational instructions may alter registers in either space.

- The first space, *coprocessor general* registers, may be directly loaded from memory and stored into memory, and their contents may be transferred between the coprocessor and processor general registers.
- The second space, *coprocessor control* registers, may only have their contents transferred directly between the coprocessor and the processor general registers.

System control for all MIPS processors is implemented as Coprocessor 0 (CP0) – the System Control Coprocessor. It provides the processor control, memory management, and exception handling functions. The CP0 instructions are specific to each CPU and are documented with the CPU-specific information.

If a system includes a Floating Point Unit for floating-point computation, it is implemented as Coprocessor 1 (CP1). The FPU instructions are documented in Appendix B.

### **System Control Coprocessor (CP0) Instructions**

There are some special limitations imposed on operations involving CP0 that is incorporated within the CPU. Load and store instructions are not valid for CP0 registers; the move to/from coprocessor instructions are the only valid mechanism for writing to and reading from the CP0 registers.

### **Instruct Set Details**

The following pages contain an alphabetical listing of the CPU instructions for the R30xx family.

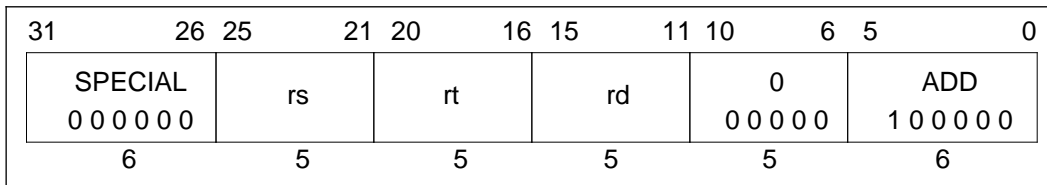
**ADD****Add Word****ADD****Format:**

ADD rd, rs, rt

**Purpose:**

Add two 32-bit values and produce a 32-bit result; arithmetic overflow causes an exception.

**Description:**

The word value in general register *rt* is added to the word value in general register *rs* and the result word value is placed into general register *rd*. If the addition results in 32-bit 2's complement arithmetic overflow (carries out of bits 30 and 31 differ) then the destination register *rd* is not modified and an integer overflow exception occurs.

**Operation:**

T: $\text{GPR}[\text{rd}] \leftarrow \text{GPR}[\text{rs}] + \text{GPR}[\text{rt}]$
---

**Exceptions:**

Integer overflow exception

# ADDI                      Add Immediate Word                      ADDI

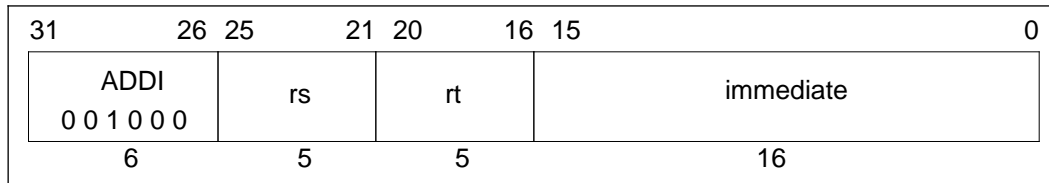
**Format:**

ADDI *rt*, *rs*, *immediate*

**Description:**

The 16-bit *immediate* is sign-extended and added to the contents of general register *rs* to form the result. The result is placed into general register *rt*.

An overflow exception occurs if carries out of bits 30 and 31 differ (2's complement overflow). The destination register *rt* is not modified when an integer overflow exception occurs.

**Operation:**

$$T: \quad \text{GPR}[rt] \leftarrow \text{GPR}[rs] + (\text{immediate}_{15})^{16} // \text{immediate}_{15..0}$$

**Exceptions:**

Integer overflow exception

# ADDIU      Add Immediate Unsigned Word      ADDIU

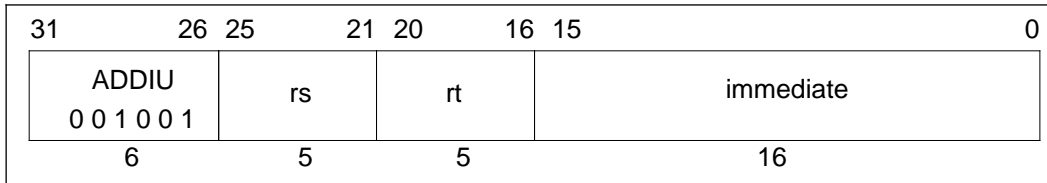
**Format:**

ADDIU rt, rs, immediate

**Description:**

The 16-bit *immediate* is sign-extended and added to the contents of general register *rs* to form the result. The result is placed into general register *rt*. No integer overflow exception occurs under any circumstances.

The only difference between this instruction and the ADDI instruction is that ADDIU never causes an overflow exception.

**Operation:**

```

T:  temp ← GPR[rs] + (immediate15)48 // immediate15...0
    if 32-bit-overflow (temp) then
        GPR[rt] ← (temp31)32 || temp31...0
    else
        GPR[rt] ← temp

```

**Exceptions:**

None

# ADDU                      Add Unsigned Word                      ADDU

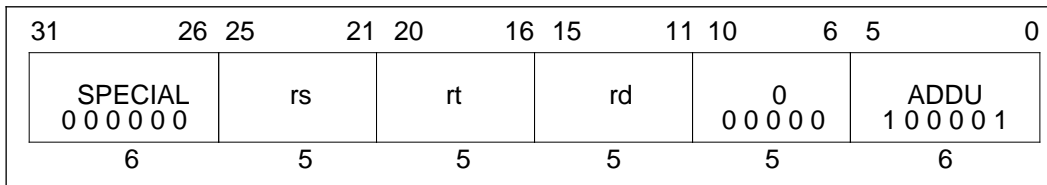

## Format:

ADDU rd, rs, rt

## Description:

Add two 32-bit values and produce a 32-bit result; arithmetic overflow is ignored (does not cause an exception).

The word value in general register *rt* is added to the word value in general register *rs* and the result word value is placed into general register *rd*. ADDU differs from ADD only when an arithmetic overflow occurs. If the addition results in 32-bit 2's complement overflow (carries out of bits 30 and 31 differ), the result word value is placed into register *rd* and no exception occurs.

## Operation:

T: $\text{GPR}[\text{rd}] \leftarrow \text{GPR}[\text{rs}] + \text{GPR}[\text{rt}]$
---

## Exceptions:

None

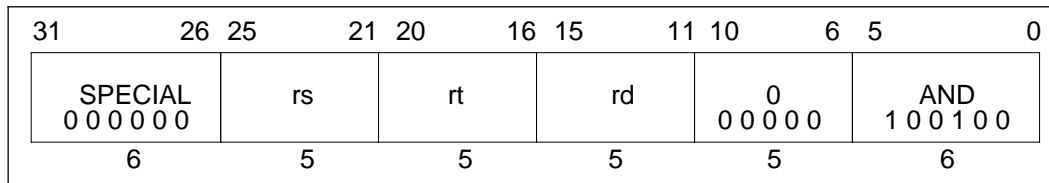
**AND****And****AND****Format:**

AND rd, rs, rt

**Description:**

The contents of general register *rs* are combined with the contents of general register *rt* in a bit-wise logical AND operation. The result is placed into general register *rd*.

**Operation:**

T:   GPR[rd] ← GPR[rs] and GPR[rt]
------------------------------------

**Exceptions:**

None

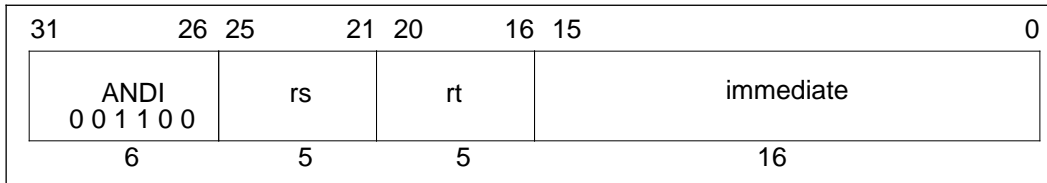
**ANDI****And Immediate****ANDI****Format:**

ANDI rt, rs, immediate

**Description:**

The 16-bit *immediate* is zero-extended and combined with the contents of general register *rs* in a bit-wise logical AND operation. The result is placed into general register *rt*.

**Operation:**

$$T: \text{ GPR}[rt] \leftarrow 0^{16} \parallel (\text{immediate and GPR}[rs]_{15..0})$$
**Exceptions:**

None

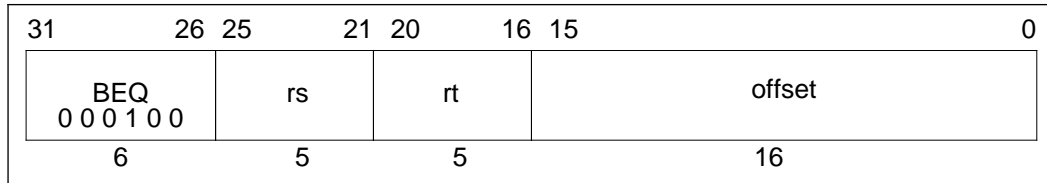

# BEQ                      Branch On Equal                      BEQ

**Format:**

BEQ rs, rt, offset

**Description:**

A branch target address is computed from the sum of the address of the instruction in the delay slot and the 16-bit *offset*, shifted left two bits and sign-extended. The contents of general register *rs* and the contents of general register *rt* are compared. If the two registers are equal, then the program branches to the target address, with a delay of one instruction.

**Operation:**

```

T:   target ← (offset15)14 || offset || 02
      condition ← (GPR[rs] = GPR[rt])
T+1: if condition then
      PC ← PC + target
      endif
  
```

**Exceptions:**

None

# BGEZ                      Branch On Greater Than Or Equal To Zero                      BGEZ

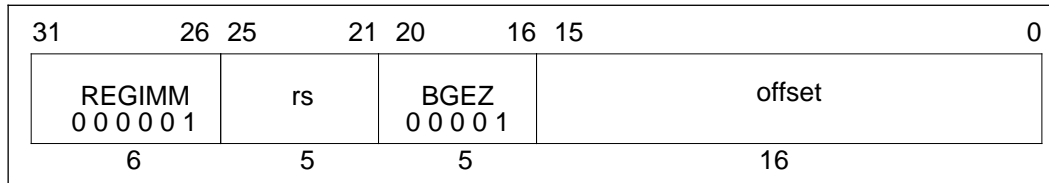
**Format:**

BGEZ rs, offset

**Description:**

A branch target address is computed from the sum of the address of the instruction in the delay slot and the 16-bit *offset*, shifted left two bits and sign-extended. If the contents of general register *rs* have the sign bit cleared, then the program branches to the target address, with a delay of one instruction.

**Operation:**

T:     $\text{target} \leftarrow (\text{offset}_{15})^{14} \parallel \text{offset} \parallel 0^2$   
        $\text{condition} \leftarrow (\text{GPR}[\text{rs}]_{31} = 0)$

T+1: if condition then  
       PC  $\leftarrow$  PC + target

      endif

**Exceptions:**

None

# BGEZAL      Branch On Greater Than Or Equal To Zero And Link      BGEZAL

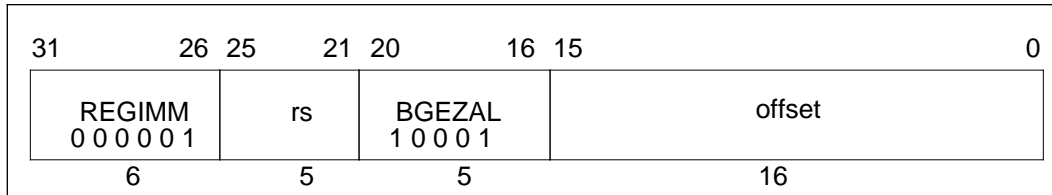

## Format:

BGEZAL rs, offset

## Description:

A branch target address is computed from the sum of the address of the instruction in the delay slot and the 16-bit *offset*, shifted left two bits and sign-extended. Unconditionally, the address of the instruction after the delay slot is placed in the link register, *r31*. If the contents of general register *rs* have the sign bit cleared, then the program branches to the target address, with a delay of one instruction.

General register *rs* may not be general register *31*, because such an instruction is not restartable. An attempt to execute this instruction is not trapped, however.

## Operation:

```

T:  target ← (offset15)14 || offset || 02
     condition ← (GPR[rs]31 = 0)
     GPR[31] ← PC + 8
T+1: if condition then
      PC ← PC + target
     endif

```

## Exceptions:

None

# BGTZ Branch On Greater Than Zero BGTZ

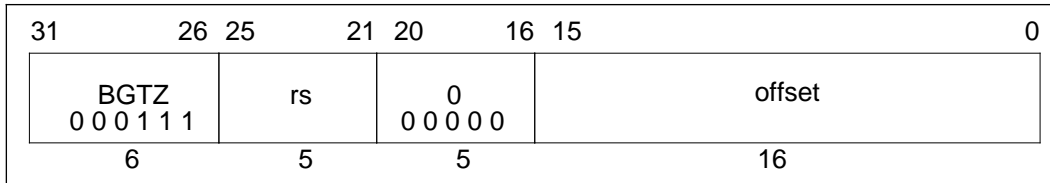

## Format:

BGTZ rs, offset

## Description:

A branch target address is computed from the sum of the address of the instruction in the delay slot and the 16-bit *offset*, shifted left two bits and sign-extended. The contents of general register *rs* are compared to zero. If the contents of general register *rs* have the sign bit cleared and are not equal to zero, then the program branches to the target address, with a delay of one instruction.

## Operation:

T:   target  $\leftarrow$  (offset<sub>15</sub>)<sup>14</sup> || offset || 0<sup>2</sup>  
       condition  $\leftarrow$  (GPR[rs]<sub>31</sub> = 0) and (GPR[rs]  $\neq$  0<sup>32</sup>)

T+1: if condition then  
       PC  $\leftarrow$  PC + target  
       endif

## Exceptions:

None

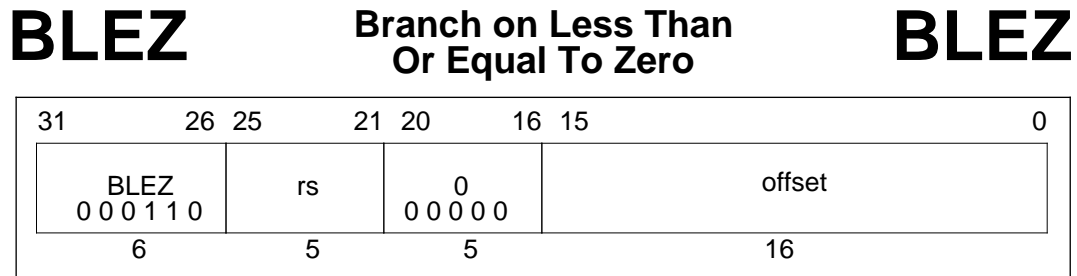
**Format:**

BLEZ rs, offset

**Description:**

A branch target address is computed from the sum of the address of the instruction in the delay slot and the 16-bit *offset*, shifted left two bits and sign-extended. The contents of general register *rs* are compared to zero. If the contents of general register *rs* have the sign bit set, or are equal to zero, then the program branches to the target address, with a delay of one instruction.

**Operation:**

```

T:   target ← (offset15)14 || offset || 02
      condition ← (GPR[rs]31 = 1) or (GPR[rs] = 032)
T+1: if condition then
      PC ← PC + target
      endif

```

**Exceptions:**

None

# BLTZ Branch On Less Than Zero BLTZ

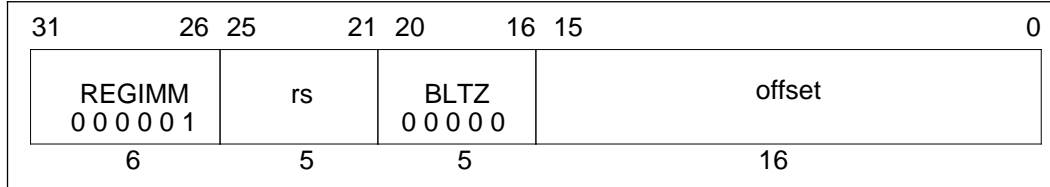
**Format:**

BLTZ rs, offset

**Description:**

A branch target address is computed from the sum of the address of the instruction in the delay slot and the 16-bit *offset*, shifted left two bits and sign-extended. If the contents of general register *rs* have the sign bit set, then the program branches to the target address, with a delay of one instruction.

**Operation:**

T:   target  $\leftarrow$  (offset<sub>15</sub>)<sup>14</sup> || offset || 0<sup>2</sup>  
       condition  $\leftarrow$  (GPR[rs]<sub>31</sub> = 1)  
 T+1: if condition then  
       PC  $\leftarrow$  PC + target  
       endif

**Exceptions:**

None

# BLTZAL      Branch On Less Than Zero And Link      BLTZAL

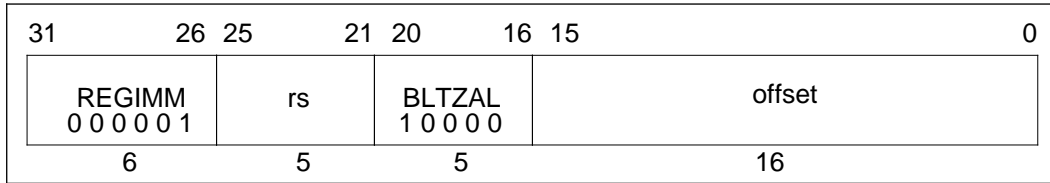
**Format:**BLTZAL *rs*, *offset***Description:**

A branch target address is computed from the sum of the address of the instruction in the delay slot and the 16-bit *offset*, shifted left two bits and sign-extended. Unconditionally, the address of the instruction after the delay slot is placed in the link register, *r31*. If the contents of general register *rs* have the sign bit set, then the program branches to the target address, with a delay of one instruction.

General register *rs* may not be general register *31*, because such an instruction is not restartable. An attempt to execute this instruction with register *31* specified as *rs* is not trapped, however.

**Operation:**

```

T:   target ← (offset15)14 || offset || 02
      condition ← (GPR[rs]31 = 1)
      GPR[31] ← PC + 8
T+1: if condition then
      PC ← PC + target
      endif

```

**Exceptions:**

None

# BNE                      Branch On Not Equal                      BNE

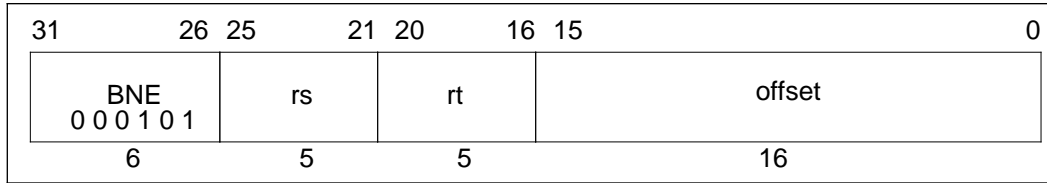
**Format:**BNE *rs*, *rt*, *offset***Description:**

A branch target address is computed from the sum of the address of the instruction in the delay slot and the 16-bit *offset*, shifted left two bits and sign-extended. The contents of general register *rs* and the contents of general register *rt* are compared. If the two registers are not equal, then the program branches to the target address, with a delay of one instruction.

**Operation:**

T:     $\text{target} \leftarrow (\text{offset}_{15})^{14} \parallel \text{offset} \parallel 0^2$   
        $\text{condition} \leftarrow (\text{GPR}[\text{rs}] \neq \text{GPR}[\text{rt}])$   
 T+1: if condition then  
        $\text{PC} \leftarrow \text{PC} + \text{target}$

**Exceptions:**

None

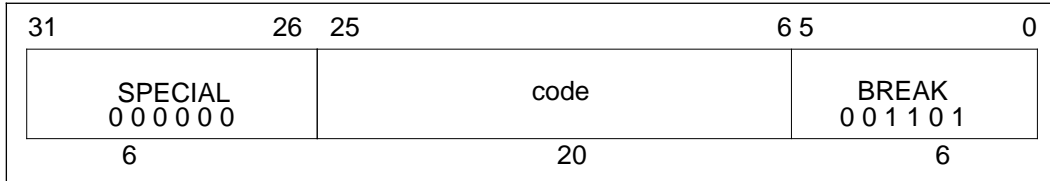

# BREAK Breakpoint BREAK

**Format:**

BREAK

**Description:**

A breakpoint trap occurs, immediately and unconditionally transferring control to the exception handler.

The *code* field is available for use as software parameters, but is retrieved by the exception handler only by loading the contents of the memory word containing the instruction.

**Operation:**

T: BreakpointException
------------------------

**Exceptions:**

Breakpoint exception

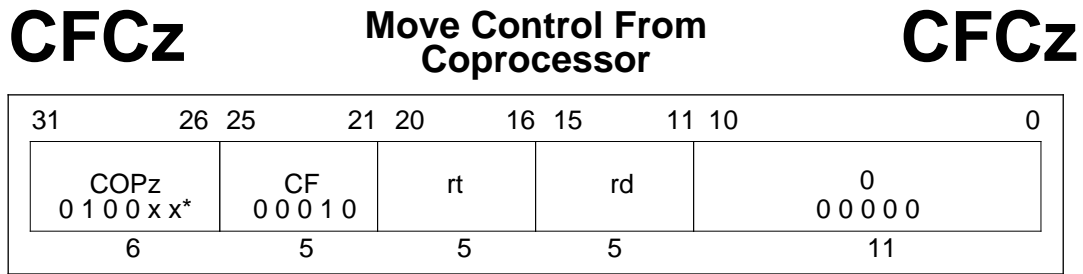
**Format:**

CFCz rt, rd

**Description:**

The contents of coprocessor control register *rd* of coprocessor unit *z* are loaded into general register *rt*.

This instruction is not valid for CP0.

**Operation:**

T: data ← CCR[z,rd]  
T+1: GPR[rt] ← data

**Exceptions:**

Coprocessor unusable exception

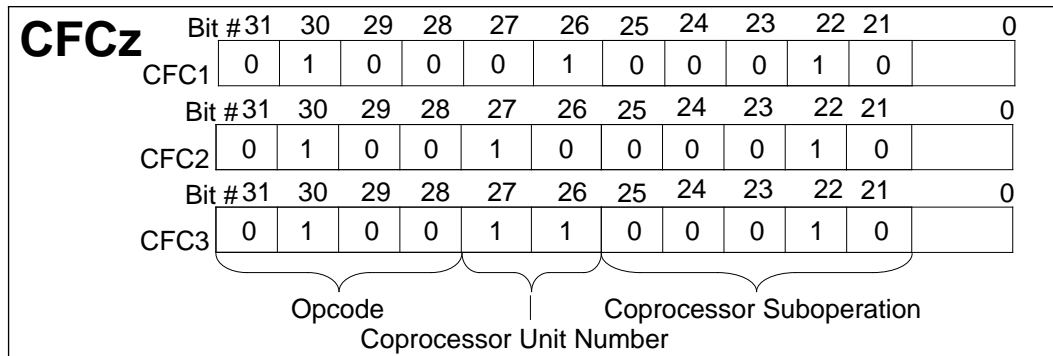
**\*Opcode Bit Encoding:**

# COPz Coprocessor Operation COPz

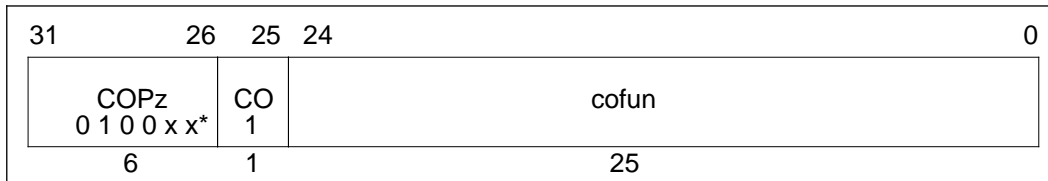

**Format:**

COPz cofun

**Description:**

A coprocessor operation is performed. The operation may specify and reference internal coprocessor registers, and may change the state of the coprocessor condition line, but does not modify state within the processor or the cache/memory system. Details of coprocessor operations are contained in other appendices.

**Operation:**

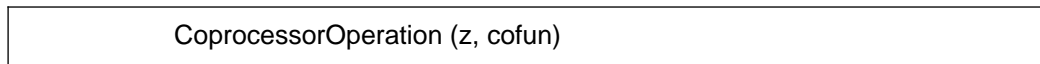

**Exceptions:**

- Coprocessor unusable exception
- Coprocessor interrupt or Floating-Point Exception (CP1 only for some processors)

**\*Opcode Bit Encoding:**

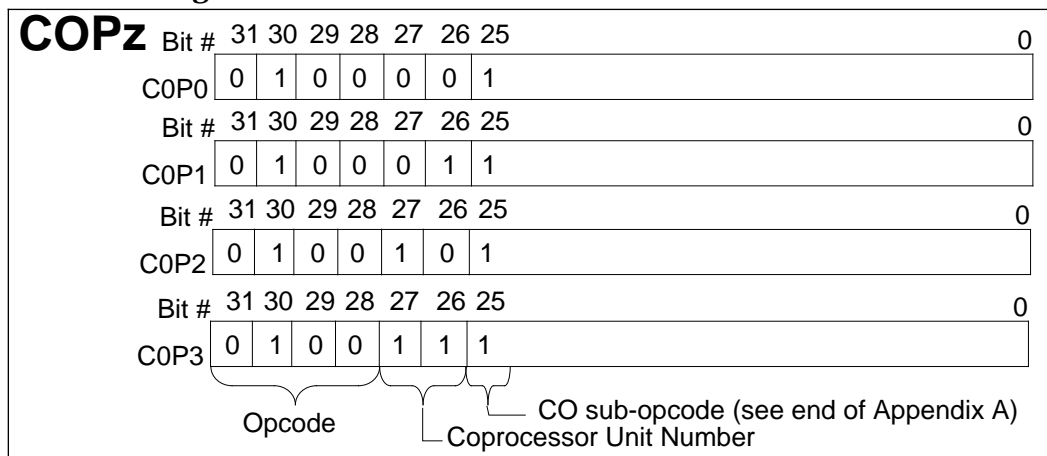

# CTCz      Move Control to Coprocessor      CTCz

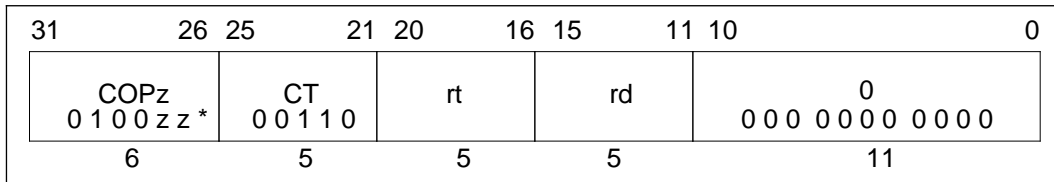
**Format:**

CTCz rt, rd

**Description:**

The contents of general register *rt* are loaded into control register *rd* of coprocessor unit *z*.

This instruction is not valid for CP0.

**Operation:**

T:     data ← GPR[rt] T + 1: CCR[z,rd] ← data
--

**Exceptions:**

Coprocessor unusable

# DIV Divide Word DIV

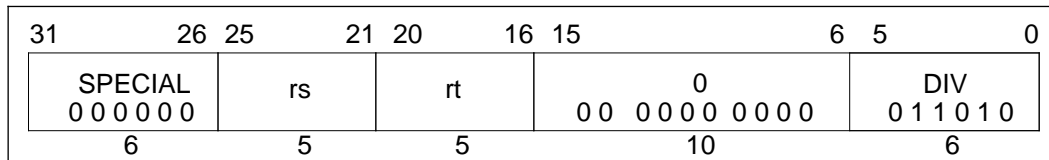
**Format:**DIV *rs*, *rt***Description:**

The contents of general register *rs* are divided by the contents of general register *rt*, treating both operands as 2's complement values. No overflow exception occurs under any circumstances, and the result of this operation is undefined when the divisor is zero.

This instruction is typically followed by additional instructions to check for a zero divisor and for overflow.

When the operation completes, the quotient word of the double result is loaded into special register *LO*, and the remainder word of the double result is loaded into special register *HI*.

If either of the two preceding instructions is MFHI or MFLO, the results of those instructions are undefined. Correct operation requires separating reads of *HI* or *LO* from writes by two or more instructions.

**DIV****Divide Word (Continued)****DIV****Operation:**

T-2:	LO	← undefined
	HI	← undefined
T-1:	LO	← undefined
	HI	← undefined
T:	LO	← $GPR[rs] \div GPR[rt]$
	HI	← $GPR[rs] \bmod GPR[rt]$

**Exceptions:**

None

# DIVU                      Divide Unsigned Word                      DIVU

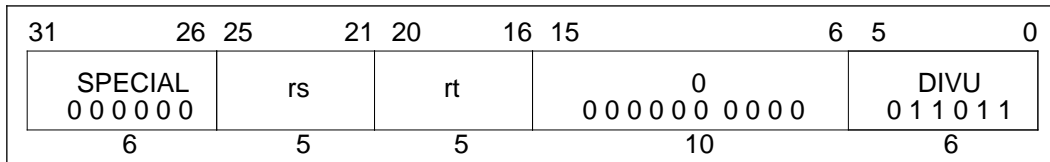
**Format:**

DIVU rs, rt

**Description:**

The contents of general register *rs* are divided by the contents of general register *rt*, treating both operands as unsigned values. No integer overflow exception occurs under any circumstances, and the result of this operation is undefined when the divisor is zero.

On processors with 64-bit registers the operands must be valid sign-extended 32-bit values. If they are not, the result is undefined.

This instruction is typically followed by additional instructions to check for a zero divisor.

When the operation completes, the quotient word of the double result is loaded into special register *LO*, and the remainder word of the double result is loaded into special register *HI*.

If either of the two preceding instructions is MFHI or MFLO, the results of those instructions are undefined. Correct operation requires separating reads of *HI* or *LO* from writes by two or more instructions.

**Operation:**

T-2:	LO	← undefined
	HI	← undefined
T-1:	LO	← undefined
	HI	← undefined
T:	LO	← (0    GPR[rs]) div (0    GPR[rt])
	HI	← (0    GPR[rs]) mod (0    GPR[rt])

**Exceptions:**

None



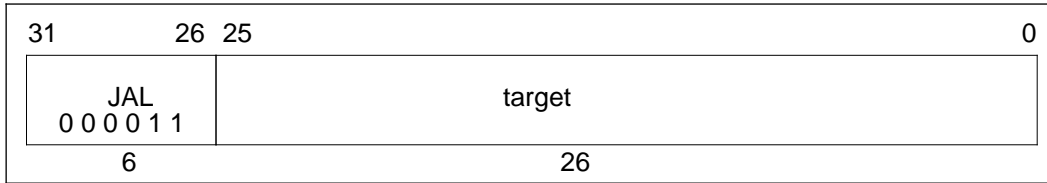

# JAL                      Jump And Link                      JAL

**Format:**

JAL target

**Description:**

The 26-bit target address is shifted left two bits and combined with the high-order bits of the address of the delay slot. The program unconditionally jumps to this calculated address with a delay of one instruction. The address of the instruction after the delay slot is placed in the link register, *r31*.

**Operation:**

T:    temp ← target  
       GPR[31] ← PC + 8  
 T+1: PC ← PC<sub>31...28</sub> || temp || 0<sup>2</sup>

**Exceptions:**

None

# JALR                      Jump And Link Register                      JALR

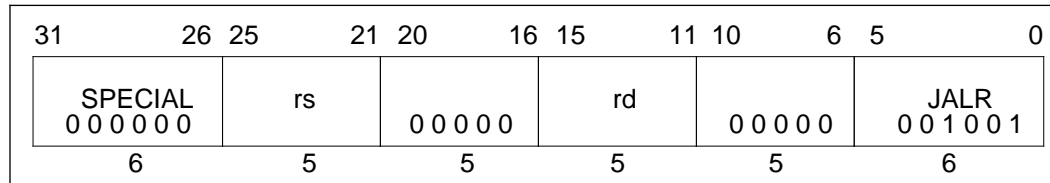
**Format:**

JALR rs  
JALR rd, rs

**Description:**

The program unconditionally jumps to the address contained in general register *rs*, with a delay of one instruction. The address of the instruction after the delay slot is placed in general register *rd*. The default value of *rd*, if omitted in the assembly language instruction, is 31.

Register specifiers *rs* and *rd* may not be equal, because such an instruction does not have the same effect when re-executed. However, an attempt to execute this instruction is *not* trapped, and the result of executing such an instruction is undefined.

A Jump and Link Register instruction that uses a register whose low-order 2 bits are non-zero, or specifies an address outside of the accessible address space, causes an Address Error Exception when the jump is executed. The Exception PC points to the location of the Jump instruction causing the error, and the instruction in the delay slot is not executed. If desired, system software can emulate the delay instruction and advance the PC to the target of the jump before delivering the exception to the user program.

**Operation:**

T:	temp ← GPR [rs] GPR[rd] ← PC + 8
T+1:	PC ← PC + target

**Exceptions:**

Address error exception

# JR    Jump Register    JR

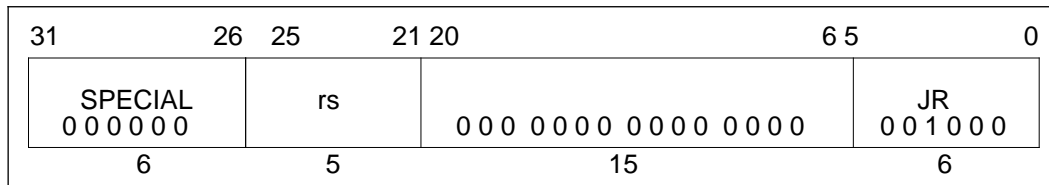
**Format:**

JR rs

**Description:**

The program unconditionally jumps to the address contained in general register *rs*, with a delay of one instruction.

Since instructions must be word-aligned, a **Jump Register** instruction must specify a target register (*rs*) whose two low-order bits are zero. If these low-order bits are not zero, an address exception will occur when the jump target instruction is subsequently fetched.

**Operation:**

<table style="width: 100%; border: none;"> <tr> <td style="padding-right: 20px;">T:</td> <td>temp ← GPR[rs]</td> </tr> <tr> <td>T+1:</td> <td>PC ← PC + target</td> </tr> </table>	T:	temp ← GPR[rs]	T+1:	PC ← PC + target
T:	temp ← GPR[rs]			
T+1:	PC ← PC + target			

**Exceptions:**

Address error exception

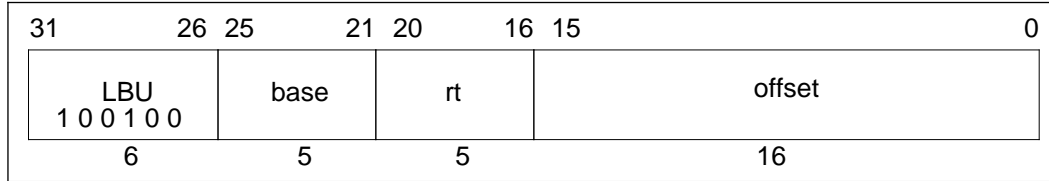

# LBU                      Load Byte Unsigned                      LBU

**Format:**LBU *rt*, offset(*base*)**Description:**

The 16-bit *offset* is sign-extended and added to the contents of general register *base* to form a virtual address. The contents of the byte at the memory location specified by the effective address are zero-extended and loaded into general register *rt*.

**Operation:**

T:      $vAddr \leftarrow ((offset_{15})^{16} \parallel offset_{15...0}) + GPR[base]$   
         $(pAddr, uncached) \leftarrow AddressTranslation(vAddr, DATA)$   
         $pAddr \leftarrow pAddr_{P\_SIZE-1...2} \parallel (pAddr_{1...0} \text{ xor } ReverseEndian^2)$   
         $mem \leftarrow LoadMemory(uncached, BYTE, pAddr, vAddr, DATA)$   
         $byte \leftarrow vAddr_{1...0} \text{ xor } BigEndianCPU^2$   
        T+1:  $GPR[rt] \leftarrow 0^{24} \parallel mem_{7+8*byte...8*byte}$

**Exceptions:**

- TLB refill exception
- TLB invalid exception
- Bus error exception
- Address error exception

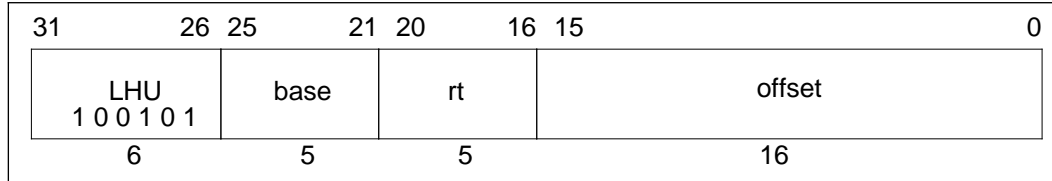

# LHU                      Load Halfword Unsigned                      LHU

**Format:**

LHU *rt*, offset(*base*)

**Description:**

The 16-bit *offset* is sign-extended and added to the contents of general register *base* to form a virtual address. The contents of the halfword at the memory location specified by the effective address are zero-extended and loaded into general register *rt*.

If the least-significant bit of the effective address is non-zero, an address error exception occurs.

**Operation:**

T:  $vAddr \leftarrow ((offset_{15})^{16} \parallel offset_{15...0}) + GPR[base]$   
 $(pAddr, uncached) \leftarrow AddressTranslation(vAddr, DATA)$   
 $pAddr \leftarrow pAddr_{PSIZE-1...2} \parallel (pAddr_{1...0} \text{ xor } (ReverseEndian \parallel 0))$   
 $mem \leftarrow LoadMemory(uncached, HALFWORD, pAddr, vAddr, DATA)$   
 $byte \leftarrow vAddr_{1...0} \text{ xor } (BigEndianCPU \parallel 0)$   
 T+1:  $GPR[rt] \leftarrow 0^{16} \parallel mem_{15+8*byte...8*byte}$

**Exceptions:**

TLB refill exception  
 Bus Error exception

TLB invalid exception  
 Address error exception

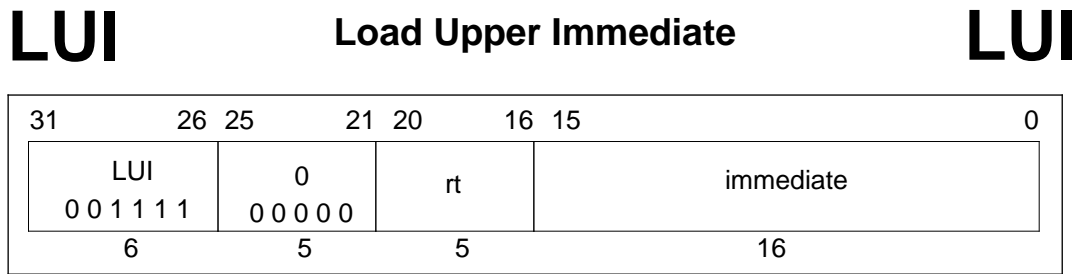
**Format:**LUI *rt*, *immediate***Description:**

The 16-bit *immediate* is shifted left 16 bits and concatenated with 16 bits of low-order zeros. The 32-bit result is then placed into general register *rt*. If *rt* is a 64-bit register, then the result is sign extended.

**Operation:**

$$\text{GPR}[rt] \leftarrow \text{immediate} \parallel 0^{16}$$

**Exceptions:**

None

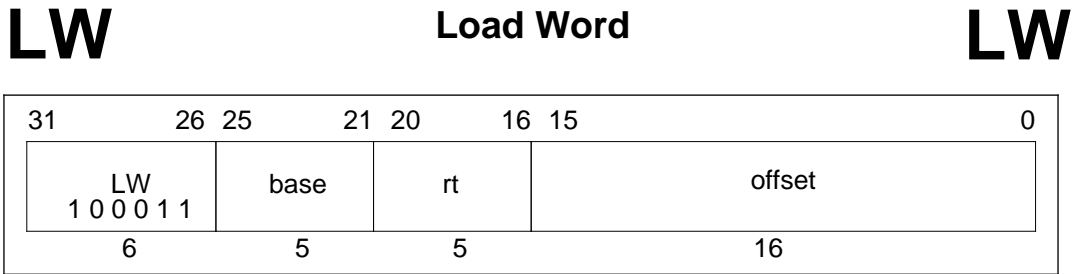

**Format:**LW *rt*, *offset*(*base*)**Description:**

The 16-bit *offset* is sign-extended and added to the contents of general register *base* to form a virtual address. The contents of the word at the memory location specified by the effective address are loaded into general register *rt*. In 64-bit mode, the loaded word is sign-extended.

If either of the two least-significant bits of the effective address is non-zero, an address error exception occurs.

**Operation:**

```

T:   vAddr ← ((offset15)16 || offset15...0) + GPR[base]
      (pAddr, uncached) ← AddressTranslation (vAddr, DATA)
      mem ← LoadMemory (uncached, WORD, pAddr, vAddr, DATA)
T+1: GPR[rt] ← mem

```

**Exceptions:**

- TLB refill exception
- TLB invalid exception
- Bus error exception
- Address error exception

# LWCz      Load Word To Coprocessor      LWCz

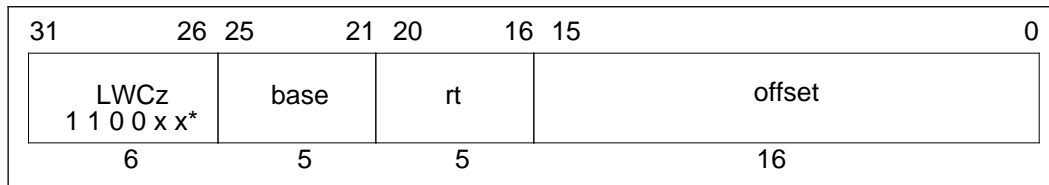

## Format:

LWCz rt, offset(base)

## Description:

The 16-bit *offset* is sign-extended and added to the contents of general register *base* to form a virtual address. The processor reads a word from the addressed memory location, and makes the data available to coprocessor unit *z*.

The manner in which each coprocessor uses the data is defined by the individual coprocessor specifications.

If either of the two least-significant bits of the effective address is non-zero, an address error exception occurs.

This instruction is not valid for use with CP0.

# LWCz      Load Word To Coprocessor (continued)      LWCz

## Operation:

T:     $vAddr \leftarrow ((offset_{15})^{16} \parallel offset_{15..0}) + GPR[base]$   
        $(pAddr, uncached) \leftarrow AddressTranslation(vAddr, DATA)$   
        $byte \leftarrow vAddr_{1..0}$   
        $mem \leftarrow LoadMemory(uncached, DOUBLEWORD, pAddr, vAddr, DATA)$   
 T+1: COPzLW (rt, mem)

## Exceptions:

- TLB refill exception
- TLB invalid exception
- Bus error exception
- Address error exception
- Coprocessor unusable exception

## Opcode Bit Encoding:

<b>LWCz</b>	Bit #	31	30	29	28	27	26	0
LWC1		1	1	0	0	0	1	
	Bit #	31	30	29	28	27	26	0
LWC2		1	1	0	0	1	0	
	Bit #	31	30	29	28	27	26	0
LWC3		1	1	0	0	1	1	
		<div style="border-top: 1px solid black; width: 100%; margin-bottom: 5px;"></div> Opcode				<div style="border-top: 1px solid black; width: 100%; margin-bottom: 5px;"></div> Coprocessor Unit Number		

# LWL                      Load Word Left                      LWL

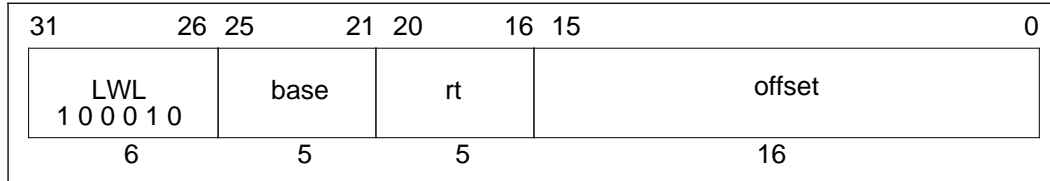

## Format:

LWL rt, offset(base)

## Description:

This instruction can be used in combination with the LWR instruction to load a register with four consecutive bytes from memory, when the bytes cross a word boundary. LWL loads the left portion of the register with the appropriate part of the high-order word; LWR loads the right portion of the register with the appropriate part of the low-order word.

The LWL instruction adds its sign-extended 16-bit *offset* to the contents of general register *base* to form a virtual address which can specify an arbitrary byte. It reads bytes only from the word in memory which contains the specified starting byte. From one to four bytes will be loaded, depending on the starting byte specified.

Conceptually, it starts at the specified byte in memory and loads that byte into the high-order (left-most) byte of the register; then it loads bytes from memory into the register until it reaches the low-order byte of the word in memory. The least-significant (right-most) byte(s) of the register will not be changed.

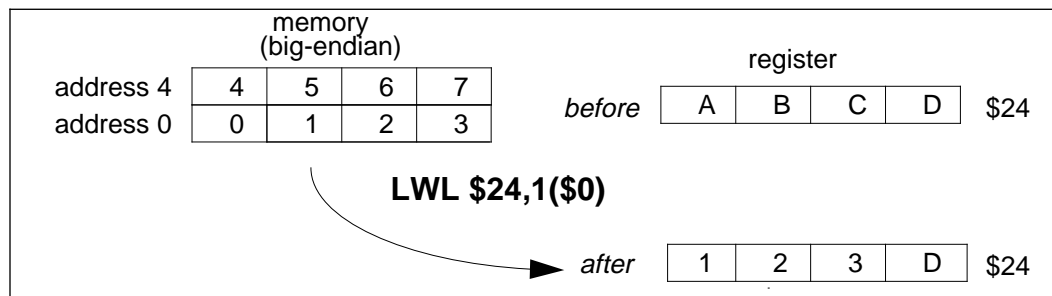

**LWL****Load Word Left  
(continued)****LWL**

The contents of general register *rt* are internally bypassed within the processor so that no NOP is needed between an immediately preceding load instruction which specifies register *rt* and a following LWL (or LWR) instruction which also specifies register *rt*.

No address exceptions due to alignment are possible.

**Operation:**

```

T:  vAddr ← ((offset15)16 || offset15...0) + GPR[base]
     (pAddr, uncached) ← AddressTranslation (vAddr, DATA)
     pAddr ← pAddrPSIZE-1...2 || (pAddr1...0 xor ReverseEndian2)
     if BigEndianMem = 0 then
         pAddr ← pAddrPSIZE-31...2 || 02
     endif
     byte ← vAddr1...0 xor BigEndianCPU2
     mem ← LoadMemory (uncached, byte, pAddr, vAddr, DATA)
     GPR[rt] ← mem7+8*byte...0 || GPR[rt]23-8*byte...0

```

**LWL****Load Word Left  
(continued)****LWL**

Given a doubleword in a register and a doubleword in memory, the operation of LWL is as follows:

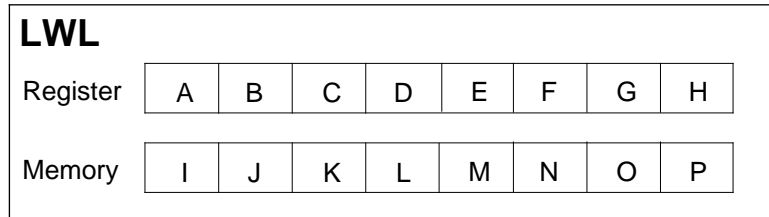

vAddr <sub>2..0</sub>	BigEndianCPU = 0				BigEndianCPU = 1			
	destination	type	offset		destination	type	offset	
			LEM	BEM			LEM	BEM
0	S S S S P F G H	0	0	7	S S S S I J K L	3	4	0
1	S S S S O P G H	1	0	6	S S S S J K L H	2	4	1
2	S S S S N O P H	2	0	5	S S S S K L G H	1	4	2
3	S S S S M N O P	3	0	4	S S S S L F G H	0	4	3
4	S S S S L F G H	0	4	3	S S S S M N O P	3	0	4
5	S S S S K L G H	1	4	2	S S S S N O P H	2	0	5
6	S S S S J K L H	2	4	1	S S S S O P G H	1	0	6
7	S S S S I J K L	3	4	0	S S S S P F G H	0	0	7

*LEM* Little-endian memory (BigEndianMem = 0)  
*BEM* BigEndianMem = 1  
*Type* AccessType sent to memory  
*Offset* pAddr<sub>2...0</sub> sent to memory  
*S* sign-extend of destination<sub>31</sub>

**Exceptions:**

TLB refill exception  
 TLB invalid exception  
 Bus error exception  
 Address error exception

# LWR                      Load Word Right                      LWR

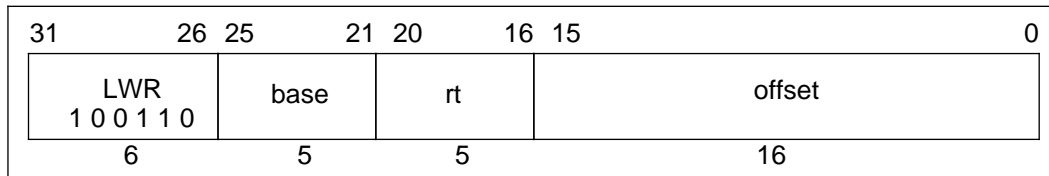

## Format:

LWR *rt*, offset(*base*)

## Description:

This instruction can be used in combination with the LWL instruction to load a register with four consecutive bytes from memory, when the bytes cross a word boundary. LWR loads the right portion of the destination register *rt* with the appropriate part of the low-order word; LWL loads the left portion of the register with the appropriate part of the high-order word.

The LWR instruction adds its sign-extended 16-bit *offset* to the contents of general register *base* to form a virtual address which can specify an arbitrary byte. It loads bytes only from the word in memory which contains the specified starting byte. From one to four bytes will be merged into the destination register *rt*, depending on the starting byte specified.

Conceptually, it starts at the specified byte in memory and loads that byte into the low-order (right-most) byte of the register; then it loads bytes from memory into the register until it reaches the high-order byte of the word in memory. The most significant (left-most) byte(s) of the register will not be changed

The contents of general register *rt* are internally bypassed within the processor so that no NOP is needed between an immediately preceding load instruction which specifies register *rt* and a following LWR (or LWL) instruction which also specifies register *rt*.

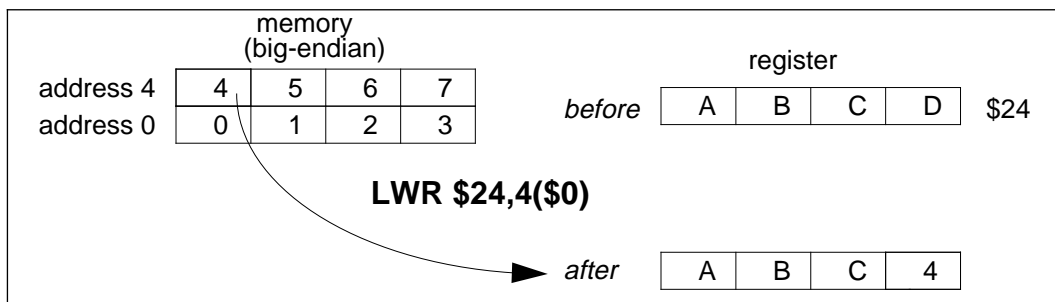

No address exceptions due to alignment are possible.

# LWR

## Load Word Right (continued)

# LWR

### Operation:

```

T: vAddr ← ((offset15)16 || offset15..0) + GPR[base]
(pAddr, uncached) ← AddressTranslation (vAddr, DATA)
pAddr ← pAddrPSIZE-1..2 || (pAddr1..0 xor ReverseEndian2)
if BigEndianMem = 0 then
    pAddr ← pAddrPSIZE-31..2 || 02
endif
byte ← vAddr1..0 xor BigEndianCPU2
mem ← LoadMemory (uncached, byte, pAddr, vAddr, DATA)
GPR[rt] ← mem31..32-8*byte || GPR[rt]31-8*byte..0

```

Given a word in a register and a word in memory, the operation of LWR is as follows:

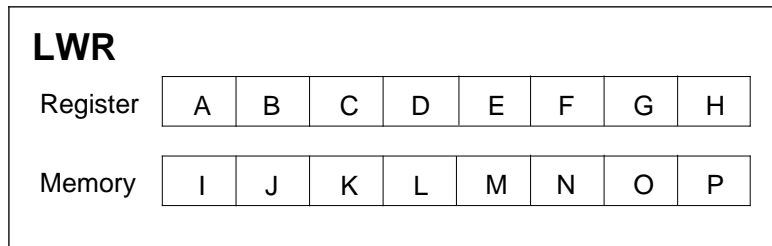

vAddr <sub>2..0</sub>	BigEndianCPU = 0				BigEndianCPU = 1			
	destination	type	offset		destination	type	offset	
			LEM	BEM			LEM	BEM
0	S S S S M N O P	0	0	4	X X X X E F G I	0	7	0
1	X X X X E M N O	1	1	4	X X X X E F I J	1	6	0
2	X X X X E F M N	2	2	4	X X X X E I J K	2	5	0
3	X X X X E F G M	3	3	4	S S S S I J K L	3	4	0
4	S S S S I J K L	0	4	0	X X X X E F G M	0	3	4
5	X X X X E I J K	1	5	0	X X X X E F M N	1	2	4
6	X X X X E F I J	2	6	0	X X X X E M N O	2	1	4
7	X X X X E F G I	3	7	0	S S S S M N O P	3	0	4

*LEM* Little-endian memory (BigEndianMem = 0)  
*BEM* BigEndianMem = 1  
*Type* AccessType sent to memory  
*Offset* pAddr<sub>2..0</sub> sent to memory  
*S* sign-extend of destination<sub>31</sub>  
*X* unchanged or sign-extend of destination<sub>31</sub>

### Exceptions:

TLB refill exception  
 TLB invalid exception  
 Bus error exception  
 Address error exception



# MFCz      Move From Coprocessor      MFCz

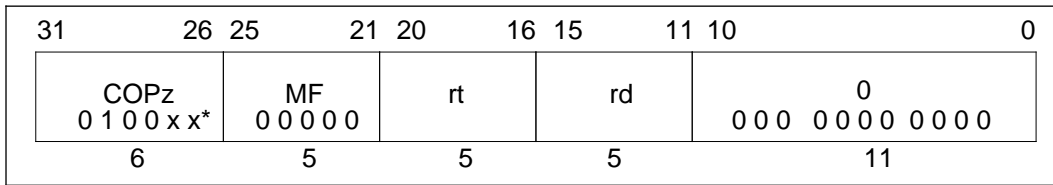

**Format:**

MFCz rt, rd

**Description:**

The contents of coprocessor register *rd* of coprocessor *z* are loaded into general register *rt*.

**Operation:**

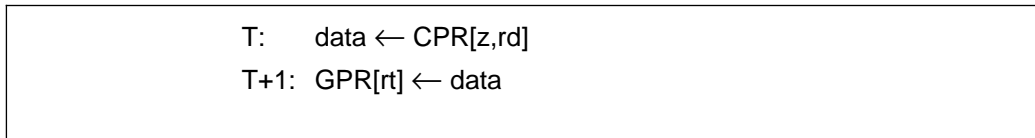

**Exceptions:**

- Coprocessor unusable exception
- Reserved instruction exception (coprocessor 3)

**Opcode Bit Encoding:**

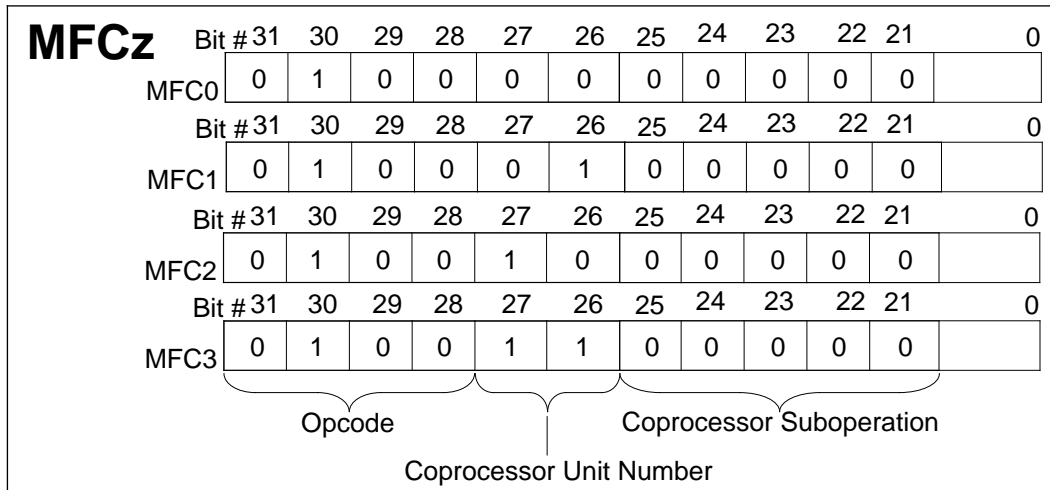

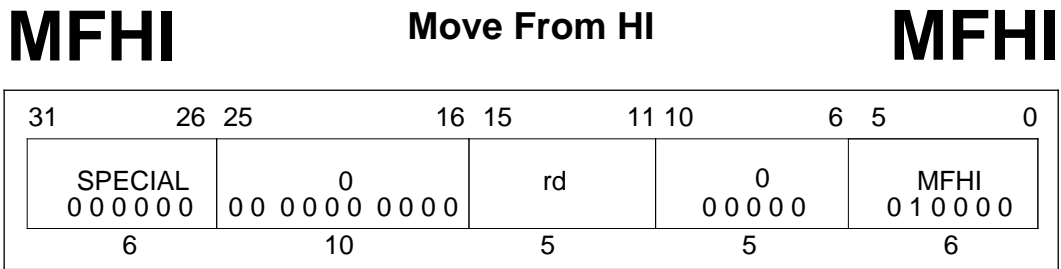
**Format:**

MFHI rd

**Description:**

The contents of special register *HI* are loaded into general register *rd*.

To ensure proper operation in the event of interruptions, the two instructions which follow a MFHI instruction may not be any of the instructions which modify the *HI* register: MULT, MULTU, DIV, DIVU, MTHI.

**Operation:**

T:      GPR[rd] ← HI
----------------------

**Exceptions:**

None

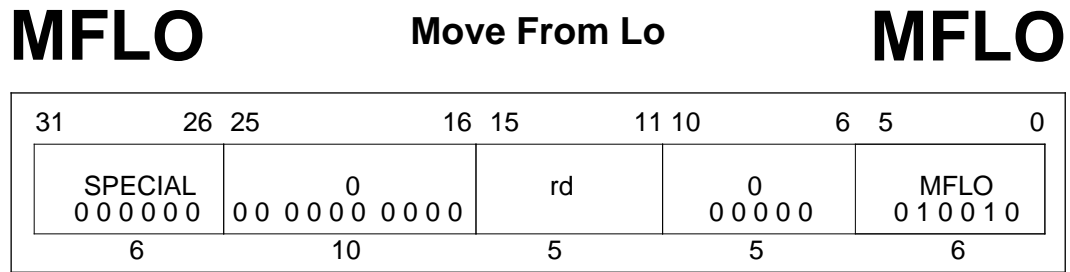

MFLO rd

**Description:**

The contents of special register *LO* are loaded into general register *rd*.

To ensure proper operation in the event of interruptions, the two instructions which follow a MFLO instruction may not be any of the instructions which modify the *LO* register: MULT, MULTU, DIV, DIVU, MTLO.

**Operation:**

T: GPR[rd] ← LO

**Exceptions:**

None

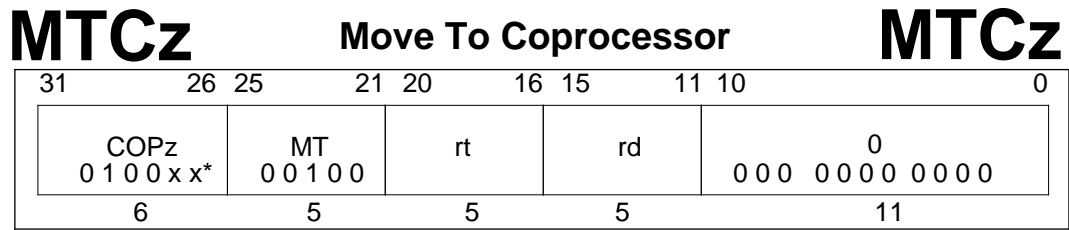
**Format:**

MTCz rt, rd

**Description:**The contents of general register *rt* are loaded into coprocessor register *rd* of coprocessor *z*.**Operation:**

32	T: data ← GPR[rt] T+1: CPR[z,rd] ← data
----	--

**Exceptions:**

Coprocessor unusable exception

**\*Opcode Bit Encoding:**

<b>MTCz</b>	Bit #	31	30	29	28	27	26	25	24	23	22	21	0
	COP0	0	1	0	0	0	0	0	0	1	0	0	
	Bit #	31	30	29	28	27	26	25	24	23	22	21	0
	COP1	0	1	0	0	0	1	0	0	1	0	0	
	Bit #	31	30	29	28	27	26	25	24	23	22	21	0
COP2	0	1	0	0	1	0	0	0	1	0	0		
Bit #	31	30	29	28	27	26	25	24	23	22	21	0	
COP3	0	1	0	0	1	1	0	0	1	0	0		
		Opcode			Coprocessor Unit Number			Coprocessor Suboperation					

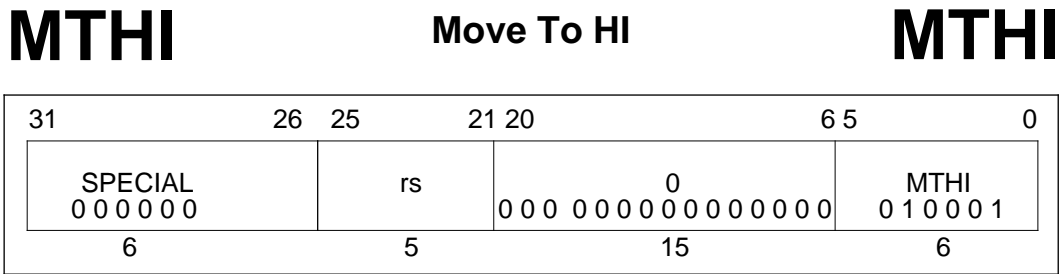
**Format:**

MTHI rs

**Description:**

The contents of general register *rs* are loaded into special register *HI*.

Instructions that write to the *HI* and *LO* registers are not interlocked and serialized; a result written to the *HI/LO* pair must be read before another result is written. If a MTHI operation is executed following a MULT, MULTU, DIV, or DIVU instruction, but before any MFLO, MFHI, MTLO, or MTHI instructions, the contents of the companion special register *LO* are undefined.

**Operation:**

<p>T-2: HI ← undefined</p> <p>T-1: HI ← undefined</p> <p>T: HI ← GPR[rs]</p>
--

**Exceptions:**

None

# MTLO                      Move To LO                      MTLO

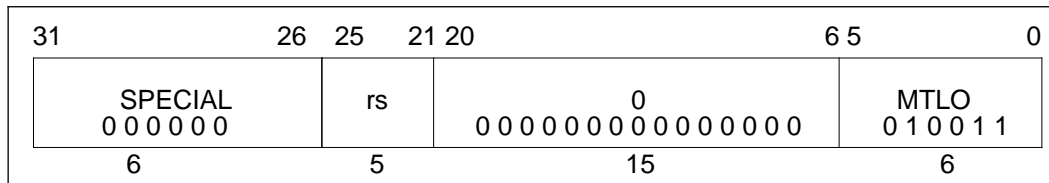
**Format:**

MTLO rs

**Description:**

The contents of general register *rs* are loaded into special register *LO*.

Instructions that write to the *HI* and *LO* registers are not interlocked and serialized; a result written to the *HI/LO* pair must be read before another result is written. If a MTLO operation is executed following a MULT, MULTU, DIV, or DIVU instruction, but before any MFLO, MFHI, MTLO, or MTHI instructions, the contents of the companion special register *HI* are undefined.

**Operation:**

<p style="margin: 0;">T-2: LO ← undefined</p> <p style="margin: 0;">T-1: LO ← undefined</p> <p style="margin: 0;">T:    LO ← GPR[rs]</p>
--

**Exceptions:**

None

# MULT Multiply Word MULT

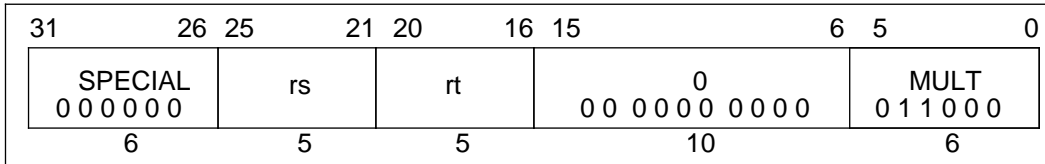
**Format:**

MULT rs, rt

**Description:**

The contents of general registers *rs* and *rt* are multiplied, treating both operands as 32-bit 2's complement values. No integer overflow exception occurs under any circumstances.

When the operation completes, the low-order word of the double result is loaded into special register *LO*, and the high-order word of the double result is loaded into special register *HI*.

If either of the two preceding instructions is MFHI or MFLO, the results of these instructions are undefined. Correct operation requires separating reads of *HI* or *LO* from writes by a minimum of two other instructions.

**Operation:**

T-2:	LO	← undefined
	HI	← undefined
T-1:	LO	← undefined
	HI	← undefined
T:	t	← GPR[rs] * GPR[rt]
	LO	← t <sub>31...0</sub>
	HI	← t <sub>63...32</sub>

**Exceptions:**

None

# MULTU Multiply Unsigned Word MULTU

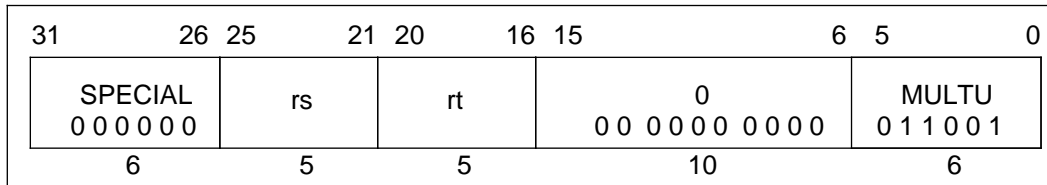

## Format:

MULTU rs, rt

## Description:

The contents of general register *rs* and the contents of general register *rt* are multiplied, treating both operands as unsigned values. No overflow exception occurs under any circumstances.

When the operation completes, the low-order word of the double result is loaded into special register *LO*, and the high-order word of the double result is loaded into special register *HI*.

If either of the two preceding instructions is MFHI or MFLO, the results of these instructions are undefined. Correct operation requires separating reads of *HI* or *LO* from writes by a minimum of two instructions.

## Operation:

T-2:	LO	← undefined
	HI	← undefined
T-1:	LO	← undefined
	HI	← undefined
T:	t	← (0    GPR[rs]) * (0    GPR[rt])
	LO	← t <sub>31...0</sub>
	HI	← t <sub>63...32</sub>

## Exceptions:

None

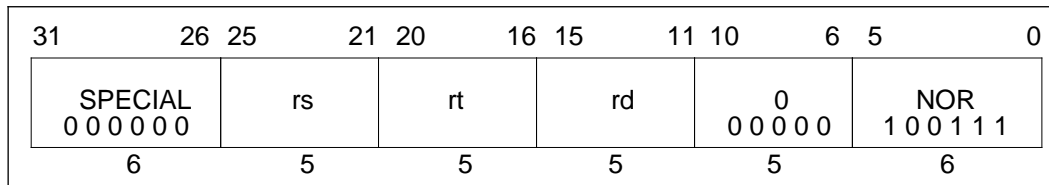

**NOR****Nor****NOR****Format:**

NOR rd, rs, rt

**Description:**

The contents of general register *rs* are combined with the contents of general register *rt* in a bit-wise logical NOR operation. The result is placed into general register *rd*.

**Operation:**

T:  $GPR[rd] \leftarrow GPR[rs] \text{ nor } GPR[rt]$

**Exceptions:**

None

# OR Or OR

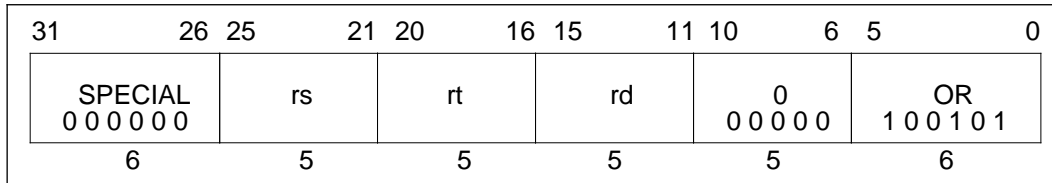
**Format:**

OR rd, rs, rt

**Description:**

The contents of general register *rs* are combined with the contents of general register *rt* in a bit-wise logical OR operation. The result is placed into general register *rd*.

**Operation:**

T:	$GPR[rd] \leftarrow GPR[rs] \text{ or } GPR[rt]$
----	--

**Exceptions:**

None

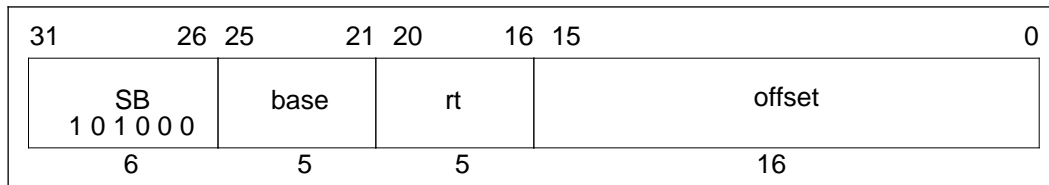

# SB Store Byte SB

**Format:**

SB rt, offset(base)

**Description:**

The 16-bit *offset* is sign-extended and added to the contents of general register *base* to form a virtual address. The least-significant byte of register *rt* is stored at the effective address.

**Operation:**

T:  $vAddr \leftarrow ((offset_{15})^{16} \parallel offset_{15..0}) + GPR[base]$   
 $(pAddr, uncached) \leftarrow AddressTranslation(vAddr, DATA)$   
 $pAddr \leftarrow pAddr_{P\_SIZE-1..2} \parallel (pAddr_{1..0} \text{ xor } ReverseEndian^2)$   
 $byte \leftarrow vAddr_{1..0} \text{ xor } BigEndianCPU^2$   
 $data \leftarrow GPR[rt]_{31-8*byte..0} \parallel 0^{8*byte}$   
 StoreMemory(uncached, BYTE, data, pAddr, vAddr, DATA)

**Exceptions:**

- TLB refill exception
- TLB invalid exception
- TLB modification exception
- Bus error exception
- Address error exception

# SH Store Halfword SH

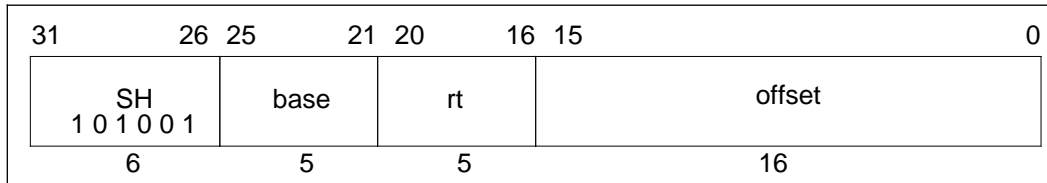
**Format:**SH *rt*, *offset*(*base*)**Description:**

The 16-bit *offset* is sign-extended and added to the contents of general register *base* to form an unsigned effective address. The least-significant halfword of register *rt* is stored at the effective address. If the least-significant bit of the effective address is non-zero, an address error exception occurs.

**Operation:**

T:  $vAddr \leftarrow ((offset_{15})^{16} \parallel offset_{15..0}) + GPR[base]$   
 $(pAddr, uncached) \leftarrow AddressTranslation(vAddr, DATA)$   
 $pAddr \leftarrow pAddr_{PSIZE-1..2} \parallel (pAddr_{1..0} \text{ xor } (ReverseEndian \parallel 0))$   
 $byte \leftarrow vAddr_{1..0} \text{ xor } (BigEndianCPU \parallel 0)$   
 $data \leftarrow GPR[rt]_{31-8*byte..0} \parallel 0^{8*byte}$   
 StoreMemory (uncached, HALFWORD, data, pAddr, vAddr, DATA)

**Exceptions:**

- TLB refill exception
- TLB invalid exception
- TLB modification exception
- Bus error exception
- Address error exception

# SLL                      Shift Word Left Logical                      SLL

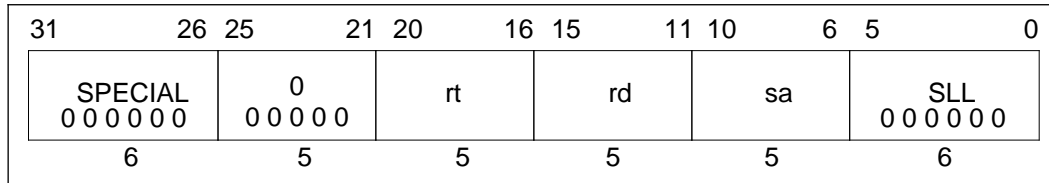
**Format:**

SLL rd, rt, sa

**Description:**

The contents of the low-order word of general register *rt* are shifted left by *sa* bits, inserting zeros into the low-order bits. The word result is placed in register *rd*.

If *rd* is a 64-bit register, the result word is sign-extended when it is placed in the register. The result word is sign extended even if the shift amount is zero; this instructions with a zero shift amount can be used to truncate a 64-bit value and sign extend the lower word. Unlike nearly all other word operations the input operand does not have to be a properly sign-extended word value to produce a valid result.

**Operation:**

$$T: \text{ GPR}[rd] \leftarrow \text{GPR}[rt]_{31-sa\dots 0} \parallel 0^{sa}$$

**Exceptions:**

None

# SLLV Shift Word Left Logical Variable SLLV

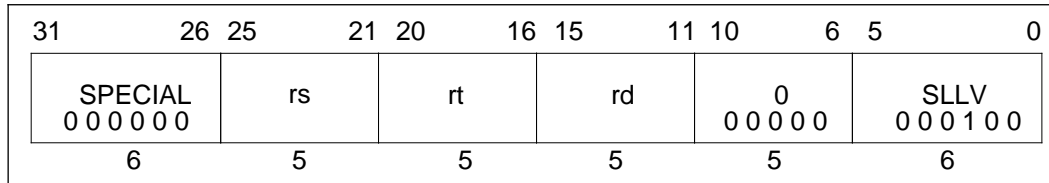
**Format:**

SLLV rd, rt, rs

**Description:**

The contents of the low-order word of general register *rt* are shifted left the number of bits specified by the low-order five bits contained in general register *rs*, inserting zeros into the low-order bits. The word-value result is placed in register *rd*.

**Operation:**

T:  $s \leftarrow \text{GP}[\text{rs}]_{4..0}$   
 $\text{GPR}[\text{rd}] \leftarrow \text{GPR}[\text{rt}]_{(31-s)..0} \parallel 0^s$

**Exceptions:**

None

# SLT                      Set On Less Than                      SLT

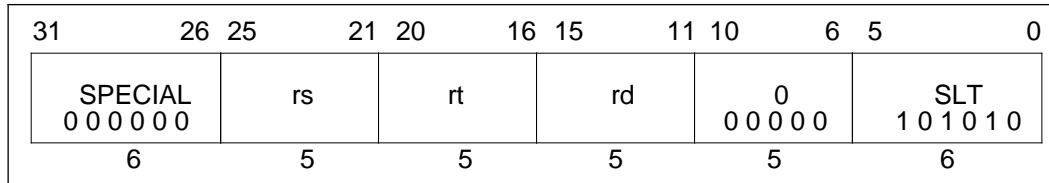
**Format:**

SLT rd, rs, rt

**Description:**

The contents of general register *rt* are subtracted from the contents of general register *rs*. Considering both quantities as signed integers, if the contents of general register *rs* are less than the contents of general register *rt*, the result is set to one; otherwise the result is set to zero.

The result is placed into general register *rd*.

No integer overflow exception occurs under any circumstances. The comparison is valid even if the subtraction used during the comparison overflows.

**Operation:**

```

T:  if GPR[rs] < GPR[rt] then
      GPR[rd] ← 031 || 1
    else
      GPR[rd] ← 032
    endif

```

**Exceptions:**

None

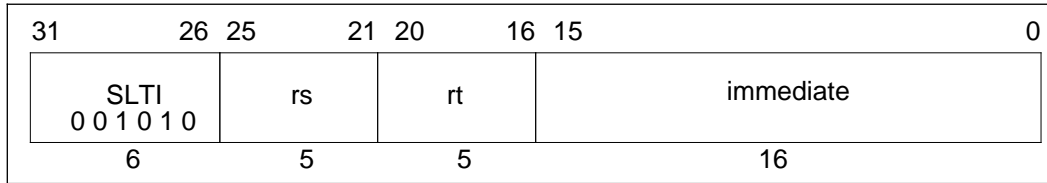

# SLTI      Set On Less Than Immediate      SLTI

**Format:**

SLTI *rt*, *rs*, *immediate*

**Description:**

The 16-bit *immediate* is sign-extended and subtracted from the contents of general register *rs*. Considering both quantities as signed integers, if *rs* is less than the sign-extended *immediate*, the result is set to one; otherwise the result is set to zero.

The result is placed into general register *rt*.

No integer overflow exception occurs under any circumstances. The comparison is valid even if the subtraction used during the comparison overflows.

**Operation:**

```

T:  if GPR[rs] < (immediate15)16 || immediate15...0 then
      GPR[rd] ← 031 || 1
    else
      GPR[rd] ← 032
    endif

```

**Exceptions:**

None

# SLTIU      Set On Less Than Immediate Unsigned      SLTIU

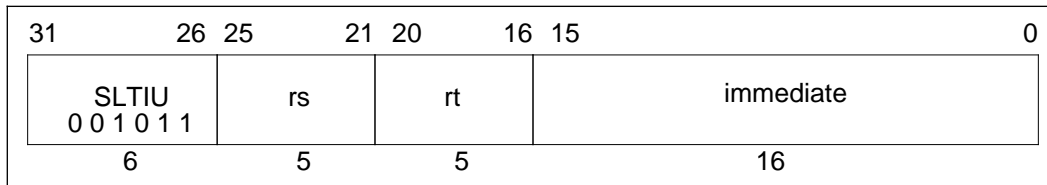
**Format:**

SLTIU rt, rs, immediate

**Description:**

The 16-bit *immediate* is sign-extended and subtracted from the contents of general register *rs*. Considering both quantities as unsigned integers, if *rs* is less than the sign-extended immediate, the result is set to one; otherwise the result is set to zero.

The result is placed into general register *rt*.

No integer overflow exception occurs under any circumstances. The comparison is valid even if the subtraction used during the comparison overflows.

**Operation:**

```

T:  if (0 || GPR[rs]) < (immediate15)16 || immediate15...0 then
      GPR[rd] ← 031 || 1
    else
      GPR[rd] ← 032
    endif
  endif

```

**Exceptions:**

None

# SLTU      Set On Less Than Unsigned      SLTU

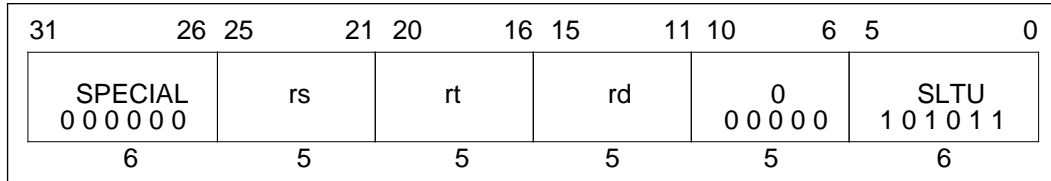
**Format:**

SLTU rd, rs, rt

**Description:**

The contents of general register *rt* are subtracted from the contents of general register *rs*. Considering both quantities as unsigned integers, if the contents of general register *rs* are less than the contents of general register *rt*, the result is set to one; otherwise the result is set to zero.

The result is placed into general register *rd*.

No integer overflow exception occurs under any circumstances. The comparison is valid even if the subtraction used during the comparison overflows.

**Operation:**

```

T:  if (0 || GPR[rs] < 0 || GPR[rt] then
      GPR[rd] ← 031 || 1
    else
      GPR[rd] ← 032
    endif

```

**Exceptions:**

None

# SRA      Shift Word Right Arithmetic      SRA

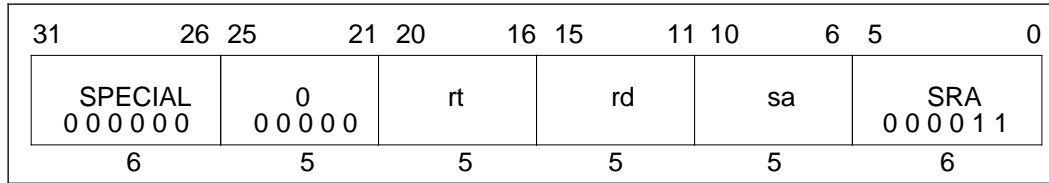
**Format:**

SRA rd, rt, sa

**Description:**

The contents of the low-order word of general register *rt* are shifted right by *sa* bits, sign-extending the high-order bits.

The result is placed in register *rd*.

**Operation:**

$$T: \quad \text{GPR}[rd] \leftarrow (\text{GPR}[rt]_{31})^{sa} \parallel \text{GPR}[rt]_{31 \dots sa}$$
**Exceptions:**

None

# SRAV                      Shift Word Right Arithmetic Variable                      SRAV

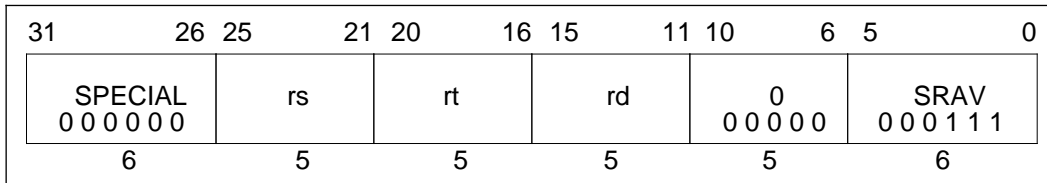
**Format:**

SRAV rd, rt, rs

**Description:**

The contents of general register *rt* are shifted right by the number of bits specified by the low-order five bits of general register *rs*, sign-extending the high-order bits.

The result is placed in register *rd*.

**Operation:**

T:  $s \leftarrow \text{GPR}[rs]_{4..0}$   
 $\text{GPR}[rd] \leftarrow (\text{GPR}[rt]_{31})^s \parallel \text{GPR}[rt]_{31..s}$

**Exceptions:**

None

# SRL                      Shift Word Right Logical                      SRL

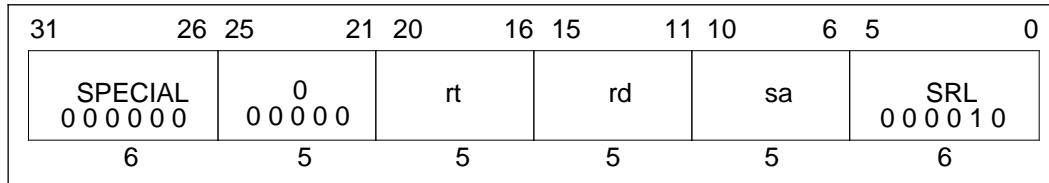
**Format:**

SRL rd, rt, sa

**Description:**

The low-order word of general register *rt* is shifted right by *sa* bits, inserting zeros into the high-order bits.

The result is placed in register *rd*.

Operation:

T:     $\text{GPR}[rd] \leftarrow 0^{sa} \parallel \text{GPR}[rt]_{31\dots sa}$

**Exceptions:**

None

# SRLV Shift Word Right Logical Variable SRLV

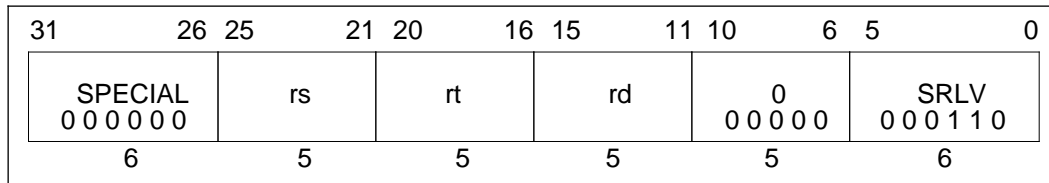
**Format:**

SRLV rd, rt, rs

**Description:**

The low-order word of general register *rt* are shifted right by the number of bits specified by the low-order five bits of general register *rs*, inserting zeros into the high-order bits.

The result is placed in register *rd*.

**Operation:**

T:  $s \leftarrow \text{GPR}[rs]_{4...0}$   
 $\text{GPR}[rd] \leftarrow 0^s \parallel \text{GPR}[rt]_{31...s}$

**Exceptions:**

None

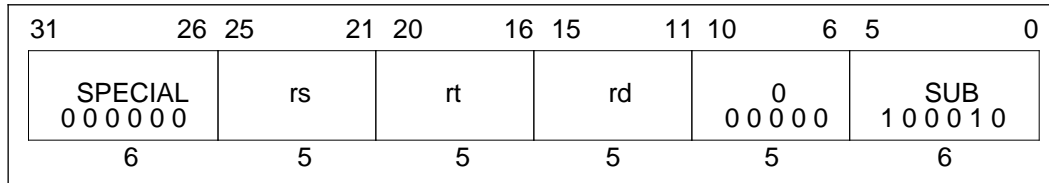
**SUB****Subtract Word****SUB****Format:**

SUB rd, rs, rt

**Description:**

The contents of general register *rt* are subtracted from the contents of general register *rs* to form a result. The result is placed into general register *rd*.

The only difference between this instruction and the SUBU instruction is that SUBU never traps on overflow.

An integer overflow exception takes place if the carries out of bits 30 and 31 differ (2's complement overflow). The destination register *rd* is not modified when an integer overflow exception occurs.

**Operation:**

$$T: \text{GPR}[rd] \leftarrow \text{GPR}[rs] - \text{GPR}[rt]$$
**Exceptions:**

Integer overflow exception

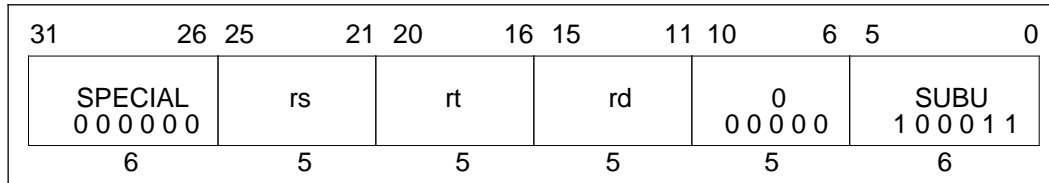

# SUBU Subtract Unsigned Word SUBU

**Format:**

SUBU rd, rs, rt

**Description:**

The contents of general register *rt* are subtracted from the contents of general register *rs* to form a result.

The result is placed into general register *rd*.

The only difference between this instruction and the SUB instruction is that SUBU never traps on overflow. No integer overflow exception occurs under any circumstances.

**Operation:**

T:   GPR[rd] ← GPR[rs] – GPR[rt]
----------------------------------

**Exceptions:**

None



# SWCz    Store Word From Coprocessor    SWCz

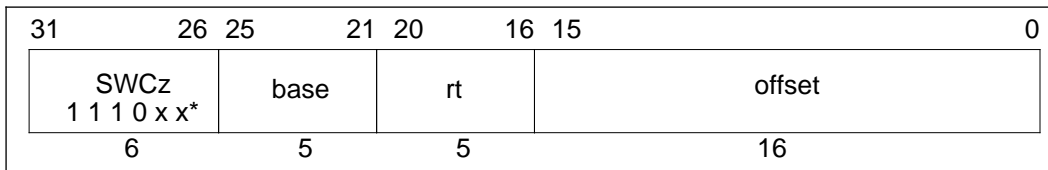

**Format:**

SWCz rt, offset(base)

**Description:**

The 16-bit *offset* is sign-extended and added to the contents of general register *base* to form a virtual address. Coprocessor unit *z* sources a word, which the processor writes to the addressed memory location.

The data to be stored is defined by individual coprocessor specifications.

This instruction is not valid for use with CP0.

If either of the two least-significant bits of the effective address is non-zero, an address error exception occurs.

Execution of the instruction referencing coprocessor 3 causes a reserved instruction exception, not a coprocessor unusable exception.

**Operation:**

```

T:   vAddr ← ((offset15)16 || offset15..0) + GPR[base]
      (pAddr, uncached) ← AddressTranslation (vAddr, DATA)
      byte ← vAddr1..0
      data ← COPzSW (byte, rt)
      StoreMemory (uncached, WORD, data, pAddr, vAddr, DATA)
    
```

**Exceptions:**

- TLB refill exception
- TLB invalid exception
- TLB modification exception
- Bus error exception
- Address error exception
- Coprocessor unusable exception

**Opcode Bit Encoding:**

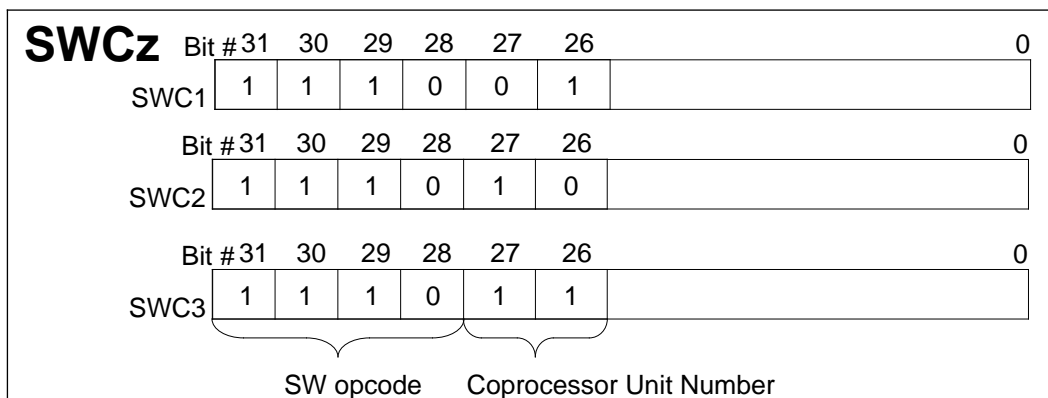

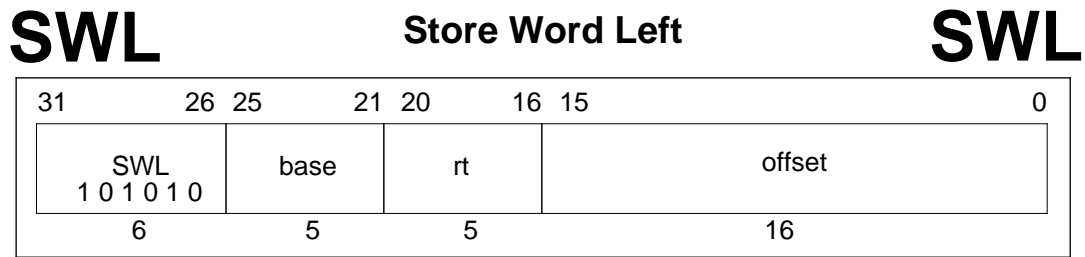
**Format:**

SWL rt, offset(base)

**Description:**

This instruction can be used with the SWR instruction to store the contents of a register into four consecutive bytes of memory, when the bytes cross a word boundary. SWL stores the left portion of the register into the appropriate part of the high-order word of memory; SWR stores the right portion of the register into the appropriate part of the low-order word.

The SWL instruction adds its sign-extended 16-bit *offset* to the contents of general register *base* to form a virtual address which may specify an arbitrary byte. It alters only the word in memory which contains that byte. From one to four bytes will be stored, depending on the starting byte specified.

Conceptually, it starts at the most-significant byte of the register and copies it to the specified byte in memory; then it copies bytes from register to memory until it reaches the low-order byte of the word in memory.

No address exceptions due to alignment are possible.

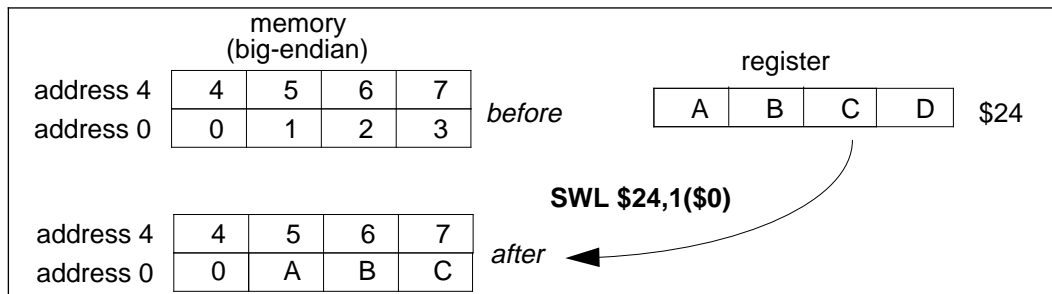
**Operation:**

```

T:   vAddr ← ((offset15)16 || offset15...0) + GPR[base]
      (pAddr, uncached) ← AddressTranslation(vAddr, DATA)
      pAddr ← pAddrPSIZE-1...2 || (pAddr1...0 xor ReverseEndian2)
      If BigEndianMem = 0 then
        pAddr ← pAddrPSIZE-1...2 || 02
      endif
      byte ← vAddr1...0 xor BigEndianCPU2
      data ← 024-8*byte || GPR[rt]31...24-8*byte
      Storememory(uncached, byte, data, pAddr, vAddr, DATA)

```

# SWL

## Store Word Left (Continued)

# SWL

Given a doubleword in a register and a doubleword in memory, the operation of SWL is as follows:

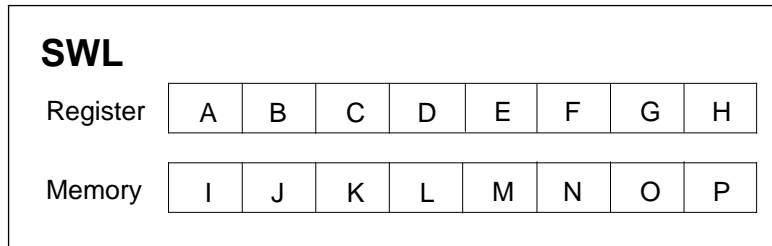

vAddr <sub>2..0</sub>	BigEndianCPU = 0				BigEndianCPU = 1			
	destination	type	offset		destination	type	offset	
			LEM	BEM			LEM	BEM
0	I J K L M N O E	0	0	7	E F G H M N O P	3	4	0
1	I J K L M N E F	1	0	6	I E F G M N O P	2	4	1
2	I J K L M E F G	2	0	5	I J E F M N O P	1	4	2
3	I J K L E F G H	3	0	4	I J K E M N O P	0	4	3
4	I J K E M N O P	0	4	3	I J K L E F G H	3	0	4
5	I J E F M N O P	1	4	2	I J K L M E F G	2	0	5
6	I E F G M N O P	2	4	1	I J K L M N E F	1	0	6
7	E F G H M N O P	3	4	0	I J K L M N O E	0	0	7

*LEM* Little-endian memory (BigEndianMem = 0)  
*BEM* BigEndianMem = 1  
*Type* AccessType sent to memory  
*Offset* pAddr<sub>2...0</sub> sent to memory

**Exceptions:**

- TLB refill exception
- TLB invalid exception
- TLB modification exception
- Bus error exception
- Address error exception

# SWR                      Store Word Right                      SWR

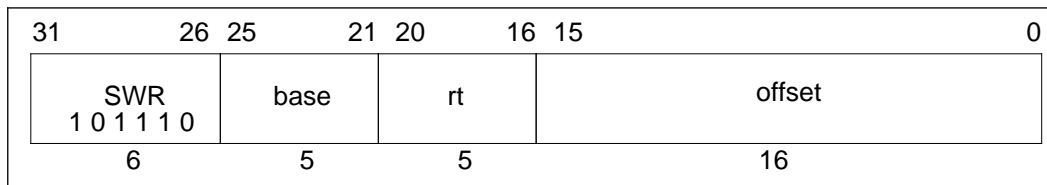

## Format:

SWR rt, offset(base)

## Description:

This instruction can be used with the SWL instruction to store the contents of a register into four consecutive bytes of memory, when the bytes cross a boundary between two words. SWR stores the right portion of the register into the appropriate part of the low-order word; SWL stores the left portion of the register into the appropriate part of the low-order word of memory.

The SWR instruction adds its sign-extended 16-bit *offset* to the contents of general register *base* to form a virtual address which may specify an arbitrary byte. It alters only the word in memory which contains that byte. From one to four bytes will be stored, depending on the starting byte specified.

Conceptually, it starts at the least-significant (rightmost) byte of the register and copies it to the specified byte in memory; then copies bytes from register to memory until it reaches the high-order byte of the word in memory.

No address exceptions due to alignment are possible.

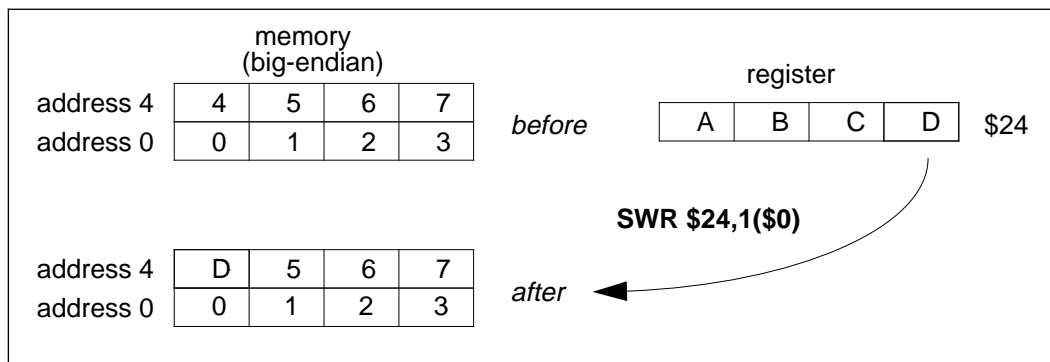

## Operation:

```

T:   vAddr ← ((offset15)16 || offset15...0) + GPR[base]
      (pAddr, uncached) ← AddressTranslation(vAddr, DATA)
      pAddr ← pAddrPSIZE-1...2 || (pAddr1...0 xor ReverseEndian2)
      BigEndianMem = 0 then
        pAddr ← pAddrPSIZE-31...2 || 02
      endif
      byte ← vAddr1...0 xor BigEndianCPU2
      data ← GPR[rt]31-8*byte || 08*byte
      Storememory(uncached, WORD-byte, data, pAddr, vAddr, DATA)
  
```

# SWR

## Store Word Right (Continued)

# SWR

Given a doubleword in a register and a doubleword in memory, the operation of SWR is as follows:

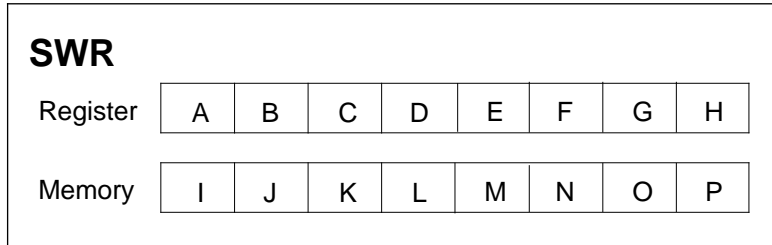

vAddr <sub>2..0</sub>	BigEndianCPU = 0				BigEndianCPU = 1			
	destination	type	offset		destination	type	offset	
			LEM	BEM			LEM	BEM
0	I J K L E F G H	3	0	4	H J K L M N O P	0	7	0
1	I J K L F G H P	2	1	4	G H K L M N O P	1	6	0
2	I J K L G H O P	1	2	4	F G H L M N O P	2	5	0
3	I J K L H N O P	0	3	4	E F G H M N O P	3	4	0
4	E F G H M N O P	3	4	0	I J K L H N O P	0	3	4
5	F G H L M N O P	2	5	0	I J K L G H O P	1	2	4
6	G H K L M N O P	1	6	0	I J K L F G H P	2	1	4
7	H J K L M N O P	0	7	0	I J K L E F G H	3	0	4

*LEM* Little-endian memory (BigEndianMem = 0)  
*BEM* BigEndianMem = 1  
*Type* AccessType sent to memory  
*Offset* pAddr<sub>2...0</sub> sent to memory

**Exceptions:**

- TLB refill exception
- TLB invalid exception
- TLB modification exception
- Bus error exception
- Address error exception

# SYSCALL      System Call      SYSCALL

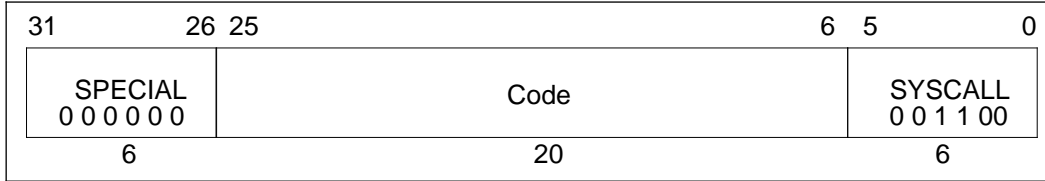
**Format:**

SYSCALL

**Description:**

A system call exception occurs, immediately and unconditionally transferring control to the exception handler.

The code field is available for use as software parameters, but is retrieved by the exception handler only by loading the contents of the memory word containing the instruction.

**Operation:**

T:    SystemCallException
---------------------------

**Exceptions:**

System Call exception

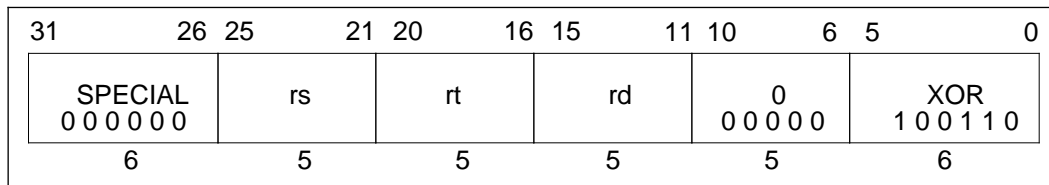

**XOR****Exclusive Or****XOR****Format:**

XOR rd, rs, rt

**Description:**

The contents of general register *rs* are combined with the contents of general register *rt* in a bit-wise logical exclusive OR operation.

The result is placed into general register *rd*.

**Operation:**

$$T: \quad \text{GPR}[rd] \leftarrow \text{GPR}[rs] \text{ xor } \text{GPR}[rt]$$
**Exceptions:**

None

# XORI Exclusive OR Immediate XORI

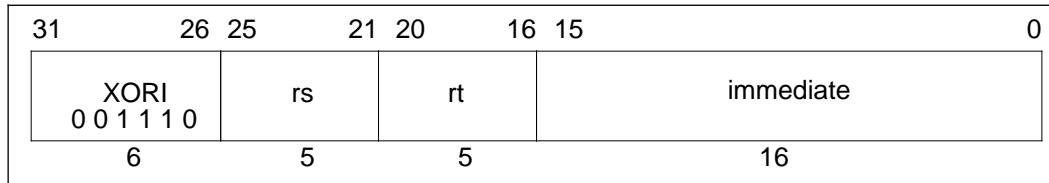
**Format:**

XORI *rt*, *rs*, *immediate*

**Description:**

The 16-bit *immediate* is zero-extended and combined with the contents of general register *rs* in a bit-wise logical exclusive OR operation.

The result is placed into general register *rt*.

**Operation:**

$$T: \text{GPR}[rt] \leftarrow \text{GPR}[rs] \text{ xor } (0^{16} \parallel \text{immediate})$$
**Exceptions:**

None

## Instruction Summary

<i>Instr Fields</i>						<i>Asm</i>	<i>Description</i>
<i>op</i>					<i>func</i>		
<i>31-26</i>	<i>25-21</i>	<i>20-16</i>	<i>15-11</i>	<i>10-6</i>	<i>5-0</i>		
<b>“Register” format instructions</b>							
0	rs1	rs2	rd	sa	0	sll	Shift left (to smaller bits) by a constant. <i>sll</i> is “logical”, brings in zeroes from the top. <i>srl</i> is “arithmetic”, duplicating bit 31, so implementing a correct signed division by $2^n$
0	rs1	rs2	rd	sa	2	srl	
0	rs1	rs2	rd	sa	3	sra	Shift right (to higher bits) by a constant, bringing in zeroes to the low bits
0	rs1	rs2	rd	0	4	sllv	shift (left logical, left arithmetic, and right) by the amount stored in another register
0	rs1	rs2	rd	0	6	srlv	
0	rs1	rs2	rd	0	7	srav	
0	rs	0			8	jr	Jump to address in register (no offset)
0	rs	0	rd	0	9	jalr	Call function at address from register. Can store the return address in any register, even though anything but <i>ra</i> is not normally useful.
0	×				12	syscall	Cause “syscall” trap, conventionally used for system call from user-mode to operating system
0	×				13	break	Cause “Bp” trap, conventionally used for debugger breakpoint.
0	0		rd	0	16	mfhi	Access to multiply/divide unit registers “lo” and “hi”. <i>mflo/mfhi</i> move data from “lo”/“hi” into an integer register; <i>mtlo/mthi</i> go the other way.
0	rs	0			17	mthi	
0	0		rd	0	18	mflo	
0	rs	0			19	mtlo	
0	rs1	rs2	0		24	mult	Multiply two integer registers, put result into “hi”/“lo” when done. <i>mult</i> sign-extends the result, but <i>multu</i> does not.
0	rs1	rs2	0		25	multu	
0	rs1	rs2	0		26	div	(signed and unsigned versions of) divide two integer registers and put the result (quotient) and remainder in “lo” and “hi” respectively.
0	rs1	rs2	0		27	divu	

<b>Instr Fields</b>						<b>Asm</b>	<b>Description</b>
<b>op</b>					<b>func</b>		
<b>31-26</b>	<b>25-21</b>	<b>20-16</b>	<b>15-11</b>	<b>10-6</b>	<b>5-0</b>		
0	rs1	rs2	rd	0	32	add	3-operand add. The only difference between them is that <i>add</i> causes a trap if a result overflows into bit 31, but <i>addu</i> never traps.
0	rs1	rs2	rd	0	33	addu	
0	rs1	rs2	rd	0	34	sub	3-operand subtract. <i>sub</i> can trap on overflow, <i>subu</i> won't.
0	rs1	rs2	rd	0	35	subu	
0	rs1	rs2	rd	0	36	and	3-operand bitwise logical operations
0	rs1	rs2	rd	0	37	or	
0	rs1	rs2	rd	0	38	xor	
0	rs1	rs2	rd	0	39	nor	
0	rs1	rs2	rd	0	42	slt	Set destination to 1 if rs1 <rs2, set destination to zero otherwise. <i>slt</i> uses signed comparison, and <i>sltu</i> unsigned.
0	rs1	rs2	rd	0	43	sltu	
<b>“PC-relative” test and branch</b>							
1	rs	0	offset			bltz	branch if rs1 <0 (top bit set)
1	rs	1	offset			bgez	branch if rs1 >= 0
1	rs	16	offset			bltzal	if rs1 <0 or rs1 >= 0 respectively, branch to function. Set ra to the notional “return” address, even if the branch is not taken.
1	rs	17	offset			bgezal	
<b>Long “in-region” jump and call</b>							
2	word address					j	unconditional jump (26-bit word address). Note that the top 4 bits of the program address of the target location comes from the instruction's own location. You have to use a <i>jr</i> (jump register) instruction to reach outside of your 256Mbyte region.
3	word address					jal	function call (26-bit word address)
<b>Compare and branch instructions</b>							
4	rs1	rs2	offset			beq	branch if rs1 == rs2
5	rs1	rs2	offset			bne	branch if rs1 != rs2
6	rs1	0	offset			blez	branch if rs1 <= 0 or rs1 > 0 respectively. Encoded as if they had two source operands with rs2 selecting zero.
7	rs1	0	offset			bgtz	
<b>“Immediate” arithmetic and logical instructions</b>							

<i>Instr Fields</i>						<i>Asm</i>	<i>Description</i>
<i>op</i>					<i>func</i>		
<b>31-26</b>	<b>25-21</b>	<b>20-16</b>	<b>15-11</b>	<b>10-6</b>	<b>5-0</b>		
8	rs	rd	signed constant			addi	Arithmetic operations with one source register, a 16-bit signed constant, and a separate destination. As for 3-operand arithmetic, the unsigned forms <i>addiu</i> and <i>subiu</i> have identical results but never cause an overflow trap. Note that “load immediate signed” can be synthesised as an <i>addi</i> with register <i>zero</i> .
9	rs	rd	signed constant			addiu	
10	rs	rd	signed constant			subi	
11	rs	rd	signed constant			subiu	
12	rs	rd	unsigned constant			andi	Logical operation with 16-bit constant, zero-extended for these instructions. “load immediate unsigned” is synthesised with an <i>ori</i> with register <i>zero</i> .
13	rs	rd	unsigned constant			ori	
14	rs	rd	unsigned constant			xori	
15	×	rd	unsigned constant			lui	Load UPPER immediate ( <i>not</i> unsigned). The 16-bit constant is loaded into the high-order 16-bits of the register, and the low-order bits cleared to zero. A “load immediate” with a value which won’t fit into 16 bits is synthesised by a <i>lui</i> followed by an <i>ori</i> , which fills in the low 16 bits.
<b>CPU control instructions (“Co-processor zero”)</b>							
24	0	rd	cs	0		mfc0	These instructions are described in the chapter “System Software Considerations”
24	4	rs	cd	0		mtc0	
24	8	0	offset			bc0f	
24	8	1	offset			bc0t	
24	16	0			1	tlbr	
24	16	0			2	tlbwi	
24	16	0			6	tlbwr	
24	16	0			8	tlbp	
24	16	0			16	rfe	
<b>Floating point instructions (except load/store)</b>							
25	Functions of these are detailed in the chapter “FLOATING POINT CO-PROCESSOR” above. Their encodings are detailed in the appendix “FP Instruction encoding”, below.						
<b>Load and store instructions</b>							
32	rs	rd	offset			lb	Load byte and sign-extend
33	rs	rd	offset			lh	Load halfword and sign-extend

<i>Instr Fields</i>						<i>Asm</i>	<i>Description</i>
<i>op</i>					<i>func</i>		
<b>31-26</b>	<b>25-21</b>	<b>20-16</b>	<b>15-11</b>	<b>10-6</b>	<b>5-0</b>		
34	rs	rd	offset			lwl	“Load word left”, see section on “Unaligned loads and stores”
35	rs	rd	offset			lw	load word
36	rs	rd	offset			lbu	Load byte and zero-extend
37	rs	rd	offset			lhu	Load halfword and zero-extend
38	rs	rd	offset			lwr	“Load word right”, see section on “Unaligned loads and stores”
40	rs1	rs2	offset			sb	store byte
41	rs1	rs2	offset			sh	store halfword
42	rs1	rs2	offset			swl	“Store word left”, see section on “Unaligned loads and stores”
43	rs1	rs2	offset			sw	store word
46	rs1	rs2	offset			swr	“Store word right”, see section on “Unaligned loads and stores”
49	rs	fs	offset			swc1	Store word from FP register fs
57	rs	fd	offset			lwc1	Load word into FP register fd

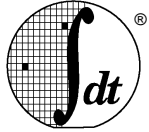

## **FPU Instruction Set Details**

This section documents the instructions for the floating-point unit (FPU) in MIPS processors. It contains some descriptive material at the beginning, a detailed description for each instruction in alphabetic order, and an instruction opcode encoding table at the end of the section.

The descriptive material describes the FPU instruction categories, the instruction encoding formats, the valid operands for FPU computational instructions, compare and condition values, FPU use of the coprocessor registers, and a description of the notation used for the detailed instruction description.

This section does not describe the operation of floating-point arithmetic, the exception conditions within FP arithmetic, the exception mechanism of the FPU, or the handling of these FP exceptions.

### **FPU Instructions**

The floating-point unit (FPU) is implemented as Coprocessor unit 1 (CP1) within the MIPS architecture. A floating-point instruction needs access to coprocessor 1 to execute; if CP1 is not enabled, an FP instruction will cause a Coprocessor Unusable exception. The FPU has a load/store architecture. All computations are done on data held in registers, and data is transferred between registers and the rest of the system with dedicated load, store, and move instructions.

The FPU instructions fall into the following categories:

- Data Transfer
- Conversion
- Arithmetic
- Register-to-Register Data Movement
- Branch

### **Floating-Point Data Transfer**

All movement of data between the floating-point coprocessor general registers and the rest of the system is accomplished by:

- Load memory to CP1 general register
- Store CP1 general register to memory
- Move CPU register to CP1 general register
- Move CP1 general register to CPU register

These operations are unformatted; no format conversions are performed and, therefore, no floating-point exceptions can occur.

The coprocessor also contains floating-point control registers. The only data movement operations supported for them are:

- Copy CPU register to FPU control register
- Copy FPU control register to CPU register

### **Floating-Point Conversions**

The floating-point unit has instructions to convert among the operand types as well as operations which combine conversion with rounding using a particular rounding mode. The conversion operations are:

- fixed-point to floating-point
- floating to fixed
- floating to floating (of another size)

### Floating-Point Arithmetic

The floating-point arithmetic instructions are:

- add
- subtract
- multiply
- divide
- absolute value
- negate
- compare

All operations satisfy the requirements of IEEE Standard 754 requirements for accuracy; a result which is identical to an infinite-precision result rounded to the specified format, using the current rounding mode.

### Floating-Point Register-to-Register Move

There are FPU instructions to move formatted operands among registers:

- FP move
- FP register move-conditional on FP condition code
- FP register move-conditional on CPU register value
- CPU register move-conditional on FP condition code

### Floating-Point Branch

The FP compare instruction produces a condition code. The FPU has instructions to conditionally branch on the FP condition.

### FP Computational Instructions and Valid Operands

The Floating-point unit computational instructions operate on structured data and the operands can have one of several operand *formats*. The format of the operands, and perhaps the result, for an instruction is specified by either the 5-bit *fmt* field or 3-bit *fmt3* field in the instruction encoding; decoding for these fields is shown in Table B.7.

<i>fmt</i>	<i>fmt3</i>	Mnemonic	Size	Format
0-15	-	Reserved		
16	0	S	single	Binary floating-point
17	1	D	double	Binary floating-point
18	2	Reserved for E	extended	Reserved for Extended binary floating-point
19	3	Reserved for Q	quad	Reserved for Quad binary floating-point.
20	4	W	single	32-bit binary fixed-point
21	5	Reserved for L	longword	64-bit binary fixed-point
22-31	6-7	Reserved		

**Table B.7. Format Field Decoding**

A particular operation is valid only for operands of certain formats.



## FP Compare and Condition values

The coprocessor branch on condition true/false instructions can be used to logically negate any predicate. Thus, the 32 possible conditions require only 16 distinct comparisons, as shown below.

Condition		Code	Compare Relations				Invalid Operation Exception If Unordered
Branch Mnemonic			Greater Than	Less Than	Equal	Unordered	
True	False						
F	T	0	F	F	F	F	No
UN	OR	1	F	F	F	T	No
EQ	NEQ	2	F	F	T	F	No
UEQ	OGL	3	F	F	T	T	No
OLT	UGE	4	F	T	F	F	No
ULT	OGE	5	F	T	F	T	No
OLE	UGT	6	F	T	T	F	No
ULE	OGT	7	F	T	T	T	No
SF	ST	8	F	F	F	F	Yes
NGLE	GLE	9	F	F	F	T	Yes
SEQ	SNE	10	F	F	T	F	Yes
NGL	GL	11	F	F	T	T	Yes
LT	NLT	12	F	T	F	F	Yes
NGE	GE	13	F	T	F	T	Yes
LE	NLE	14	F	T	T	F	Yes
NGT	GT	15	F	T	T	T	Yes

**Table B.8. Logical Negation of Predicates by Condition True/False**

## FPU Register Specifiers

The data transfer instructions and the computational instructions view the Coprocessor 1 general registers and the data in them in different ways. This section describes the general registers in the coprocessor, how data transfer instructions transfer operand data, how the FPU uses registers to hold the different types and sizes of operands, and how the FPU computational instructions specify operands.

The **CP1 register** is the fundamental addressable unit in the coprocessor. All instructions that refer to the CP1 registers use the 32 CP1 general register numbers as register specifiers in the instruction encoding. Some register numbers are not valid specifiers for some instructions; this is discussed below.

The data transfer operations consist of memory load/store and move to/from CPU register instructions. These instructions, with one exception noted below, transfer unformatted data to/from a single CP1 register. Most of the transfer instructions are the generic load/store/move instructions used with all coprocessors and they do not have any special operation for CP1.

The FPU operates on operands of different lengths. Some operands exceed the CP1 general register size, so the FPU computational instructions use the CP1 general registers in a structured way. If the FPU operand exceeds the CP1 register size, a set of adjacent CP1 general registers are used to hold the data for the operand. All multi-register

operands must be in “aligned” sets of registers; an operand that requires two registers must be in an even register and the next-higher odd register. When the FPU operand is in a set of CP1 registers, the lowest-numbered register in the set is used as the **FPU operand specifier** or **FPU register specifier** in the instruction encoding.

The sets of registers are structured in a big-endian order for both big and little endian processors. The least-significant portion of the operand is put into the lowest-numbered CP1 register in the set, and the most-significant is put into the highest-numbered register.

### 32-bit CP1 registers

All 32-bit processors have 32-bit CP1 registers. The 64-bit processors have a 32-bit-CP1-register emulation mode in which CP1 appears to possess 32-bit registers. The primary FP data type is double floating-point, which requires 64 bits of register space. For simplicity in implementation, the minimum FPU operand size is a doubleword in the CP1 register file. Operands of type word size (W and S), are placed into the low word of the doubleword.

The MIPS I version of the architecture has only word load/store/move instructions. To transfer anything but a W or S operand takes multiple instructions that each reference one of the 32-bit CP1 general registers. The load/store/move instructions use all the CP1 register numbers as specifiers because they do not refer to formatted FP operands.

Valid specifiers	32-bit CP1 register use and significance by operand type			
	W,S		L, D	
	unused / undefined	data	most	least
0	1	0	1	0
2	3	2	3	2
4	5	4	5	4

**Table B.9. Valid FP Operand Specifiers with 32-bit Coprocessor 1 Registers.**

**FPU Register Access for 32-bit CP1 Registers**

```

value <-- ValueFPR(fpr, fmt)/* undefined for odd fpr */
case fmt of
  S, W:
    value <-- FGR[fpr+0]
  D:
    /* undefined for fpr not even */
    value <-- FGR[fpr+1] || FGR[fpr+0]
end

```

```

StoreFPR(fpr, fmt, value):/* undefined for odd fpr */
case fmt of
  S, W:
    FGR[fpr+1] <-- undefined
    FGR[fpr+0] <-- value
  D:
    FGR[fpr+1] <-- value63...32
    FGR[fpr+0] <-- value31...0
end

```

NOTE: The notation “FGR[fpr]” is either the physical 32-bit register or the logical 32-bit register for a 64-bit processor in 32-bit register emulation mode. It does not imply a specific mechanism for the 32-bit register

**Instruction Notation Conventions**

For the FPU instruction detail documentation, all variable subfields in an instruction format (such as *fs*, *ft*, *immediate*, and so on) are shown in lower-case. The instruction name (such as ADD, SUB, and so on) is shown in upper-case.

For the sake of clarity, an alias may be used for a variable subfield in the formats of specific instructions. For example, *rs = base* is used in the format for load and store instructions. Such an alias is always lower case, since it refers to a variable subfield.

In some instructions, the instruction subfields *op* and *function* can have constant 6-bit values. When reference is made to these instructions, upper-case mnemonics are used. For instance, in the floating-point ADD instruction we use *op* = COP1 and *function* = ADD. In other cases, a single field has both fixed and variable subfields, so the name contains both upper and lower case characters. Bit encodings for mnemonics are shown at the end of this section, and are also included with each individual instruction.

The instruction description includes an *Operation* section that describes the operation of the instruction in a pseudocode resembling a programming language.

In the instruction description examples that follow, the *Operation* section describes the operation performed by each instruction using a high-level language notation.

## Load and Store Memory

In the load and store operation descriptions, the functions listed below are used to summarize the handling of virtual addresses and physical memory.

Function	Meaning
AddressTranslation	Determines the physical address given the virtual address. The function fails and an exception is taken if the required translation is not present in the TLB ("E" versions only).
LoadMemory	Uses the cache and main memory to find the contents of the word containing the specified physical address. The low-order two bits of the address and the <i>Access Type</i> field indicates which of each of the four bytes within the data word need to be returned. If the cache is enabled for this access, the entire word is returned and loaded into the cache.
StoreMemory	Uses the cache, write buffer, and main memory to store the word or part of word specified as data in the word containing the specified physical address. The low-order two bits of the address and the <i>Access Type</i> field indicates which of each of the four bytes within the data word should be stored.

**Table B.10. Load and Store Common Functions**

All coprocessor loads and stores reference aligned-word data items. Thus, for word loads and stores, the access type field is always WORD, and the low-order two bits of the address must always be zero.

Regardless of byte-numbering order (endianness), the address specifies that byte which has the smallest byte-address in the addressed field. For a big-endian machine, this is the leftmost byte; for a little-endian machine, this is the rightmost byte.

## Instruction Descriptions

The FP instructions are described in detail in alphabetic order. Each page contains the following information for the instruction:

- Instruction mnemonic and name
- Assembler format
- Description of the instruction
- Operation of the instruction described in pseudocode.
- Exceptions that the instruction can cause
- FP exception conditions that the instruction can cause (as Floating-Point Exceptions)

# ABS.fmt      Floating-Point Absolute Value      ABS.fmt

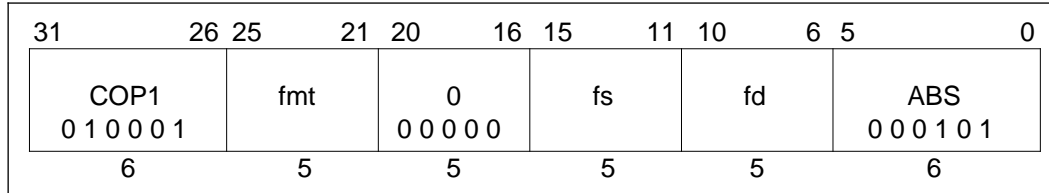
**Format:**

ABS.fmt fd, fs

**Description:**

$fd \leftarrow |fs|$

The contents of the FPU register specified by *fs* are interpreted in the specified format and the arithmetic absolute value is taken. The result is placed in the floating-point register specified by *fd*.

The absolute value operation is arithmetic; a NaN operand signals invalid operation.

This instruction is valid only for single- and double-precision floating-point formats.

The fields *fs* and *fd* must specify valid operand registers for the type *fmt* and the logical size of coprocessor 1 general registers. If they are not valid specifiers, the result is undefined.

**Operation:**

T:    StoreFPR(fd, fmt, AbsoluteValue(ValueFPR(fs, fmt)))
---

**Exceptions:**

Coprocessor unusable exception

Coprocessor exception trap

**Floating-Point Exceptions:**

Unimplemented operation exception

Invalid operation exception

# ADD.fmt      Floating-Point Add      ADD.fmt

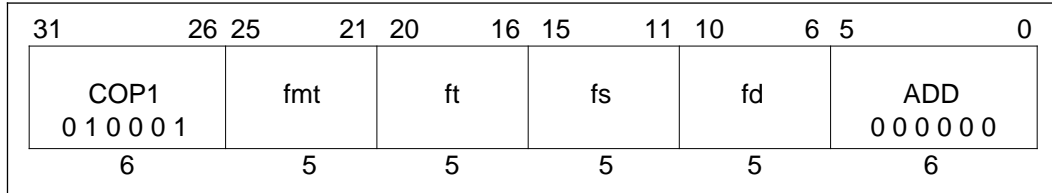

## Format:

ADD.fmt fd, fs, ft

## Description:

$fd \leftarrow fs + ft$

The contents of the FPU registers specified by *fs* and *ft* are interpreted in the specified format and arithmetically added. The result is rounded as if calculated to infinite precision and then rounded to the specified format (*fmt*), according to the current rounding mode. The result is placed in the floating-point register (*FPR*) specified by *fd*.

The fields *fs*, *ft*, and *fd* must specify valid operand registers, given the logical size of coprocessor 1 general registers, for the type *fmt*. If they are not valid specifiers, the result is undefined.

## Operation:

T:    StoreFPR (fd, fmt, ValueFPR(fs, fmt) + ValueFPR(ft, fmt))

## Exceptions:

Coprocessor unusable exception  
Floating-Point exception

## Floating-Point Exceptions:

Unimplemented operation exception  
Invalid operation exception  
Inexact exception  
Overflow exception  
Underflow exception

# BC1F Branch On Floating-Point False BC1F

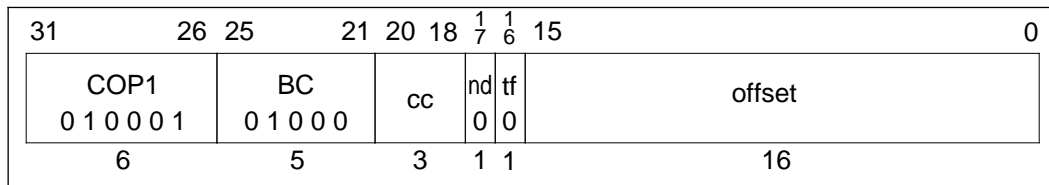

## Format:

BC1F offset (cc=0)

## Description:

A branch target address is computed from the sum of the address of the instruction in the delay slot, and the 16-bit *offset*, shifted left two bits and sign-extended. If the contents of the floating point condition code specified by *cc* are zero (equal to the value of the *tf* field), the target address is branched to with a delay of one instruction.

The condition codes are set by the floating-point compare instruction.

MIPS I specifies a single floating-point condition that is available as the coprocessor 1 condition signal (Cp1Cond) and the C bit in the FP *Control and Status* register. This instruction always tests the Cp1Cond signal. The first assembler format instruction shown, with an implied *cc* field of zero, is the only form allowed for processors that implement the MIPS I instruction.

This instruction has a scheduling restriction. The condition information is sampled during the preceding instruction and there must be at least one instruction between this branch instruction and the compare instruction that changes the condition code. Hardware does not enforce this restriction.

## Operation:

MIPS I has a single condition signal, the COprocessor Condition signal Cp-Cond(1).

T-1: condition  $\leftarrow$  COC[1] = tf  
 T: target  $\leftarrow$  (offset<sub>15</sub>)<sup>GPRlen-(16+2)</sup> || offset || 0<sup>2</sup>  
 T+1: if condition then  
       PC  $\leftarrow$  PC + target

## Exceptions:

Coprocessor unusable exception  
 Floating-Point exception

## Floating-Point Exceptions:

Unimplemented operation exception

# BC1T Branch On Floating Point True BC1T

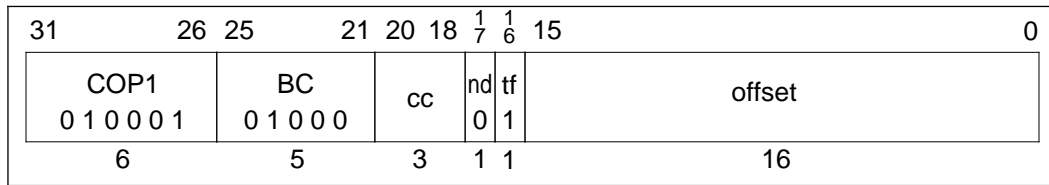

## Format:

BC1T offset (cc=0)

## Description:

A branch target address is computed from the sum of the address of the instruction in the delay slot, and the 16-bit *offset*, shifted left two bits and sign-extended. If the contents of the floating point condition code specified by *cc* are one (equal to the value of the *tf* field), the target address is branched to with a delay of one instruction.

The condition codes are set by the floating-point compare instruction.

MIPS I specifies a single floating-point condition that is available as the coprocessor 1 condition signal (Cp1Cond) and the C bit in the FP *Control and Status* register. This instruction always tests the Cp1Cond signal. The first assembler format instruction shown, with an implied *cc* field of zero, is the only form allowed for processors that implement the MIPS I instruction.

This instruction has a scheduling restriction. The condition information is sampled during the preceding instruction and there must be at least one instruction between this branch instruction and the compare instruction that changes the condition code. Hardware does not enforce this restriction.

## Operation:

MIPS I has a single condition signal, the COprocessor Condition signal COC.

T-1: condition  $\leftarrow$  COC[1] = tf  
 T: target  $\leftarrow$  (offset<sub>15</sub>)<sup>GPRlen-(16+2)</sup> || offset || 0<sup>2</sup>  
 T+1: if condition then  
           PC  $\leftarrow$  PC + target

## Exceptions:

Coprocessor unusable exception

Floating-Point exception

## Floating-Point Exceptions:

Unimplemented operation exception



# C.cond.fmt Floating-Point Compare C.cond.fmt

31	26	25	21	20	16	15	11	10	8	7	6	5	4	3	0
COP1						fmt		ft		fs		cc	0	FC	
010001												00	11	cond	
6						5		5		5		3	2	2	4

## Format:

C.cond.fmt fs, ft (cc=0)

## Description:

The contents of the floating-point registers specified by *fs* and *ft* are interpreted in the specified format and arithmetically compared. A result is determined based on the comparison and the condition, *cond*, specified in the instruction. The result is stored in the condition code specified by *cc*. If one of the values is a “Not a Number,” and the high-order bit of the condition field is set, an invalid operation trap is taken.

MIPS I specifies a single floating-point condition that is available as the coprocessor 1 condition signal (Cp1Cond) and as the C bit in the FP *Control and Status* register. This instruction always sets the Cp1Cond signal. The first assembler format instruction shown, with an implied *cc* field of zero, is the only form allowed for processors that implement the MIPS I instruction.

Comparisons are exact and neither overflow nor underflow. Four mutually exclusive relations are possible results: “less than,” “equal,” “greater than,” and “unordered.” The last case arises when one or both of the operands are NaN; every NaN compares “unordered” with everything, including itself. Comparisons ignore the sign of zero, so +0 “equals” -0.

This instruction has a timing restriction. The contents of the destination condition code specified by *cc*, or the Cp1Cond signal is immediately available only within the floating-point unit. A one-instruction delay is provided to propagate the condition code to the remainder of the processor. The value of the condition code is undefined during this one-instruction delay. No hardware interlock is provided to detect this hazard.

The implications for compiler code scheduling is that a compare instruction may be immediately followed by a dependent floating-point conditional move instruction, but may not be immediately followed by a dependent branch on floating-point coprocessor condition instruction or a dependent integer conditional move instruction. Note that this restriction applies only to the particular condition code specified by *cc*; the other condition codes are unaffected.

The fields *fs* and *ft* must specify valid operand registers for the type *fmt* and the logical size of coprocessor 1 general registers. If they are not valid specifiers, the result is undefined.

# C.cond.fmt Floating-Point Compare (Continued) C.cond.fmt

## Operation:

```

if NaN(ValueFPR(fs, fmt)) or NaN(ValueFPR(ft, fmt)) then
    less ← false
    equal ← false
    unordered ← true
    if cond3 then
        signal InvalidOperationException
    endif
else
    less ← ValueFPR(fs, fmt) < ValueFPR(ft, fmt)
    equal ← ValueFPR(fs, fmt) = ValueFPR(ft, fmt)
    unordered ← false
endif
condition ← (cond2 and less) or (cond1 and equal) or
             cond0 and unordered
COC[1] ← condition

```

## Exceptions:

- Coprocessor unusable exception
- Floating-Point exception

## Floating-Point Exceptions:

- Unimplemented operation exception
- Invalid operation exception

# CFC1      Move Control Word from Floating-Point (CP1)      CFC1

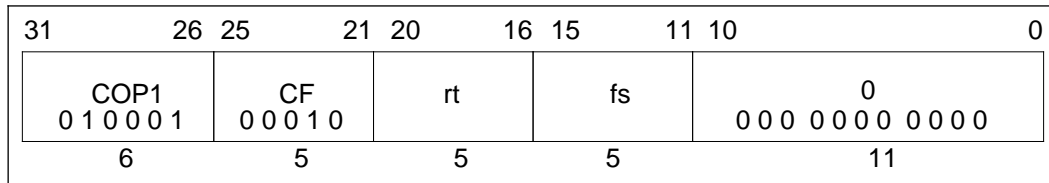
**Format:**CFC1 *rt*, *fs***Description:**

The contents of the FPU control register *fs* are loaded into general register *rt*.

This operation is only defined when *fs* equals 0 or 31.

The contents of general register *rt* are undefined for time *T* of the instruction immediately following this load instruction.

**Operation:**

T:    temp ← FCR[*fs*]  
 T+1: GPR[*rt*] ← (temp<sub>31</sub>)<sup>GPRlen-32</sup> || temp

**Exceptions:**

Coprocessor unusable exception

# CTC1      Move Control Word to Floating-Point (CP1)      CTC1

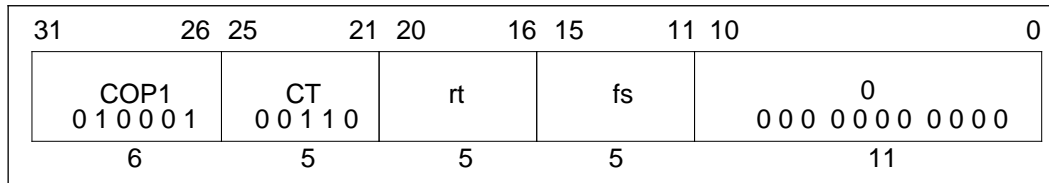
**Format:**

CTC1 rt, fs

**Description:**

The contents of general register *rt* are loaded into FPU control register *fs*. This operation is only defined when *fs* equals 0 or 31.

Writing to *Control Register 31*, the floating-point *Control/Status* register, causes an interrupt or exception if any cause bit and its corresponding enable bit are both set. The register will be written before the exception occurs. The contents of floating-point control register *fs* are undefined for time *T* of the instruction immediately following this load instruction.

**Operation:**

```

T:   temp ← GPR[rt]31...0
T+1: FCR[fs] ← temp
      COC[1] ← FCR[31]23

```

**Exceptions:**

Coprocessor unusable exception  
 Floating-Point exception

**Floating-Point Exceptions:**

Unimplemented operation exception  
 Invalid operation exception  
 Division by zero exception  
 Inexact exception  
 Overflow exception  
 Underflow exception

# CVT.D.fmt      Floating-Point Convert to Double      CVT.D.fmt Floating-Point Format

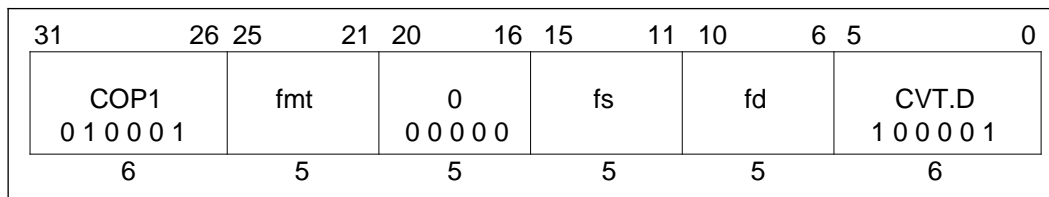
**Format:**CVT.D.fmt *fd*, *fs***Description:**

The contents of the floating-point register specified by *fs* is interpreted in the specified source format, *fmt*, and arithmetically converted to the double floating-point format. The result is placed in the floating-point register specified by *fd*.

This instruction is valid only for conversions from single floating-point format or 32-bit fixed-point format.

If *fmt* specifies the single floating-point or single fixed-point format then the operation is exact.

The field *fs*, and *fd* must specify valid operand registers given the logical size of coprocessor 1 general registers; *fs* for the type *fmt* and *fd* for double floating-point. If they are not valid specifiers, the result is undefined.

**Operation:**

T:    StoreFPR (*fd*, D, ConvertFmt(ValueFPR(*fs*, *fmt*), *fmt*, D))

**Exceptions:**

Coprocessor unusable exception

Floating-Point exception

**Floating-Point Exceptions:**

Invalid operation exception

Unimplemented operation exception

Inexact exception

Overflow exception

Underflow exception

# CVT.S.fmt    Floating-Point    CVT.S.fmt

## Convert to Single    Floating-Point Format

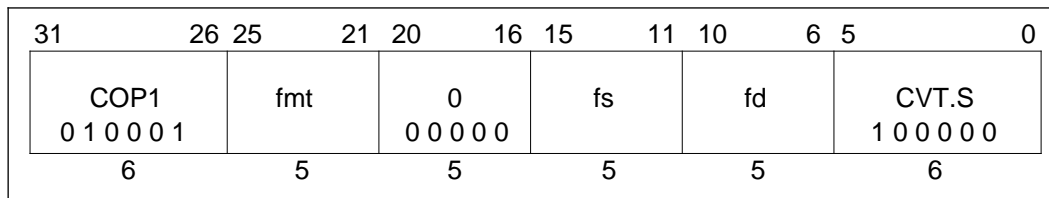

### Format:

CVT.S.fmt *fd*, *fs*

### Description:

The contents of the floating-point register specified by *fs* are interpreted in the specified source format, *fmt*, and arithmetically converted to the single binary floating-point format. The result is placed in the floating-point register specified by *fd*. Rounding occurs according to the currently specified rounding mode.

This instruction is valid only for conversions from double floating-point format, or from 32-bit fixed-point format.

The field *fs*, and *fd* must specify valid operand registers given the logical size of coprocessor 1 general registers; *fs* for the type *fmt* and *fd* for single floating-point. If they are not valid specifiers, the result is undefined.

### Operation:

T:    StoreFPR( <i>fd</i> , S, ConvertFmt(ValueFPR( <i>fs</i> , <i>fmt</i> ), <i>fmt</i> , S))
--

### Exceptions:

Coprocessor unusable exception  
Floating-Point exception

### Floating-Point Exceptions:

Invalid operation exception  
Unimplemented operation exception  
Inexact exception  
Overflow exception  
Underflow exception

# CVT.W.fmt    Floating-Point    CVT.W.fmt Convert to Fixed-Point Format

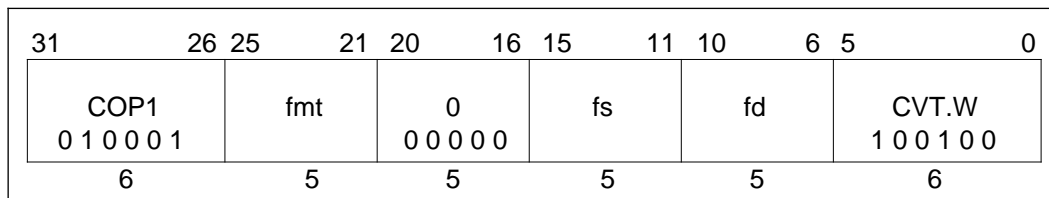

## Format:

CVT.W.fmt fd, fs

## Description:

The contents of the floating-point register specified by *fs* are interpreted in the specified source format, *fmt*, and arithmetically converted to the single-word fixed-point format. The result is placed in the floating-point register specified by *fd*.

This instruction is valid only for conversion from a single- or double-precision floating-point formats.

The field *fs*, and *fd* must specify valid operand registers given the logical size of coprocessor 1 general registers; *fs* for the type *fmt* and *fd* for single-word fixed-point. If they are not valid specifiers, the result is undefined.

When the source operand is an Infinity or NaN, or the correctly rounded integer result is outside the range of the single-word fixed-point result type ( $-2^{31}$  to  $2^{31}-1$ ), the Invalid operation exception is raised. If the Invalid operation is not enabled then no exception is taken and the largest positive result ( $2^{31}-1$ ) is returned.

## Operation:

T:    StoreFPR(fd, W, ConvertFmt(ValueFPR(fs, fmt), fmt, W))
--

## Exceptions:

Coprocessor unusable exception  
Floating-Point exception

## Floating-Point Exceptions:

Invalid operation exception  
Unimplemented operation exception  
Inexact exception  
Overflow exception

# DIV.fmt      Floating-Point Divide      DIV.fmt

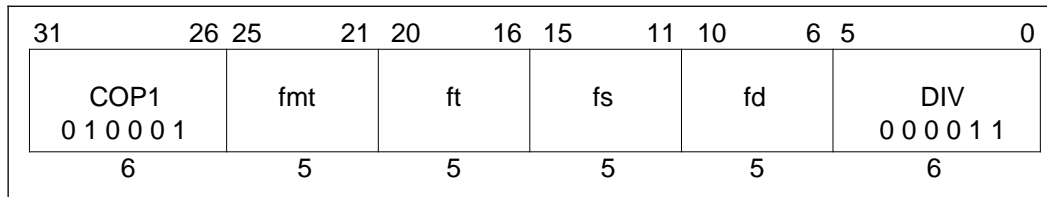
**Format:**

DIV.fmt *fd*, *fs*, *ft*

**Description:**

$fd \leftarrow fs / ft$

The contents of the floating-point registers specified by *fs* and *ft* are interpreted in the specified *format* and *fs* is arithmetically divided by *ft*. The result is rounded as if calculated to infinite precision and then rounded to the specified format, according to the current rounding mode. The result is placed in the floating-point register specified by *fd*.

This instruction is valid for only single or double precision floating-point formats.

The fields *fs*, *ft*, and *fd* must specify valid operand registers, given the logical size of coprocessor 1 general registers, for the type *fmt*. If they are not valid specifiers, the result is undefined.

**Operation:**

T:      StoreFPR ( <i>fd</i> , <i>fmt</i> , ValueFPR( <i>fs</i> , <i>fmt</i> )/ValueFPR( <i>ft</i> , <i>fmt</i> ))
--

**Exceptions:**

Coprocessor unusable exception  
Floating-Point exception

**Floating-Point Exceptions:**

Unimplemented operation exception	Invalid operation exception
Division-by-zero exception	Inexact exception
Overflow exception	Underflow exception





# MFC1 Move Word from Floating-Point (CP1) MFC1

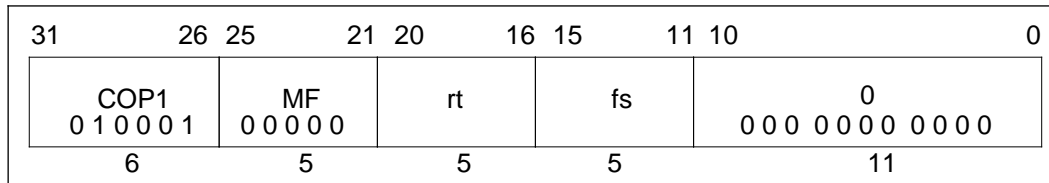

## Format:

MFC1 *rt*, *fs*

## Description:

The contents of register *fs* from the floating-point coprocessor are stored into processor register *rt*.

The contents of register *rt* are undefined for time *T* of the instruction immediately following this load instruction.

## Operation:

<p>T:     data ← CPR[1, <i>fs</i>];  T+1:   GPR[<i>rt</i>] ← data</p>
---

## Exceptions:

Coprocessor unusable exception

# MOV.fmt Floating-Point Move MOV.fmt

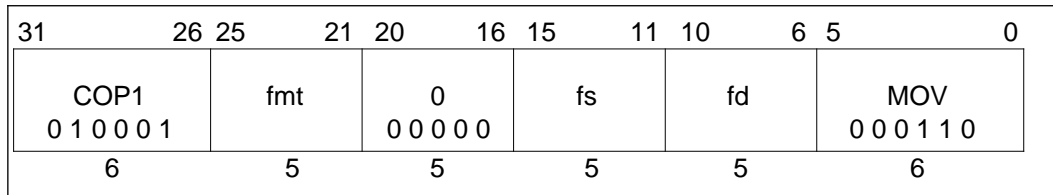

## Format:

MOV.fmt fd, fs

## Description:

$fd \leftarrow fs$

The contents of the FPU register specified by *fs* are interpreted in the specified *format* and are copied into the FPU register specified by *fd*.

The move is non-arithmetic; it causes no IEEE 754 exceptions.

This instruction is valid only for single- or double-precision floating-point formats.

The fields *fs* and *fd* must specify valid operand registers for the type *fmt* and the logical size of coprocessor 1 general registers. If they are not valid specifiers, the result is undefined.

## Operation:

T: StoreFPR(fd, fmt, ValueFPR(fs, fmt))

## Exceptions:

Coprocessor unusable exception

Floating-Point exception

## Floating-Point Exceptions:

Unimplemented operation exception

# MTC1 Move Word to Floating-Point (CP1) MTC1

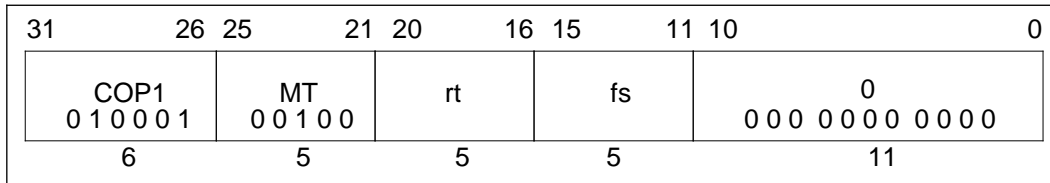

## Format:

MTC1 *rt*, *fs*

## Description:

The contents of register *rt* are loaded into the FPU general register at location *fs*.

The contents of floating-point register *fs* is undefined for time *T* of the instruction immediately following this load instruction.

## Operation:

<p>T:     data ← GPR[<i>rt</i>]  T+1:   CPR[1, <i>fs</i>] ← data</p>
--

## Exceptions:

Coprocessor unusable exception

# MUL.fmt Floating-Point Multiply MUL.fmt

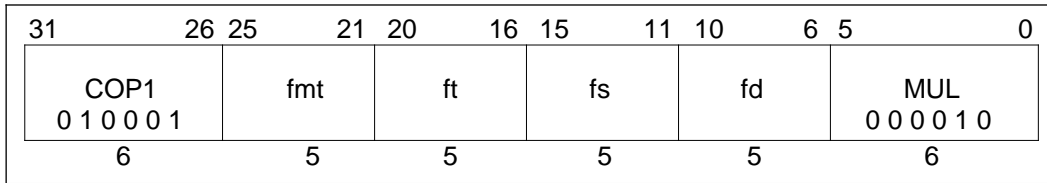

## Format:

MUL.fmt fd, fs, ft

## Description:

$fd \leftarrow fs \times ft$

The contents of the floating-point registers specified by *fs* and *ft* are interpreted in the specified *format* and arithmetically multiplied. The result is rounded as if calculated to infinite precision and then rounded to the specified *format*, according to the current rounding mode. The result is placed in the floating-point register specified by *fd*.

This instruction is valid only for single- or double-precision floating-point formats.

The fields *fs*, *ft*, and *fd* must specify valid operand registers, given the logical size of coprocessor 1 general registers, for the type *fmt*. If they are not valid specifiers, the result is undefined.

## Operation:

T:   StoreFPR (fd, fmt, ValueFPR(fs, fmt) * ValueFPR(ft, fmt))
--

## Exceptions:

Coprocessor unusable exception  
Floating-Point exception

## Floating-Point Exceptions:

Unimplemented operation exception  
Invalid operation exception  
Inexact exception  
Overflow exception  
Underflow exception

# NEG.fmt Floating-Point Negate NEG.fmt

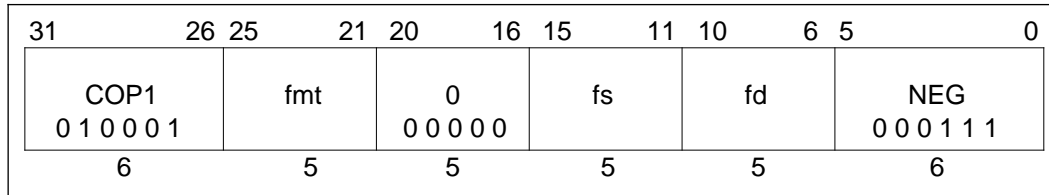

## Format:

NEG.fmt fd, fs

## Description:

$fd \leftarrow -fs$

The contents of the FPU register specified by *fs* are interpreted in the specified *format* and the arithmetic negation is taken (polarity of the sign-bit is changed). The result is placed in the FPU register specified by *fd*.

The negate operation is arithmetic; an NaN operand signals invalid operation.

The fields *fs* and *fd* must specify valid operand registers for the type *fmt* and the logical size of coprocessor 1 general registers. If they are not valid specifiers, the result is undefined.

## Operation:

T: StoreFPR(fd, fmt, Negate(ValueFPR(fs, fmt)))
---

## Exceptions:

Coprocessor unusable exception  
Floating-Point exception

## Floating-Point Exceptions:

Unimplemented operation exception  
Invalid operation exception

# SUB.fmt Floating-Point Subtract SUB.fmt

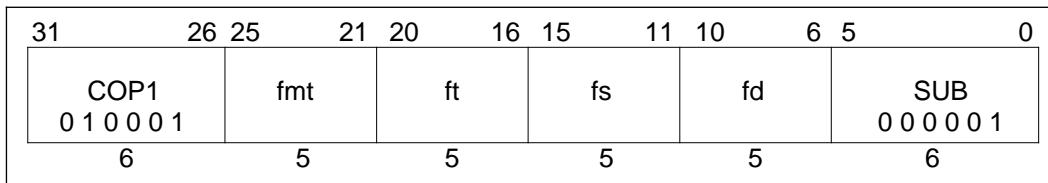

## Format:

SUB.fmt *fd*, *fs*, *ft*

## Description:

The contents of the floating-point registers specified by *fs* and *ft* are interpreted in the specified *format* and arithmetically subtracted. The result is rounded as if calculated to infinite precision and then rounded to the specified *format*, according to the current rounding mode. The result is placed in the floating-point register specified by *fd*.

This instruction is valid only for single- or double-precision floating-point formats.

The fields *fs*, *ft*, and *fd* must specify valid operand registers, given the logical size of coprocessor 1 general registers, for the type *fmt*. If they are not valid specifiers, the result is undefined.

## Operation:

T: StoreFPR ( <i>fd</i> , <i>fmt</i> , ValueFPR( <i>fs</i> , <i>fmt</i> ) – ValueFPR( <i>ft</i> , <i>fmt</i> ))
---

## Exceptions:

Coprocessor unusable exception  
 Floating-Point exception

## Floating-Point Exceptions:

Unimplemented operation exception  
 Invalid operation exception  
 Inexact exception  
 Overflow exception  
 Underflow exception

# SWC1      Store Word      SWC1

## from Floating-Point (CP1)

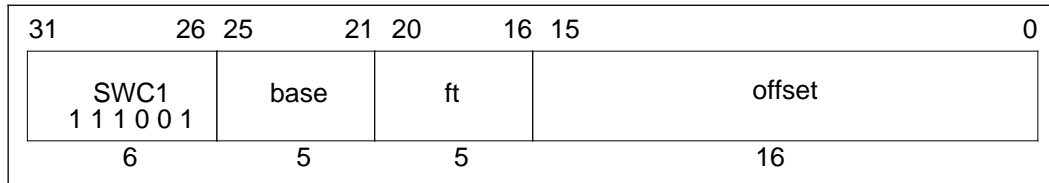
**Format:**

SWC1 ft, offset(base)

**Description:**

The 16-bit *offset* is sign-extended and added to the contents of general register *base* to form an unsigned effective address. The word from floating-point (coprocessor 1) general register *ft* is stored at the memory location specified by the effective address.

The effective address must be word-aligned. If either of the two least-significant bits of the effective address is non-zero, an address error exception occurs.

**Operation:**

T:      $vAddr \leftarrow ((offset_{15})^{GPRlen-16} || offset_{15..0}) + GPR[base]$   
         $(pAddr, uncached) \leftarrow AddressTranslation(vAddr, DATA)$   
         $data \leftarrow CPR[1, ft]$   
        StoreMemory(uncached, WORD, data, pAddr, vAddr, DATA)

**Exceptions:**

- Coprocessor unusable
- TLB refill exception
- TLB invalid exception
- TLB modification exception
- Bus error exception
- Address error exception



## FPA Instruction Set Summary

<i>Instr Fields</i>						<i>Asm</i>	<i>Description</i>
<i>op</i>					<i>func</i>		
<i>31-26</i>	<i>25-21</i>	<i>20-16</i>	<i>15-11</i>	<i>10-6</i>	<i>5-0</i>		
<b>Single Precision Arithmetic Instructions</b>							
17	16	fs2	fs1	fd	0	add.s	3-operand single precision add.
17	16	fs2	fs1	fd	1	sub.s	3-operand single precision subtraction.
17	16	fs2	fs1	fd	2	mul.s	3-operand single precision multiply.
17	16	fs2	fs1	fd	3	div.s	3-operand single precision divide.
17	16	0	fs	fd	5	abs.s	Single-precision absolute value of fs is placed into fd.
17	16	0	fs	fd	6	mov.s	Single precision move of value in fs into fd.
<b>Format Conversion</b>							
17	17	0	fs	fd	32	cvt.s.d	Convert a double precision value to single precision.
17	16	0	fs	fd	33	cvt.d.s	Convert a single precision value to double precision.
17	20	0	fs	fd	32	cvt.s.w	Convert an integer "word" value to single precision.
17	20	0	fs	fd	33	cvt.d.w	Convert an integer "word" value to double precision.
17	16	0	fs	fd	36	cvt.w.s	Convert a single precision value to a word value.
17	17	0	fs	fd	36	cvt.w.d	Convert a double precision value to a word value
<b>Single Precision Comparison Operations: No Invalid Operation Exception taken for Unordered Operands</b>							
17	16	fs1	fs2	0	48	c.f.s	Result will be false
17	16	fs1	fs2	0	49	c.un.s	True if fp values are "unordered"
17	16	fs1	fs2	0	50	c.eq.s	True if the two values are equal
17	16	fs1	fs2	0	51	c.ueq.s	True if equal or unordered.
17	16	fs1	fs2	0	51	c.ueq.s	True if equal or unordered.
17	16	fs1	fs2	0	52	c.olt.s	True if ordered and less than
17	16	fs1	fs2	0	53	c.ult.s	True if unordered or less than
17	16	fs1	fs2	0	54	c.ole.s	Ordered and (equal or less than)

<i>Instr Fields</i>						<i>Asm</i>	<i>Description</i>
<i>op</i>					<i>func</i>		
<b>31-26</b>	<b>25-21</b>	<b>20-16</b>	<b>15-11</b>	<b>10-6</b>	<b>5-0</b>		
17	16	fs1	fs2	0	55	c.ule.s	Unordered or less than or equal.
<b>Single Precision Comparison Operations: Invalid Operation Exception Signalled for Unordered Operands</b>							
17	16	fs1	fs2	0	56	c.sf.s	Result will be false
17	16	fs1	fs2	0	57	c.ngle.s	True if fp values are “unor- dered”
17	16	fs1	fs2	0	58	c.seq.s	True if the two values are equal
17	16	fs1	fs2	0	59	c.ngl.s	True if equal or unordered.
17	16	fs1	fs2	0	60	c.lt.s	True if equal or unordered.
17	16	fs1	fs2	0	61	c.nge.s	True if ordered and less than
17	16	fs1	fs2	0	62	c.le.s	True if unordered or less than
17	16	fs1	fs2	0	63	c.ngt.s	Ordered and (equal or less than)
<b>Double Precision Comparison Operations: No Invalid Operation Exception taken for Unordered Operands</b>							
17	17	fs1	fs2	0	48	c.f.d	Result will be false
17	17	fs1	fs2	0	49	c.un.d	True if fp values are “unor- dered”
17	17	fs1	fs2	0	50	c.eq.d	True if the two values are equal
17	17	fs1	fs2	0	51	c.ueq.d	True if equal or unordered.
17	17	fs1	fs2	0	51	c.ueq.d	True if equal or unordered.
17	17	fs1	fs2	0	52	c.olt.d	True if ordered and less than
17	17	fs1	fs2	0	53	c.ult.d	True if unordered or less than
17	17	fs1	fs2	0	54	c.ole.d	Ordered and (equal or less than)
17	17	fs1	fs2	0	55	c.ule.d	Unordered or less than or equal.
<b>Double Precision Comparison Operations: Invalid Operation Exception Signalled for Unordered Operands</b>							
17	17	fs1	fs2	0	56	c.sf.d	Result will be false
17	17	fs1	fs2	0	57	c.ngle.d	True if fp values are “unor- dered”
17	17	fs1	fs2	0	58	c.seq.d	True if the two values are equal
17	17	fs1	fs2	0	59	c.ngl.d	True if equal or unordered.

<b><i>Instr Fields</i></b>						<b><i>Asm</i></b>	<b><i>Description</i></b>
<b><i>op</i></b>					<b><i>func</i></b>		
<b><i>31-26</i></b>	<b><i>25-21</i></b>	<b><i>20-16</i></b>	<b><i>15-11</i></b>	<b><i>10-6</i></b>	<b><i>5-0</i></b>		
17	17	fs1	fs2	0	60	c.lt.d	True if equal or unordered.
17	17	fs1	fs2	0	61	c.ng.e.d	True if ordered and less than
17	17	fs1	fs2	0	62	c.le.d	True if unordered or less than
17	17	fs1	fs2	0	63	c.ngt.d	Ordered and (equal or less than)
<b>Double Precision Arithmetic Instructions</b>							
17	17	fs2	fs1	fd	0	add.d	3-operand double precision add.
17	17	fs2	fs1	fd	1	sub.d	3-operand double precision subtraction.
17	17	fs2	fs1	fd	2	mul.d	3-operand double precision multiply.
17	17	fs2	fs1	fd	3	div.d	3-operand double precision divide.
17	17	0	fs	fd	5	abs.d	Double-precision absolute value of fs is placed into fd.
17	17	0	fs	fd	6	mov.d	Double precision move of value in fs into fd.
<b>Data Movement Operations</b>							
49	rs	fd	offset			lwc1	Load word to FPA
57	rs	fd	offset			swc1	Store word from FPA



Integrated Device Technology, Inc.

### **CP0 Operation Details**

This section documents the operations for the on-chip CP0 in R30xx family processors. It contains a detailed description for each instruction in alphabetic order.

### **MMU Operations**

Most of the CP0 operations are designed to manage the on-chip TLB of “E” versions of the family. Instructions are provided to read, write, and probe the TLB.

### **Exception Operations**

A single instruction is provided to support exception operation: the **rfe** instruction restores the proper Interrupt Enable and Kernel/User mode bits of the status register on return from exception.

### **Dand Register Movement Operations**

The standard **mtc0**, **ctc0**, **mfc0**, and **cfc0** operations were described in Appendix A.

### **Operation Descriptions**

The CP0 instructions are described in detail in alphabetic order. Each page contains the following information for the instruction:

- Instruction mnemonic and name
- Assembler format
- Description of the instruction
- Operation of the instruction described in pseudocode.
- Exceptions that the instruction can cause

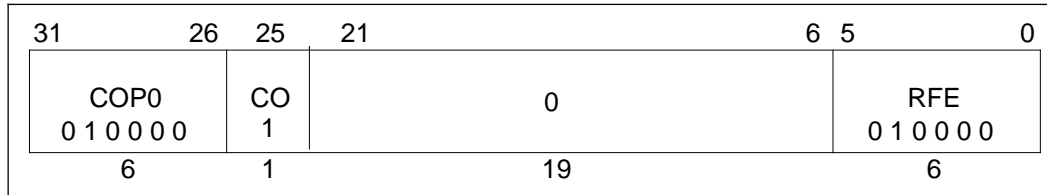
**RFE****Restore from  
Exception****RFE****Format:**

RFE

**Description:**

RFE restores the “previous” interrupt enable mask bit and kernel/user mode bit (IEp and KUp) of the Status Register into the corresponding “current” status bits (IEc and KUc), and restores the “old” Status bits (IEo and KUo) into the corresponding “previous” status bits (IEp and KUp). The “old” status bits remain unchanged.

The MIPS architecture does not specify the operation of memory references associated with load/store instructions immediately prior to an RFE instruction. Normally, the RFE instruction follows in the delay slot of a JR instruction to restore the PC.

**Operation:**

T: $SR \leftarrow SR_{31..4}    SR_{5..2}$
--

**Exceptions:**

Coprocesor unusable exception

**TLBP                      TLB Probe                      TLBP**

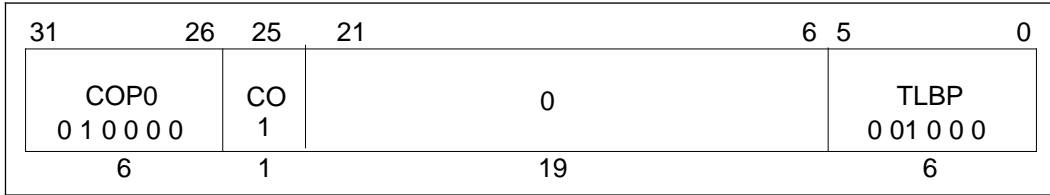

**Format:**

TLBP

**Description:**

The Index register is loaded with the address of the TLB entry whose contents match the contents of the EntryHi register. If no TLB entry matches, the high-order bit of the Index register is set.

The architecture does not specify the operation of memory references associated with instructions immediately after a TLBP instruction, nor is the operation specified if more than one TLB entry matches.

This instruction is only valid for “E” versions of the R30xx family. Its result for members without an on-chip TLB is undefined.

**Operation:**

```

T:   Index ← 1 || 031
for i in 0..63
    if (TLB[i]63..44 = EntryHii31..12) and {TLB[i]8 or (TLB[i]43..38 = EntryHii11..6)} then
        Index ← 018 || i5..0 || 08
    endif
endfor
    
```

**Exceptions:**

Coprocessor unusable exception

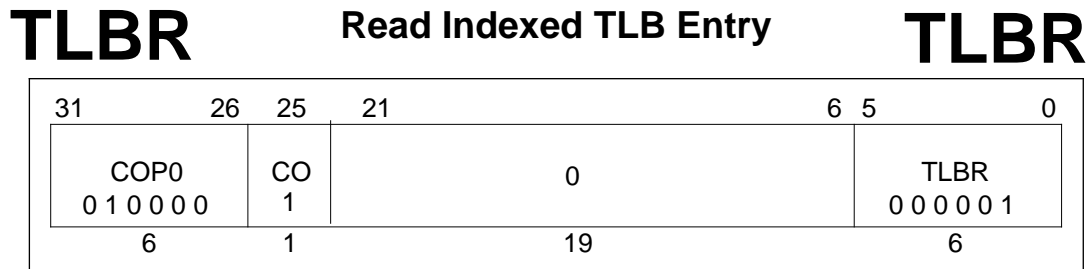
**Format:**

TLBR

**Description:**

The EntryHi and EntryLo registers are loaded with the contents of the TLB entry pointed at by the contents of the TLB Index register.

This operation is only valid for “E” version members of the R30xx family. Its result for members without an on-chip TLB is undefined.

**Operation:**

T:	EntryHi $\leftarrow$ TLB[Index <sub>13..8</sub> ] <sub>63..32</sub>
	EntryLo $\leftarrow$ TLB[Index <sub>13..8</sub> ] <sub>31..0</sub>

**Exceptions:**

Coprocessor unusable exception

# TLBWI      Write Indexed TLB Entry      TLBWI

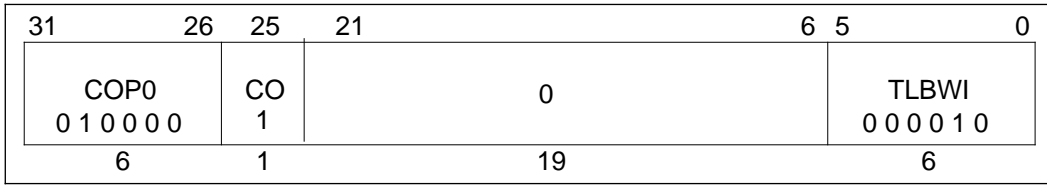

**Format:**

TLBWI

**Description:**

The TLB entry pointed at by the contents of the Index register is loaded with the contents of the EntryHi and EntryLo registers.

This operation is only valid for “E” version members of the R30xx family. Its result for members without an on-chip TLB is undefined.

**Operation:**

T:	TLB[Index <sub>13..8</sub> ] ← EntryHi  EntryLo
----	---

**Exceptions:**

Coprocessor unusable exception



# TLBWR Write Random TLB Entry TLBWR

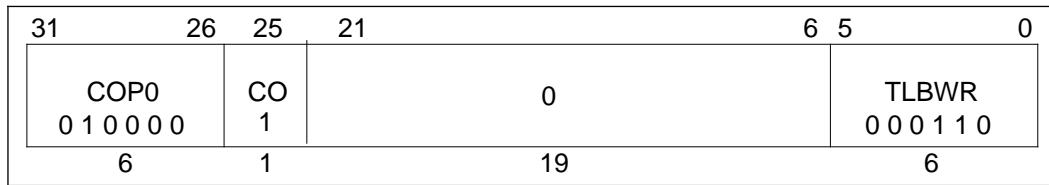

## Format:

TLBWR

## Description:

The TLB entry pointed at by the contents of the Random register is loaded with the contents of the EntryHi and EntryLo registers.

This operation is only valid for “E” version members of the R30xx family. Its result for members without an on-chip TLB is undefined.

## Operation:

T:	TLB[Random <sub>13..8</sub> ] ← EntryHi  EntryLo
----	--

## Exceptions:

Coprocessor unusable exception

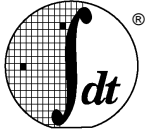

Integrated Device Technology, Inc.

## ASSEMBLER LANGUAGE SYNTAX

## APPENDIX D

This appendix describes the assembler syntax valid for most R30xx assemblers..

The *compiler-dir* directives in the syntax are for use by compilers only, and they are not described in this book.

*statement-list:*

*statement*  
*statement statement-list*

*statement:*

*stat \n*  
*stat ;*

*stat:*

*label*  
*label instruction*  
*label data*  
*instruction*  
*data*  
*symdef*  
*directive*

*label:*

*identifier :*  
*decimal :*

*identifier:*

[A-Za-z.\$\_][A-Za-z0-9.\$\_]

*instruction:*

*opcode*  
*opcode operand*  
*opcode operand , operand*  
*opcode operand , operand , operand*

*opcode:*

**add**  
**sub**  
etc.

*operand:*

*register*  
*( register )*  
*addr-immed ( register )*  
*addr-immed*  
*float-register*  
*float-const*

*register:*

*decimal*

*float-register:*

*decimal*

*addr-immed:*

*label-expr*  
*label-expr + expr*  
*label-expr - expr*  
*expr*

*label-expr:*

*label-ref*  
*label-ref - label-ref*

*label-ref:*

*numeric-ref*  
*identifier*  
*.*

*numeric-ref:*

*decimalf*  
*decimalb*

*data:*

*data-mode data-list*  
**.ascii** string  
**.asciiz** string  
**.space** expr

*data-mode:*

**.byte**  
**.half**  
**.hword**  
**.word**  
**.int**  
**.long**  
**.short**  
**.float**  
**.single**  
**.double**  
**.quad**  
**.octa**

*data-list:*

*data-expr*  
*data-list , data-expr*

*data-expr:*

*expr*  
*float-const*  
*expr : repeat*  
*float-const : repeat*

*repeat:*

*expr*

*symdef:*

*constant-id = expr*

*constant-id:*

*identifier*

*directive:*

*set-dir*  
*segment-dir*

---

*align-dir*  
*symbol-dir*  
*block-dir*  
*compiler-dir*

*set-dir:*

**.set** [no]volatile  
**.set** [no]reorder  
**.set** [no]at  
**.set** [no]macro  
**.set** [no]bopt  
**.set** [no]move

*segment-dir:*

**.text**  
**.data**  
**.rdata**  
**.sdata**

*align-dir:*

**.align** *expr*

*symbol-dir:*

**.globl** *identifier*  
**.extern** *identifier* , *constant*  
**.comm** *identifier* , *constant*  
**.lcomm** *identifier* , *constant*

*block-dir:*

**.ent** *identifier*  
**.ent** *identifier* , *constant*  
**.aent** *identifier* , *constant*  
**.mask** *expr* , *expr*  
**.fmask** *expr* , *expr*  
**.frame** *register* , *expr* , *register*  
**.end** *identifier*  
**.end**

*compiler-dir:*

**.alias** *register* , *register*  
**.bgnb** *expr*  
**.endb** *expr*  
**.file** *constant string*  
**.galive**  
**.gjaldef**  
**.grlive**  
**.lab** *identifier*  
**.livereg** *expr* , *expr*  
**.noalias** *register* , *register*  
**.option** **flag**  
**.verstamp** *constant constant*  
**.vreg** *expr* , *expr*

*expr:*

*expr* *binary-op* *expr*  
*term*

*term:*

*unary-operator* *term*  
*primary*

*primary:*

*constant*  
 ( *expr* )

*binary-op*: one of  
 \*     /     %  
 +     -  
 <<    >>  
 &  
 ^  
 |

*unary-operator*: one of  
 +     -     ~     !

*constant*:  
 decimal  
 hexadecimal  
 octal  
 character-const  
 constant-id

*decimal*:  
 [1-9][0-9]+

*hexadecimal*:  
 0x[0-9a-fA-F]+  
 0X[0-9a-fA-F]+

*octal*:  
 0[0-7]+

*character-const*:  
 'x'

*string*:  
 "xxxx"

*float-const*: for example  
 1.23   .23   0.23   1.     1.0   1.2e10 1.2e-15

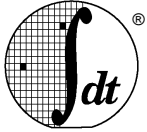

Integrated Device Technology, Inc.

This appendix describes two object file formats that are often used in MIPS development systems. Object files are created by the compiler and/or assembler, and the link editor. An object file is a binary representation of part or all of a program, and usually has two distinct forms:

- *Relocatable object file*: holds the code and data resulting from the compilation of a single module, suitable for linking with other relocatable object files to create an executable object file. A relocatable file includes relocation information and symbol tables which allow the link editor to combine the individual modules, and to patch (relocate) instructions or data which depend on the program's final location in memory. Other parts of the file may encode information to support symbolic debugging.
- *Executable object file*: holds a complete program, suitable for direct execution by a CPU. This file will not include relocation information, but may add a simple header which tells the operating system or bootstrap loader where each part of the object file is to be located in memory.

The software development system should be equipped with tools to allow the programmer to inspect the contents of an object file, or to convert it into alternative (possibly ASCII) formats which can be downloaded to a PROM programmer or evaluation board. Common tools are described below.

### SECTIONS AND SEGMENTS

An object file consists of a number of separate *sections*: most correspond to the program's instructions and data, but some additional sections hold information for linkers and debuggers. Each section has a name to identify it (e.g. ".text" and ".rdata"), and a complete list of the standard program sections recognized by the development toolchain should be included in its documentation.

The reason for splitting the program up like this is so that the link editor can then merge the different parts of the program that need to be located together in memory (e.g. a ROMable program needs all code and read-only data in ROM, but writable data in RAM). When the link editor produces the final executable object file it concatenates all *sections* of the same name together, and then further merges those sections which are located together in memory into a smaller number of contiguous *segments*. An object file header is prepended to identify the position of each segment in the file, and its intended location in memory.

### ECOFF OBJECT FILE FORMAT (RISC/OS)

The original MIPS Corp. compilers were Unix-based and until fairly recently used the ECOFF object code format. Development systems from other vendors often use or at least support inter-linking with this format, in the interests of compatibility. ECOFF is based on an earlier format called COFF, which stands for *Common Object File Format*, and first appeared in early versions of Unix System V. COFF was a brave (and largely unsuccessful) attempt to define a flexible object code format that would be portable to a large number of processor architectures.

The "E" in "ECOFF" stands for *Extended*. The MIPS engineers wanted the flexibility of COFF to support gp-relative addressing, which would have been impossible with the restrictive format used on earlier Unix systems. However they decided to replace the COFF symbol table and debug data

with a completely different design. The ECOFF symbol table format is certainly much more powerful and compact than the rather primitive COFF format, but it is also much more difficult to generate and interpret.

Fortunately, embedded system applications are unlikely to be concerned with the internal structure of the symbol tables. The programmer probably only needs to recognize the COFF *file header* and “optional” *a.out* header, which are largely unchanged from the original COFF definitions.

## File header

The COFF file header consists of the following 20 bytes at the start of the file:

Offset	Type	Name	Purpose
0	unsigned short	f_magic	Magic number (see below)
2	unsigned short	f_nscns	Number of sections
4	long	f_timdat	Time and date stamp (Unix style)
8	long	f_symptr	File offset of symbol table
12	long	f_nsyms	Number of symbols
16	unsigned short	f_opthdr	Size of optional header
18	unsigned short	f_flags	Various flag bits

From this list only the following fields are really important:

- *f\_magic*: must be one of the following values: Object files with the

Name	Value	Meaning
MIPSEBMAGIC	0x0160	Big-endian MIPS binary
MIPSELMAGIC	0x0162	Little-endian MIPS binary
SMIPSEBMAGIC	0x6001	Big-endian MIPS binary with little-endian headers
SMIPSELMAGIC	0x6201	Little-endian MIPS binary with big-endian headers

SMIPS... magic numbers were generated on hosts of the opposite endianness, and software will have to individually byte-swap each field required from the file and *a.out* headers.

- *f\_opthdr*: the size in the file of the *a.out* header: this value is used to work out the program’s offset in the file.
- *f\_nscns*: the number of *section* headers in the file: this is also needed to work out the program’s offset.

## Optional a.out header

The *a.out* header is a left-over from earlier Unix versions, which has been shoe-horned into COFF. It follows the COFF file header, and does the job of coalescing the COFF *sections* into exactly three contiguous *segments*: text (instructions and read-only data); data (initialized, writable data); and BSS (uninitialized data, set to zero).

Offset	Type	Name	Purpose
0	short	magic	Magic number
2	short	vstamp	Version stamp

4	long	tsize	Text size
8	long	dsize	Data size
12	long	bsize	BSS size
16	long	entry	Entry-point address
20	long	text_start	Text base address
24	long	data_start	Data base address
28	long	bss_start‡	BSS base address
32	long	gprmask‡	General registers “used” mask
36	long	cprmask[4]‡	Coprocessor registers used masks
52	long	gpvalue‡	GP value for this file

Those fields marked ‡ are new to ECOFF, and not found in the original COFF definition.

The magic number in this structure does not specify the type of CPU, but describes the layout of the object file, as follows: The following macro

Name	Value	Meaning
OMAGIC	0x0107	Text segment is writable
NMAGIC	0x0108	Text segment is read-only
ZMAGIC	0x010b	File is demand-pageable (not for embedded use)

shows how to calculate the file offset of the text segment. In words, and ignoring ZMAGIC files, it is found after the COFF file header, *a.out* header and COFF section headers, rounded up to the next 8 or 16 byte boundary (depending on the compiler version).

```
#define FILHSZ sizeof(struct filehdr)
#define SCNHSZ /*sizeof(struct scnhdr)*/ 40

#define N_TXTOFF(f, o) \
((a).magic == ZMAGIC ? 0 : ((a).vstamp < 23 ? \
((FILHSZ + (f).opthdr + (f).f_nscns * SCNHSZ + 7) & ~7) : \
((FILHSZ + (f).opthdr + (f).f_nscns * SCNHSZ + 15) & ~15) ))
```

### Example loader

The following code fragment draws together the above information to implement a very simple-minded ECOFF file loader, as might be found in a bootstrap PROM which can read files from disk or network. It returns the entry-point address of the program, or zero on failure.

```
unsigned long load_ecoff (int fd)
{
    struct filhdr fh;
    struct aouthdr ah;

    /* read file header and check */
    read (fd, &fh, sizeof (fh));
#ifdef MIPSEB
    if (fh.f_magic != MIPSEBMAGIC)
#else
    if (fh.f_magic != MIPSELMAGIC)
#endif
    return 0;
}
```



```

/* read a.out header and check */
read (fd, &ah, sizeof (ah));
if (ah.magic != OMAGIC && ah.magic != NMAGIC)
return 0;

/* read text and data segments, and clear bss */
lseek (fd, N_TXTOFF (fh, ah), SEEK_SET);
read (fd, ah.text_start, ah.tsize);
read (fd, ah.data_start, ah.dsize);
memset (ah.bss_start, 0, ah.bsize);

return ah.entry;
}

```

## Further reading

For more detailed information on the original COFF format, consult a *Unix System V.3 Programmer's Guide*. The ECOFF symbol table extensions are not documented, but the header files which define it (which are copyright of MIPS Corporation, now MTI) have now been made available for re-use and redistribution. You'll find copies with the rights documented in recent versions of GNU binary utilities.

## ELF (MIPS ABI)

ELF, which stands for *Executable and Linking Format*, is an attempt to improve on COFF and define an object file format which supports a range of different processors, while allowing vendor-specific extensions that do not break compatibility with other tools. It first appeared in Unix System V Release 4, and is used by recent versions of MIPS Corp compilers, and some other development systems.

As in the examination of COFF, this manual will look only at the minimum amount of the structure which is necessary to load an executable file into memory.

## File header

The ELF file header consists of 52 bytes at the start of the file, and provides the means to determine the location of all the other parts of the file. The following fields are relevant when loading an ELF file:

Offset	Type	Name	Purpose
0	unsigned char	e_ident[16]	File format identification
16	unsigned short	e_type	Type of object file
18	unsigned short	e_machine	CPU type
20	unsigned long	e_version	File format
24	unsigned long	e_entry	Entry point address
28	unsigned long	e_phoff	Program header file offset
32	unsigned long	e_shoff	Section header file offset
36	unsigned long	e_flags	CPU-specific flags
40	unsigned short	e_ehsize	File header size
42	unsigned short	e_phentsize	Program header entry size
44	unsigned short	e_phnum	Number of program header entries
46	unsigned short	e_shentsize	Section header entry size

48	unsigned short	e_shnum	Number of section header entries
50	unsigned short	e_shstrndx	Section header string table index

- *e\_ident*: contains machine-independent data to identify this as an ELF file, and describe its layout. The individual bytes within it are as follows:

Offset	Name	Expected Value	Purpose
0	EI_MAG0	ELFMAG0=0x7f	Magic number identifying an ELF file
1	EI_MAG1	ELFMAG1='E'	
2	EI_MAG1	ELFMAG2='L'	
3	EI_MAG3	ELFMAG3='F'	
4	EI_CLASS	ELFCLASS32=1	Identifies file's word size.
5	EI_DATA	ELFDATA2LSB=1	Indicates little-endian headers and program
		ELFDATA2MSB=2	Indicates big-endian headers and program
6	EI_VERSION	EV_CURRENT=1	Gives file format version number

- *e\_machine*: Specifies the CPU type for which this file is intended, selected from the values in the table below.

Obviously for this discussion the value should be EM\_MIPS.

Name	Value	Meaning
EM_M32	1	AT&T WE32100
EM_SPARC	2	SPARC
EM_386	3	Intel 80386
EM_68K	4	Motorola 68000
EM_88K	5	Motorola 88000
EM_860	7	Intel 80860
EM_MIPS	8	MIPS R3000

- *e\_entry*: The entry point address of the program.
- *e\_phoff*: The file offset of the program header, which will be required to load the program.
- *e\_phentsize*: The size (in bytes) of each program header entry.
- *e\_phnum*: The number of entries in the program header.

### Program Header

Having verified the ELF file header, software will require the program header. This part of the file contains a variable number of entries, each of which specify a *segment* to be loaded into memory. Each entry is at least 32 bytes long and has the following layout:

Offset	Type	Name	Purpose
0	unsigned long	p_type	Type of entry

4	unsigned long	p_offset	File offset of segment
8	unsigned long	p_vaddr	Virtual address of segment
12	unsigned long	p_paddr	Physical address of segment (unused)
16	unsigned long	p_filesz	Size of segment in file
20	unsigned long	p_memsz	Size of segment in memory
24	unsigned long	p_flags	Segment attribute flags
28	unsigned long	p_align	Segment alignment (power of 2)

The relevant fields are as follows:

- *p\_type*: Only entries marked with a type of PT\_LOAD (1) should be loaded; others can be safely ignored.
- *p\_offset*: The absolute offset in the file of the start of this segment.
- *p\_vaddr*: The virtual address in memory at which the segment should be loaded.
- *p\_filesz*: The size of the segment in the file; this may be zero.
- *p\_memsz*: The size of the segment in memory. If this is greater than *p\_filesz*, then the extra bytes should be cleared to zero.
- *p\_flags*: A bitmap giving read, write and execute permissions for the segment. This is largely irrelevant for embedded systems, but does allow the code segment to be identified.

Name	Value	Meaning
PF_X	0x1	Execute
PF_W	0x2	Write
PF_R	0x4	Read

## Example loader

The following code fragment draws together the above information to implement a very simple-minded ELF file loader, as might be found in a bootstrap PROM which can read files from disk or network. It returns the entry-point address of the program, or zero on failure.

```

unsigned long load_elf (int fd)
{
    Elf32_Ehdr eh;
    Elf32_Phdr ph[16];
    int i;

    /* read file header and check */
    read (fd, &eh, sizeof (eh));

    /* check header validity */
    if (eh.e_ident[EI_MAG0] != ELF_MAG0 ||
        eh.e_ident[EI_MAG1] != ELF_MAG1 ||
        eh.e_ident[EI_MAG2] != ELF_MAG2 ||
        eh.e_ident[EI_MAG3] != ELF_MAG3 ||
        eh.e_ident[EI_CLASS] != ELFCLASS32 ||
#ifdef MIPSEB
        eh.e_ident[EI_DATA] != ELFDATA2MSB ||
#else
        eh.e_ident[EI_DATA] != ELFDATA2LSB ||
#endif
        eh.e_ident[EI_VERSION] != EV_CURRENT ||
        eh.e_machine != EM_MIPS)
        return 0;
}

```

```

/* is there a program header of the right size */
if (eh.e_phoff == 0 || eh.e_phnum == 0 || eh.e_phnum > 16 ||
    eh.e_phentsize != sizeof(Elf32_Phdr))
    return 0;

/* read program header */
lseek (fd, eh.e_phoff, SEEK_SET);
read (fd, ph, eh.e_phnum * eh.e_phentsize);

/* load each program segments */
for (i = 0; i < eh.e_phnum; i++) {
    if (ph[i].p_type == PT_LOAD) {
        if (ph->p_filesz) {
            lseek (fd, ph[i].p_offset, SEEK_SET);
            read (fd, ph[i].p_vaddr, ph[i].p_filesz);
        }
        if (ph[i].p_filesz < ph[i].p_memsz)
            memset (ph[i].p_vaddr + ph[i].p_filesz, 0,
                ph[i].p_memsz - ph[i].p_filesz);
        }
    }

    return eh.eh_entry;
}

```

### Further Reading

The ELF format, including MIPS-specific extensions, is extensively documented in *Unix System V.4 MIPS Processor-Specific ABI* book.

### OBJECT CODE TOOLS

A particular software development system will be equipped with a number of tools for examining and manipulating object files. The following list assumes Unix-type names, but systems with a different ancestry will probably offer similar tools, even if the names are different:

Program Name	Function
ar	This tool allows you to list, add and remove object files from a library. The name comes from <i>archive</i> , the historical Unix name for the file type used to store libraries and later specialized for this purpose.
convert (objcopy)	Converts executable object file from binary to some other format which can be downloaded to a PROM programmer or evaluation board.
ld	The link/loader, used to glue object codes together and also to assign fixed target-system addresses to sections (in some systems this would involve two separate programs typically called <i>link</i> and <i>locate</i> ).
nm	Lists the names in an object file's symbol table in alphabetic or numeric order.
objdump/odump	Displays the program data of the object file in various useful forms; in particular, can usually disassemble the code sections.
ranlib	if present, builds a global "table of contents" in a library which makes it much faster for <i>ld</i> to read. On modern systems <i>ar</i> usually has an option to do this job, and <i>ranlib</i> may well just be an alias for that option.
size	Displays the size of each <i>section</i> in the object file.

strip	Removes everything from the object file which is not necessary to load the program, making it (much) smaller; gets rid of symbol tables and debug information. Some people do this to make it harder to disassemble the program.
-------	--

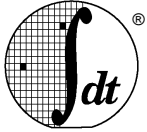

Integrated Device Technology, Inc.

## GLOSSARY OF COMMON "MIPS" TERMS

## APPENDIX F

*Sfnn register*: one of the 32 general-purpose 32-bit floating point registers. Only even-numbered ones can be used for arithmetic (the odd-numbered registers hold the low-order bits of 64-bit, double-precision, numbers).

*Snn register*: one of the CPU's 32 general-purpose registers.

*a0-a3 register*: aliases for CPU registers \$4-\$7, conventionally used for passing the first four words of the arguments to a function.

*address regions*: refers to the division of the MIPS program address space into regions called kuseg, kseg0, kseg1 and kseg2.

*alignment*: positioning of data in a memory with respect to size boundaries (keeping words aligned on modulo-4 addresses, and half-words aligned on modulo-2 addresses).

*alloca*: C library function returning a memory area which will be implicitly freed on return from the function where the call is made from.

*ALU*: arithmetic/logic unit - a term applied to the part of the CPU which does computational functions

*analyzer*: see logic analyzer.

*Apache group (SVR4.2)*: an industry group of suppliers of MIPS-architecture "Unix" systems who are co-operating on a standard version of Univel's System V Release 4.2 operating system.

*architecture*: see ISA.

*argument*: a value passed to a function, in "C" terminology - often called a parameter in other languages. "C" arguments are "parameters passed by value" - if that helps.

*ASCII*: used very loosely for the character encoding used by the C language.

*ASID*: the address space ID maintained in the CPU register "EntryHi". Used to select a particular set of address translations - only those translations whose own ASID field matches the current value will produce valid physical addresses.

*associative store*: a memory which can be looked up by presenting part of the stored data. It requires a separate comparator for each data field, so large associative stores use up prodigious amounts of logic. The R30xx family TLB ("E" versions) is a fully-associative 64-entry store.

*BadVaddr register*: CPU control register which holds the value of an address which just caused a trap for some reason (misaligned, inaccessible, TLB miss etc.).

*bcopy*: C library function to copy the contents of a chunk of memory.

*BEV*: "boot exception vectors": a bit in the CPU status register which causes traps to go through a pair of alternate vectors located in uncached (kseg1) memory. The locations are close to the reset-time start point, so that they can both conveniently be mapped to the same read-only memory.

*big-endian*: describes an architecture where the most-significant part of a multi-byte integer is stored at the lowest byte address.

*bitfield*: a part of a word which is interpreted as a collection of individual bits.

*branch and link*: a PC-relative subroutine call.

*branch delay slot*: the position in the instruction sequence immediately following a jump/branch instruction. The instruction in the branch delay slot is always executed, before the instruction which is the target of the branch. It is sometimes necessary to fill the branch delay slot with a “nop” instruction.

*branch optimization*: the process (carried out by the compiler, assembler or programmer) of adjusting the sequence of instructions so as to make the best use of branch delay slots.

*branch*: in the MIPS instruction set, a PC-relative jump.

*BrCond3-0*: CPU inputs which are directly tested by the “coprocessor conditional branch” instructions.

*breakpoint*: when debugging a program, a breakpoint is an instruction position where the debugger will take a trap and return control to the user. Implemented by pasting a “break” instruction into the instruction sequence under test.

*bss*: in a compiled C program, that chunk of memory which holds variables declared but not explicitly initialized. Corresponds to a “segment” of object code.

*burst read cycles*: R30xx family CPUs often refill their caches by fetching 4 words at a time from memory in a burst read cycle.

*busctrl register*: CPU register, implemented on the R3041 CPU only, which allows the programmer to set up some options for how bus accesses are carried out.

*byte gathering, write merging*: when writes are stored in a *write buffer* it may happen that two writes to the same word (often to different bytes in the same word) may happen before the address and data are sent to memory. R30xx family CPUs don't do this, to avoid problems when writing to IO subsystems.

*byte order*: used to emphasize the ordering of items in memory by byte address.

*byteswap*: the action of reversing the order of the constituent bytes within a word. This may be required when adapting data acquired from a machine of non-matching “endianness”.

*cache - direct mapped*: a direct mapped cache has, for any particular line in memory, only one slot where it can cache the contents of that line. Direct-mapped caches are simple, so they can run fast.

R30xx family onchip caches are direct-mapped.

*cache - physical addressed*: a cache which is accessed entirely by using physical (translated) addresses. All R30xx family on-chip caches are physical.

*cache - snooping*: in a cache, snooping is the action of monitoring the bus activity of some other device (another CPU or DMA master) to look for references to data which are held in the cache. Originally, “snooping” was used for caches which can *intervene*, offering their own version of the data where it is more up to date than the memory data which will otherwise be obtained by the other master; but the word has come to be used for any cache which monitors bus traffic.

*cache coherency*: the process of insuring that the CPU caches match, precisely, the contents of the memory which lie behind them.

*cache flush*: In the R30xx family, this term is used as a synonym for “invalidate”.

*cache invalidation*: marks a line of cache data as no longer to be used. There's always some kind of “valid” bit in the control bits of the cache line for this purpose.

- cache lines*: A cache line refers to the number of datum elements which share a single tag field. In the R30xx family, the instruction-cache uses a 4-word (16-byte) line size, and the data cache uses a 1 word (4 byte) line size.
- cache miss*: A reference into the cache for memory not currently contained in the cache.
- cache profiling*: measuring the cache traffic generated when a particular program runs, with a view to re-arranging the program in memory to minimize the number of cache misses, or to selecting the appropriate R30xx family member (or configuration of the R3071 or R3081) for a particular system.
- cache refill*: the memory read which is used to obtain a cache line of data after a cache miss. This is first read into the cache, and the CPU then restarts execution – this time “hitting” in the cache.
- cache simulator*: a software tool used for cache profiling.
- cache tag*: the information held with the cache line which identifies the main memory location of the data.
- cacheable*: applied to an address region or a page defined by the memory translation system, this means that the contents of the memory region may be resident in the on-chip caches.
- callee*: in a function call, the “callee” is the function which is called.
- Cause register*: CPU control register which, following a trap, indicates the kind of trap. *Cause* also shows which external interrupt signals are active.
- CohReq\* (R3081 only)*: an external signal fed into an R3081 CPU which will cause a D-cache entry to be automatically invalidated by a write to the appropriate memory location performed by an external bus master.  
Note that even where the addressed location is not present in the R3081 D-cache, this still causes the CPU to be stopped for a few cycles while the D-cache tags are invalidated.
- Compare register*: CPU control register provided on CPUs implementing a timer (just the R3041 at the time of writing).
- Config register*: CPU control register for configuring basic CPU behavior, provided only on R3041, R3071, and R3081.
- const*: “C” data declaration attribute, implying that the data is read-only. It will often then be packed together with the instructions.
- Context register*: CPU control register only seen on CPU types with a TLB (“-E” variants). Provides a fast way to process page faults on systems using a certain arrangement of page tables.
- context switch*: the job of changing the software environment from one “task” to another in a multitasking OS.
- coprocessor conditional branches*: the instructions **bc0t label** etc. branch according to the sense of “coprocessor conditions” which are usually CPU input signals; can be useful for input pin polling, fast exception decode, etc. If there is a floating point unit onchip, “coprocessor condition bit 1” is hard-wired to the FP condition code.
- coprocessor zero*: the bits of CPU function which are connected with the privileged control instructions for memory mapping, exception handling, and such like.
- coprocessor*: some part of the CPU, or some closely-coupled other thing, which executes some particular set of reserved instruction encodings.
- Count register*: running timer register (R3041).
- CPCOND*: see BrCond(3:0).
- D-cache*: data cache (R30xx CPUs always have separate instruction and data caches).



*data dependencies*: the relationship between an instruction which produces a value in a register, and a subsequent instruction which wants to use that value.

*data path swapper*: see byte swapper.

*data/instruction cache coherency*: the job of keeping the I-cache and D-cache coherent. This can become an issue in a number of circumstances: it is vital to invalidate I-cache locations whenever writing or modifying an instruction stream; D-Cache coherency may be an issue in systems where an external DMA master updates some portion of cacheable memory. See coherency.

*DECstation*: Digital Equipment Corporation's trade name for DEC's MIPS-architecture workstations.

*delayed branches*: see branch delay slot.

*delayed loads*: see load delay slot.

*denormalized*: a floating point number is "denormalized" when it is holding a value too small to be represented with the usual precision. The way the IEEE765 standard is defined makes it quite hard for hardware to cope directly with denormalized representations, so The R3081 FPA always traps when presented with them or asked to compute them.

*direct mapped*: see cache (direct mapped).

*dirty*: in a virtual memory system, describes the state of a page of memory which has been written to since it was last fetched from or written back to secondary storage. "Dirty" pages must not be lost.

*dis-assembler*: a program which takes a binary instruction sequence in memory and produces a listing in assembler mnemonics.

*DMA*: "direct memory access", an external device transferring data to or from memory without CPU intervention.

*double*: "C" and assembler-language name for a double-precision (64-bit) format floating point number.

*download*: the act of transferring data from "host" to "target" (typically, the host is the computer which runs the compiler and/or debugger, and the target is the system with the R30xx CPU).

*DRAM*: used to refer to large memory systems (which are usually built from DRAM components). Sometimes used to discuss the typical attributes of memories built from DRAMs.

*ECOFF*: an object code format, particularly used by MIPS Corporation and Silicon Graphics, extensively evolved from Unix Systems Laboratories' "COFF" format.

*ELF*: an object code format defined by Univel for Unix SVR4.2, and which is mandated by the MIPS/ABI standard.

*embedded*: describes a processing system, which may be part of a larger object, which is not (primarily) seen as a computer. Specifically, embedded systems usually have their "programs" determined when the machine is built.

*emulator*: see in-circuit emulator, software instruction emulator.

*endianness*: whether a machine is big-endian or little-endian. See the chapter on "Portability" for details.

*endif*: see *ifdef*.

*EntryHi/EntryLo register*: CPU control registers implemented only in CPUs with a TLB. Used to stage data to and from TLB entries.

*epc register*: "exception program counter": CPU control register telling where to restart the CPU after an exception.

*EPROM*: "erasable programmable read-only memory": the device most commonly used to provide read-only code for system bootstrap, and used in this manual to mean the location of that read-only code.

- ExcCode*: the bitfield in the *Cause* register which contains a code showing what type of exception just occurred.
- exception*: in the MIPS architecture, an exception is any interrupt or trap which causes control to be diverted to one of the trap entry points.
- Executable*: describes a file of object code which is ready to run.
- exponent*: part of a floating point number, described in the chapter on floating point.
- Extended floating point*: not provided by the MIPS hardware, this usually refers to a floating point format using 80 bits of storage.
- extern*: "C" data attribute for a variable which is defined in another module.
- FCR31 register*: this is the floating point control/status register, described in the floating point chapter.
- fixup*: in object code, this is the action of a linker/locator program when it adjusts addresses in the instruction or data segments to match the location at which the program will eventually execute. This term is also used to describe a particular CPU clock cycle in which the conditions which caused the processor to stall are "fixed-up" to allow the CPU to resume execution.
- float*: A name for a single precision floating point number.
- Floating point accelerator (FPA)*: the name for the part of the MIPS CPU which does floating point math. Historically, it was a separate chip.
- floating point bias*: an offset added to the exponent of a floating point number held in IEEE format, to make sure that the exponent is positive for all legitimate values.
- floating point condition code/flag*: a single bit set by FP compare instructions, which is communicated back to the main part of the CPU and tested by **bc1t** and **bc1f** instructions.
- floating point emulation trap*: a trap taken by the CPU when it cannot implement a floating point (coprocessor 1) operation. A software trap handler can be built which mimics the action of the FPU and returns control, so that application software need not know whether FPA hardware is installed or not. The software routine is likely to be 50-300 times slower than hardware, and 10 or more times slower than a "soft-float" approach.
- fp register (frame pointer)*: a CPU general purpose register (\$30) sometimes used conventionally to mark the base address of a stack frame.
- fpcond*: another name for the FP condition bit (also known as coprocessor 1 condition bit etc.).
- fraction*: part of a floating point value, described in the FPA chapter.
- Free Software Foundation*: the (loose) organization behind GNU software.
- fully-associative*: see associative store.
- function epilogue*: in assembler code, the stereotyped sequence of instructions and directives found at the end of a function, and concerned with returning to the caller.
- function inlining*: an optimization offered by advanced compilers, where a function call is replaced by an interpolated copy of the complete instruction sequence of the called function. In many architectures this is a big win (for very small functions) because it eliminates the function-call overhead. In the MIPS architecture the function-call overhead is negligible, but inlining is still sometimes valuable because it allows the optimizer to work on the function in context.
- function prologue*: in assembler language, a stereotyped set of instructions and directives which start a function, saving registers and setting up the stack frame.
- global pointer*: see gp register.

- globl*: assembler declaration attribute, for data items or code entry points which are to be visible from outside the module.
- GNU C compiler*: the freely-redistributable compiler developed by the Free Software Foundation. An excellent MIPS code generator is available.
- GOT*: the “global offset table”, an essential part of the dynamic linking mechanism underlying MIPS/ABI applications.
- gp register*: CPU register \$28, often used as a pointer to program data. Program data which can be linked within +-32K of the pointer value can be loaded with a single instruction. Not all toolchains, nor all runtime environments, support this.
- halfword*: a 16-bit data type.
- hazard*: see pipeline hazard.
- heap*: program data space allocated at run-time.
- I-cache*: the instruction cache of a MIPS CPU.
- IDT*: Integrated Device Technology Corporation.
- IEEE754 floating point standard*: an industry standard for the representation of arithmetic values. It mandates the precise behavior of a group of basic functions. This provides a stable base for the development of portable numeric algorithms.
- ifdef*: “#ifdef” and “#endif” bracket conditionally-compiled code in the C language.
- immediate*: in the instruction set descriptions, an “immediate” value is a constant which is embedded in the code sequence. In assembler language, it is any constant value.
- in-circuit emulator (ICE)*: a device which replaces a CPU chip with a module which, as well as being able to exactly imitate the behavior of the CPU, provides some means to control execution and examine CPU internals. Microprocessor ICE units are inevitably based on a version of the microprocessor chip (often a higher speed grade).
- Index register*: CPU control register used to define which TLB entry’s contents will be read into or written from *EntryHi/EntryLo*.
- inexact*: describes a floating point calculation which has lost precision. Note that this happens very frequently on the most everyday calculations – the number 1/3 has no exact representation. IEEE754 compliance requires that MIPS CPUs can trap on an inexact result, although that trap is rarely enabled.
- infinity*: a floating point data value standing in for any value too big (or too negative) to represent. IEEE754 defines how computations with positive and negative versions of “infinity” should behave.
- instruction scheduling*: the process of moving instructions around to make the best use of “delay slots”, performed by the compiler and (sometimes) by the assembler.
- instruction set architecture (ISA)*: the functional description of the CPU, which defines exactly what it does with any legitimate instruction stream (but does not have to define how it is implemented).
- instruction synthesis by assembler*: the MIPS instruction set omits many useful and familiar operations (such as an instruction to load a constant outside the range +-32K). Most assemblers for the MIPS architecture will accept instructions (sometimes called *macro instructions* or *synthetic instructions*) which they implement with a short sequence of machine instructions.
- interlock*: a hardware feature where the execution of one instruction is delayed until something is ready.
- interrupt mask*: a bit-per-interrupt mask, held in the CPU *Status* register, which determines which interrupt inputs are allowed to cause an interrupt at any given time.
-

*interrupt priority*: in many architectures the interrupt inputs have built-in priority; an interrupt will not take effect during the execution of an interrupt handler at equal or higher priority. The MIPS hardware doesn't do this directly; but the system software can impose a priority on the interrupt inputs.

*interrupt*: an external signal which can cause an exception (if not masked).

*isolate cache*: the basic mechanism for D-cache maintenance. Puts the CPU into a mode where data loads/stores occur *only* to the cache and not to memory. In this mode partial-word stores cause the cache line to be invalidated. The Cache Management chapter details how to do the same to the I-cache.

*jump and link (jal) instruction*: MIPS instruction set name for a function call, which puts the return address (the "link") into *ra*.

*k0 and k1 registers*: two general-purpose registers which are reserved, by convention, for the use of trap handlers. It is difficult to contrive a trap handler which does not use at least one register before it saves it.

*kseg0 and kseg1*: the "unmapped" address spaces (actually they are mapped in the sense that the resulting physical addresses are in the low 512Mbytes). *kseg0* is for cached references, *kseg1* for uncached references. Standalone programs, or programs using simple OS, are likely to run wholly in *kseg0/kseg1*.

*KU*: the kernel/user privilege bit in the status register.

*kuseg*: the low half of the program address space, which is accessible by programs running with user privileges. The translation to a physical address is either through the TLB ("E" versions) or through a fixed translation ("base" versions).

*leaf function*: a function which itself contains no other function call. This kind of function can return directly through the *ra* register, and typically uses no stack space.

*level sensitive*: an attribute of a signal (particularly an interrupt signal) that says that the receiving logic will react if the signal is provided at a designated logic level (as opposed to "edge sensitive", whereby the receiving logic reacts to a *change* in the signal level). MIPS interrupt inputs are level sensitive; they will cause an interrupt any time they are active and unmasked.

*linker*: the program which joins together object code modules, resolving external references.

*little-endian*: describes an architecture where the least-significant part of a multi-byte integer is stored at the lowest byte address.

*lo, hi registers*: dedicated output registers of the integer multiply/divide unit. These registers are interlocked – an attempt to copy data from them into a general-purpose register will be stalled until the multiply/divide can complete.

*load delay slot*: the position in the instruction sequence immediately following a load. An instruction in the load delay slot cannot use the value just loaded (the results would be unpredictable). The compiler, assembler or programmer may move code around to try to make best use of load delay slots, or use a "nop" if the code can't be re-ordered.

*load delay*: see delayed loads.

*load/store architecture*: describes an ISA like MIPS, where memory data can be accessed only by explicit load and store instructions. Many other architectures define instructions (e.g. "push", or arithmetic on a memory variable) which implicitly access memory.

*loader*: the program which takes an object code module and assigns fixed program addresses to instructions and data, in order to make an executable file.

*logic analyzer*: a piece of test equipment which simultaneously monitors the logic level (i.e. as 1 or zero) of many signals. It is often used to keep a list of the addresses of accesses made by a microprocessor.

*loop unrolling*: an optimization used by advanced compilers. Program loops are compiled to code which can implement several iterations of the loop without branching out of line. This can be particularly advantageous on architectures (unlike MIPS) where a long pipeline and instruction prefetching makes taken branches costly. However, even on the MIPS architecture it can help by allowing intermingling of code from different loop iterations.

*macro instructions*: see instruction synthesis by assembler.

*mantissa*: a part of the representation of a floating point number.

*micro-TLB*: the MIPS TLB is dedicated to translating data addresses. Use of the TLB to translate addresses for I-fetch would lead to resource conflict and would slow the CPU. The micro-TLB remembers the last used I-fetch program pages, and physical pages, and saves a reference to the real TLB until execution occurs outside the two most recently referenced pages. When this happens, a 1-clock stall occurs while the micro-TLB is refilled from the data TLB.

*MIPS System VR3, RISC/os and Irix*: these are all ways of referring to the same basic operating system, a derivative of Unix System V Release 3. This OS supports "RISCware" applications.

*MIPS UMIPS 4.3BSD*: MIPS Corp.'s first operating system was a derivative of Berkeley's BSD4.3 version of Unix.

*MIPS*: used alternately to refer to the name of the company which originated this processor architecture, or the name of the architecture itself. It has another meaning, referring to "Millions of Instructions Per Second", a performance metric.

*MIPS/ABI*: the latest standard for MIPS applications, supported by all Unix system vendors using the MIPS architecture in big-endian form.

*MIPSCO*: MIPS Corporation, now the MIPS Technologies Inc. subsidiary of Silicon Graphics Corporation.

*MIPSEB and MIPSEL*: these are the words used to request big-endian and little-endian output (respectively) from the MIPS Co. compiler toolchain and some others.

*misaligned*: see unaligned.

*MMU, Memory management unit*: the only memory-management hardware provided in the MIPS architecture is the TLB which can translate program addresses from any of up to 64 pages into physical addresses. See TLB for details.

*NaN*: "not a number" - a special floating point value defined by IEEE754 as the value to be returned from operations presented with illegal operands.

*naturally aligned*: a datum of length  $n$  is naturally aligned if its base address is zero mod  $n$ . A word is naturally aligned if it is on a 4-byte boundary; a half-word if it is on a 2-byte boundary.

*noalias - noat - nobopt - nomacro - noreorder - novolatile*: assembler language controls, which turn off various aspects of the way the assembler works.

*non-leaf function*: a function which somewhere calls another function. Normally the compiler will translate them with a function prologue which saves the return address (and possibly other register values) on a stack, and a function epilogue which restores these values.

*nop*: no-operation. This is actually an alias for **slvw zero,zero,zero** - which will actually not do anything.

- nullified*: applied to an instruction which, although it has been started in the pipeline, will not be allowed to change the processor context. In general, instructions never change context until at least the MEM pipestage. In the R30xx family instructions are only nullified when an exception occurs before they have committed to the MEM stage.
- NVRAM*: non-volatile RAM, used rather generically to refer to any writable storage which is preserved while the system is powered down.
- object code*: a special file format containing compiled program source and data, in a form which can be quickly and easily converted to executable format.
- operand*: a value used by an operation.
- overflow*: when the result of an operation is too big to be represented in the output format, it is said to overflow.
- padding*: "spaces" left in memory data structures and representations, caused by the compilers' need to align data to the boundaries which the hardware prefers.
- page mode memory*: a way of using a DRAM memory array. In DRAMs it is much faster to make repeated access to a single region of memory where the "row" address presented to the DRAM component is common. R30xx family components give specific support to page mode access, particularly to speed writes.
- page table*: a possible implementation of the TLB miss exception is to keep a large number of page translations in a table indexed by the high-order virtual address; such a thing is called a page table.
- paged*: describes a memory management system (like MIPS) where fixed-size pages (in the R30xx "E" versions they are 4Kbytes in size) are mapped; high bits are translated while the low bits (11 bits for 4kB pages) are passed through unchanged.
- partial-word*: any transfer which is not a whole word. In the MIPS architecture this can be 1-, 2- or 3 bytes.
- PC-relative*: an instruction is PC-relative if it generates an address which is an offset from the instruction's own location.
- peephole optimization*: a form of optimization which recognizes particular patterns of instruction sequence and replaces them by shorter, simpler patterns. Peephole optimization is not terribly important for RISCs, but they are very important to CISCs – where they provide the only mechanism by which compilers can exploit complex instructions.
- PFN*: "page frame number" – the high-order part of the program address which is submitted to the address translation mechanism of a paged MMU.
- pipeline re-organization*: see peephole optimization.
- pipeline concealment by assembler*: MIPS assembler language does not usually require the programmer to take account of the pipeline – even though the machine language does. The assembler moves code around, or inserts "nop"s, to prevent unwanted behavior.
- pipeline hazard*: this is the name for a case where an instruction sequence won't work due to pipeline problems.
- pipeline*: the critical architectural feature by which several instructions are executed at once.
- pipestage*: one of the five phases of the MIPS pipeline.
- pixie, pixstats, and prof*: see profiling. *pixie* is a special tool provide by MIPS Corp., which can be used to measure the instruction-by-instruction behavior of programs at high speed. It works by translating the original program binary into a version which includes "metering"

instructions which count the number of times each *basic block* is executed (a basic block is a section of code delimited by branches and/or branch targets).

*pixstats* and *prof* take the huge indigestible array of counts produced by a *pixie* run and munches them down into useful statistics.

*PortSize register*: CPU control register provided on the R3041, and used to define the bus transfer width used for accesses in various regions.

*position-independent code (PIC)*: code which can execute correctly regardless of where it is positioned in program address space. This is usually produced by making sure all references are PC and/or GP-relative. PIC is an essential part of the MIPS/ABI standard, where sharable library code must be compiled position-independent.

*POSIX*: a still-evolving IEEE standard for the programming interface provided by a compliant operating system.

*PPN*: physical page number; the high order part of the physical address, which is the output of the paged MMU.

*pragma*: the C compiler “`#pragma`” directive is used to select compiler options from within the source code.

*precise exception*: the MIPS architecture offers precise exceptions. This means that, following an exception, all instructions earlier in instruction sequence than the instruction referenced by *EPC* are completed, whereas all instructions later in instruction sequence have not changed processor state.

*precision of data type*: the number of bits available for its representation.

*PRId register*: CPU control register (read-only) which tells the type and revision number of the CPU.

*primary cache*: in a system with more than one level of cache, this is the cache closest to the CPU. Most R30xx family implementations will have only one level of cache (the on-chip cache).

*privilege level*: CPUs capable of running a secure OS must be able to operate at different privilege levels. The MIPS CPU can operate at two: kernel and user.

*profiling*: running a program with some kind of instrumentation, to derive information about its resource usage and running.

*program address*: the software engineer’s view of addresses, as generated by the program. Also known as “virtual address”.

*PROM*: programmable read-only memory, used to mean any read-only program memory.

*quad-precision (128-bit) floating point*: not supported by R30xx hardware, but referred to in some documentation.

*R2000, R3000*: the original implementations of the MIPS ISA, packaged to use external static RAMs as cache.

*ra register*: CPU register \$31, conventionally used for the return address from subroutines. This use is supported by the ISA in that it is used by **jal** instruction (whose 26-bit target address field leaves it no room to specify which register should receive the return address value).

*Random register*: a CPU control register present only if there is a TLB. It increments continually and autonomously, and is used for pseudo-random replacement of TLB entries.

*ranlib*: a program used to maintain object-code libraries – it makes indexes.

*read buffer*: on a burst-mode cache read, the MIPS R3000A core used in the R30xx family needs to be fed with data at 1-clock intervals (once it is told to restart). A read buffer permits the actual memory timings

to be a little slower; the CPU fills the read buffer at memory speed and empties it at CPU speed. The R30xx family implements a read buffer on-chip to ease system hardware design.

*read priority*: because of the write buffer, the CPU may simultaneously want to do a read and a (delayed) write. It is possible, and can boost performance, to do the read first – the CPU will always be waiting for the read data; this is called “read priority”. But it causes coherency problems when the location being read is affected by a pending write; the R30xx uses read priority for I-Cache misses, but write priority for D-Cache misses and uncached fetches (I- or D-).

*reset*: used in this manual for the event which happens when the system activates the Reset\* input to the CPU; this happens at power-on or system reinitialization.

*rounding mode*: defines the exact behavior of floating point operations, and configurable through the floating point status/control register.

*s0-s9 register*: a collection of CPU general purpose registers (\$16-\$23 and \$30) conventionally used for variables of function scope, and which must be saved by any function which modifies them.

*secondary cache*: in a system with more than one level of cache, this is the cache second closest to the CPU.

*segment*: see kseg0/kseg1.

*software instruction emulators*: a program which emulates the operation of a CPU/memory system. It can be used to check out software too low-level to be compatible with a debugger.

*software interrupts*: interrupts invoked by setting bits in the Cause register, and which happen when those bits are unmasked.

*source-level debugger*: a debugger which interprets current program state in terms of the source program (instruction lines, variable names, data structures). Source-level debuggers need access to source code; so when working with embedded system software the debugger must run on the host, and obtains information about the program state from a simple “debug monitor” running on the target.

*sp register/stack pointer*: CPU register \$29, used by convention as a stack pointer.

*SR register*: CPU “status register”, one of the privileged control registers. Contains control bits for any modes which the CPU respects.

*SRAM*: static RAM – writable random-access memory which does not require periodic refresh, and typically has faster initial access time.

*SBrCond*: see BRCOND.

*stack argument structure*: a conceptual data structure used to explain how arguments are passed to functions according to the MIPS convention.

*stack backtrace*: a debugger function, which interprets the state of the program stack to show the nest of function calls which has got to the current position. Depends wholly on strict stack usage conventions, which assembler programs must notate with standard directives.

*stack frame*: a phrase for the piece of stack used by a particular function.

*stack underrun*: the error where software attempts to pop more off a stack than was ever put on it.

*stall*: the condition where the pipeline is frozen (no instruction state is advanced) while the CPU waits for some resource to become available.

*standalone software*: software operating without the benefit of any kind of operating system or standard run-time environment.

*strcpy*: C library function which copies a (null-terminated) string.



*strength reduction*: optimization technique where a time “expensive” operation is replaced, where possible, by one or a short sequence of “cheaper” operations. For example, multiply by a constant may be more efficiently replaced by a sequence of shift and add operations.

*swap caches*: temporarily reverse the roles of the I- and D-cache, so that the cache maintenance functions can operate on the I-cache. Controlled by a status register bit.

*swapper*: see byte-swapper.

*synthesized instructions*: see instruction synthesis by assembler.

*syscall*: system call – an instruction which produces a trap. It has a spare field, uninterpreted by the hardware, which software can use to encode different system call types.

*t0-t9 register/temporaries*: CPU registers \$8-\$15 and \$24-\$25, conventionally used as “temporaries”; any function can use these registers regardless. The values aren’t guaranteed to survive any function call.

*TLB (translation lookaside buffer)*: the 64-entry associative store which translates program to physical page numbers. When the TLB doesn’t contain the translation entry needed, the CPU takes an exception and it is up to system software to load an appropriate entry before returning to re-execute the faulting reference.

*TLB – wired entries*: the first 8 TLB entries are conventionally reserved for statically-configured entries, and are not randomly replaced.

*TLB Invalid exception*: the exception taken when a TLB entry matches the address, but is marked as not valid.

*TLB miss*: the exception taken when no TLB entry matches the program address.

*TLB Modified exception*: the exception taken when a TLB entry matches a store address, but that entry is not flagged as writable.

*TLB Probe*: an instruction used to submit a program address to the TLB to see what translations are currently in force.

*TLB refill*: the process of adding a new entry to the TLB following a miss.

*toolchain*: the complete set of tools required to produce runnable programs starting from source code (compiler, assembler, linker, librarian etc.).

*trap*: an exception caused by some internal event affecting a particular instruction.

*tribyte*: a load/store which carries 3 bytes of data. Produced only by the special instructions **lwl/lwr**.

*Ultrix*: DEC’s trade name for their BSD family operating system running on MIPS-based DECstation computers. Note that Ultrix, unlike practically all other MIPS Unix-like systems, runs in little-endian mode so is completely software-incompatible with MIPS/ABI or RISCware.

*unaligned access exception*: trap caused by a memory reference (load/store word or half-word) at a misaligned address.

*unaligned data*: data stored in memory but not guaranteed to be on the “proper” alignment boundary. Unaligned data can only be accessed reliably by special code sequences.

*uncacheable*: describes the region *kseg1* (which may never be cached) and translated address regions where the TLB entry is flagged as uncached.

*unimplemented instruction exception*: trap taken when the CPU does not recognize the instruction code; also used when it cannot successfully complete a floating point instruction and wants the software emulator to take over.

*union*: a "C" declaration of an item of data which is going to have alternative interpretations with different data types. This is highly non-portable.

*Unisoft V.4 - "Uniplus+"*: yet another version of Unix SVR4, this one MIPS/ABI compliant.

*unmapped*: describes the kseg0/kseg1 address spaces.

*utlbmiss*: a TLB miss exception caused by a user-privilege address for which no mapping is present in the TLB is vectored to a unique, second, exception entry point. This was done because this is by far the most common trap in a hard-working UNIX-like operating system, and it saves time to avoid the code which decodes which kind of trap has occurred.

*v0-v1 register*: CPU registers \$2-\$3, conventionally used to hold values being returned by functions.

*varargs*: a software mechanism, implemented by the compiler prompted by a special include file and macros, providing a portable way of defining and using functions with variable numbers of arguments.

*virtual address*: see program address.

*void*: a data type used to tidy up C programs, indicating that no value is available.

*volatile*: an attribute of declared data in either C or assembler. A volatile variable is one which may not simply behave like memory (i.e. does not simply return the value last stored in it). In the absence of this attribute, an optimizer may assume that it is unnecessary to re-read a value; and if the variable represents a memory-mapped IO location being polled, this will be a mistake. Most compiler optimizers will insure this does not happen to "volatile" data.

*watchpoint*: a debugger feature which causes the running program to be suspended and control passed back to the user whenever an access is made to the specified address.

*wbflush*: a standard name for the routine/macro which ensures that the write buffer is empty.

*wraparound*: some memory systems (including the MIPS cache when isolated) have the property that accesses beyond the memory array size simply wrap round and start accessing the memory again at the beginning.

*write buffer*: a FIFO store which keeps both the address and data of a CPU write cycle (the R30xx family contain four of each). The CPU can continue execution while the writes are carried out as fast as the memory system will manage.

A write buffer is particularly effective when used with a write-through cache.

*write-through cache*: a D-cache where every write operation is made both to the cache (if the access hits a cached location) and simultaneously to memory. The advantage is that the cache never contains data which is not already in memory, so cache lines can be freely discarded.

*zero register*: CPU register \$0, which is very special. Regardless of what is written to it, it always returns the value zero.